

RvP

Rudolf von Prusky

2021

LED Profile

LED profiles



ABDECKUNGEN / COVERS

A einschiebbar / slide
opal, satiniert, transparent
opal, frosted, transparent

B einschiebbar / slide
opal, satiniert, transparent
opal, frosted, transparent

C einclipsbar / click
opal, transparent
opal, transparent

C Linse / lens
transparent
transparent

C1 einclipsbar / click
opal
opal

C2 einclipsbar / click
opal, transparent
opal, transparent

C3 einclipsbar / click
opal, transparent
opal, transparent

D einclipsbar / click
opal
opal

E einschiebbar / slide
opal, satiniert, transparent
opal, frosted, transparent

E7 einclipsbar / click
opal
opal

F einclipsbar / click
opal, transparent
opal, transparent

G einschiebbar / slide
opal, satiniert, transparent
opal, frosted, transparent

H einschiebbar / slide
opal, satiniert, transparent
opal, frosted, transparent

I einclipsbar / click
opal, satiniert
opal, frosted

J einschiebbar / slide
opal, satiniert, transparent
opal, frosted, transparent

K einclipsbar / click
opal
opal

BEFESTIGUNGEN / MOUNTINGS

T
Halter T
T mounting plate

Verbindungsstück T 180 Grad
T connector 180 deg

U
Halter U flexibel
U flexible mounting plate

Halter U flexibel cone
cone U flexible mounting plate

Halter U flexibel rack
rack U flexible mounting plate

W
Halter W flexibel cone
cone W flexible mounting plate
weiß, inox, schwarz
white, inox, black

X
Halter X
X mounting plate

Verbindungsstück X 180 Grad
X connector 180 deg

Y
Halter Y flexibel
Y flexible mounting plate

Halter Y flexibel cone
cone Y flexible mounting plate

Z
Halter Z flexibel
Z flexible mounting plate
weiß, inox, schwarz
white, inox, black

Halter Z flexibel cone
cone Z flexible mounting plate
weiß, inox, schwarz
white, inox, black



LED Profile von LED profiles

Schritt für Schritt / Tutorial 1.01



LED Aufbauprofile surface LED profiles

SLIM8 AC2/Z	2.01
SMART10 AC2/Z	2.05
SURFACE10 BC/UX	2.09
BEGTON12 J/S	2.13
UNI12 BCD/U	2.17
SURFACE14 EF/TY	2.21
SMART16 BC3/U4	2.25
LINEA20 EF/TY	2.29
WIDE24 G/W	2.41

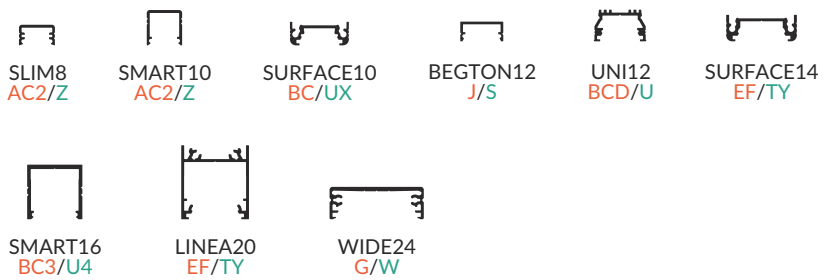

LED Einbauprofile recessed LED profiles

FLAT8 H/UX	3.01
HI8 C1	3.05
SLASH8	3.09
DEEP10 BC/UX	3.13
GROOVE10 BC/UX	3.17
SMART-IN10 AC2/Z	3.21
BEGTIN12 J/S	3.25
FLOOR K	3.29
FLOOR8 K	3.31
FLOOR12 K/U	3.33
GROOVE14 EF/TY	3.35
SMART-IN16 BC3/U4	3.39
LINEA-IN20 EF/U7	3.43
LINEA-IN20 TRIMLESS EF/U7	3.50

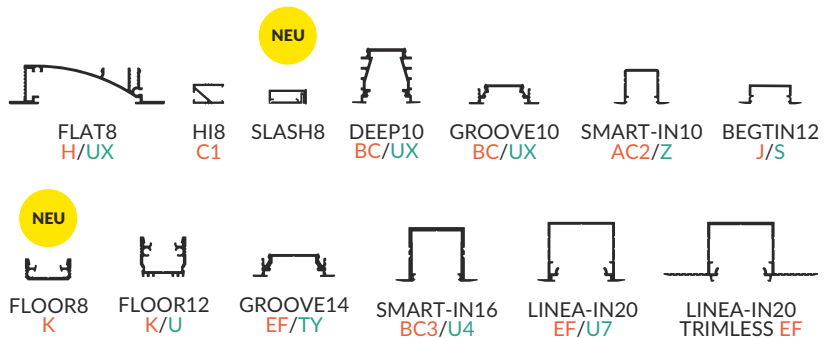

LED Eckprofile corner LED profiles

TRIO10 BC	4.01
CORNER10 BC/UX	4.05
QUARTER10 BD/U6	4.09
CABI12 E	4.13
CORNER14 EF/TY	4.17
CORNER27 G/UX	4.21

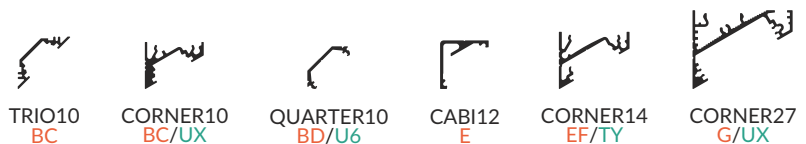

spezielle LED Profile special application LED profiles

PEN8 I	5.01
BACK10 A/UX	5.05
STEP10 C	5.09
WAY10 C	5.13
ARC12 CD/U5	5.17
FIX12 / FIX16	5.21
WALLE12 BCD	5.23
PEN12 CJ	5.27
UNI-TILE12 C	5.31
FRAME14 BC/Q	5.37
OVAL20 BC	5.41

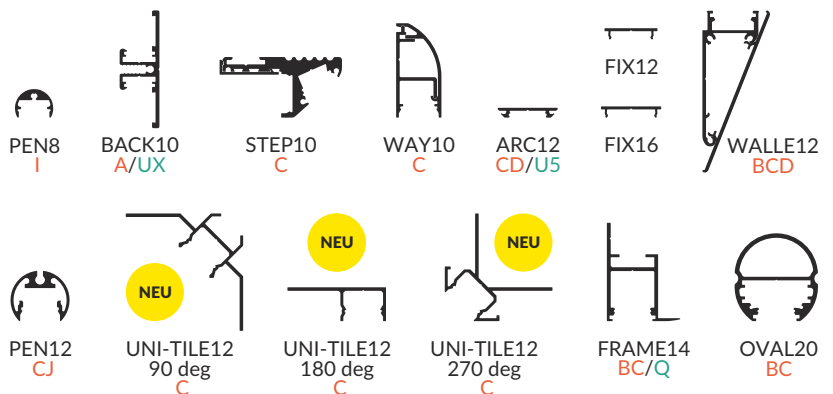

LED Glaskantenprofile glass application LED profiles

TWIN8	6.01
MIKRO10	6.03
EDGE10 BC	6.05
MIKRO-LINE12 J	6.09

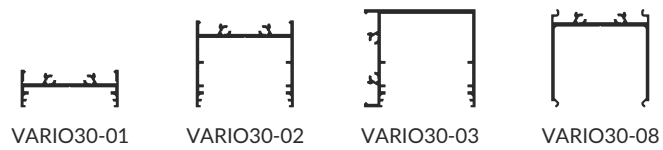
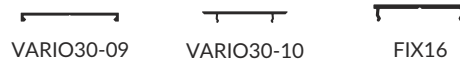
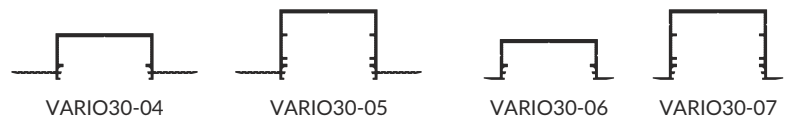

VARIO30	7.01
VARIO30-01	7.06
VARIO30-02	7.06
VARIO30-03	7.06
VARIO30-08	7.06
VARIO30-09	7.07
VARIO30-10	7.07
FIX16	7.07
VARIO30-04	7.14
VARIO30-05	7.14
VARIO30-06	7.14
VARIO30-07	7.14

AUFBAUPROFILE / SURFACE**EINSPEISUNGSPROFIL
POWER SUPPLY PROFILE****HILFSPROFILE
ASSISTANT PROFILES****EINBAUPROFILE ZUM VERPUTZEN
RECESSED - SPACKLE FLANGE MOUNTING****EINBAUPROFILE
RECESSED****Große Profile
big profiles**

PHIL53	8.01
PHIL für Einbau / PHIL recessed	8.02
LOWI	8.02

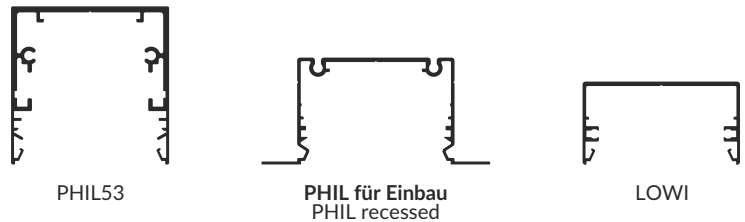
**LED Zubehör
LED accessories**

Abhängungen für die LED Profile / LED profile slings	9.01
Gelenkhalter für die LED Profile / tilted bracket for LED profiles	9.01
weiteres Zubehör / other accessories	9.02

**allgemeine Informationen
general information**

Profilübersicht / profile overview	10.01
------------------------------------	-------

Typen der LED Profile / profile categories



AUFBAUPROFILE / SURFACE

LED Profile mit der universellsten Anwendung. Die Montage auf einer flachen Oberfläche erfolgt am meisten mit Hilfe von Aluminium- oder flexiblen Stahlhaltern, aber auch mit Schrauben, Montagebänder. Bemerkenswert sind folgende Profile: SURFACE10, SURFACE14, LINEA20 - versteckte Befestigung.

LED profiles with the most universal applications. Installation on a flat surface, most commonly with the use of aluminium holders or steel flexible mounting plates but also with the use of screws, or assembly tapes. It is worth to note the profiles with hidden mounting: SURFACE10, SURFACE14 and LINEA20.

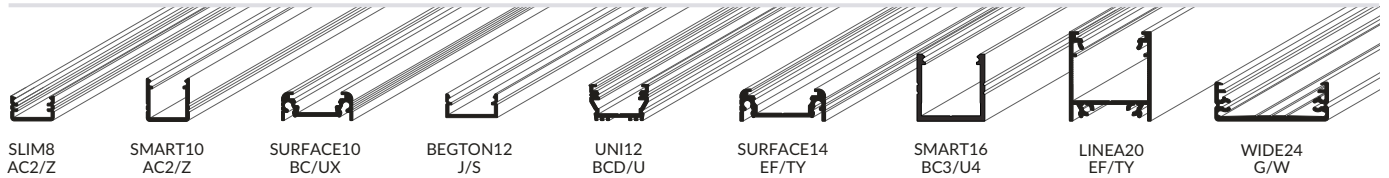

EINBAUPROFILE / RECESSED

Ein Vorteil des Einbauprofils ist das Erreichen einer Lichtfläche, die nahezu mit der Oberfläche der Wand oder des Möbels zusammenpasst. Die Montage der Profile verlangt einer Vorbereitung der Oberfläche - das Ausschneiden einer länglichen Öffnung in einem Möbelstück (HI8, SLASH8, GROOVE10, BEGTIN12, GROOVE14), in einer Rigipsplatte (FLAT8, DEEP10) oder die Abstandbildung bei dem Auslegen von Fliesen (FLOOR8, FLOOR12).

The advantage of recessing a profile is obtaining an illuminating surface which almost levels with the plane of the wall or furniture. Profile installation requires surface preparation - cutting a longitudinal opening in the furniture (HI8, SLASH8, GROOVE10, BEGTIN12, GROOVE14), a plasterboard (FLAT8, DEEP10) or leaving an appropriate distance when installing the tiles (FLOOR8, FLOOR12).

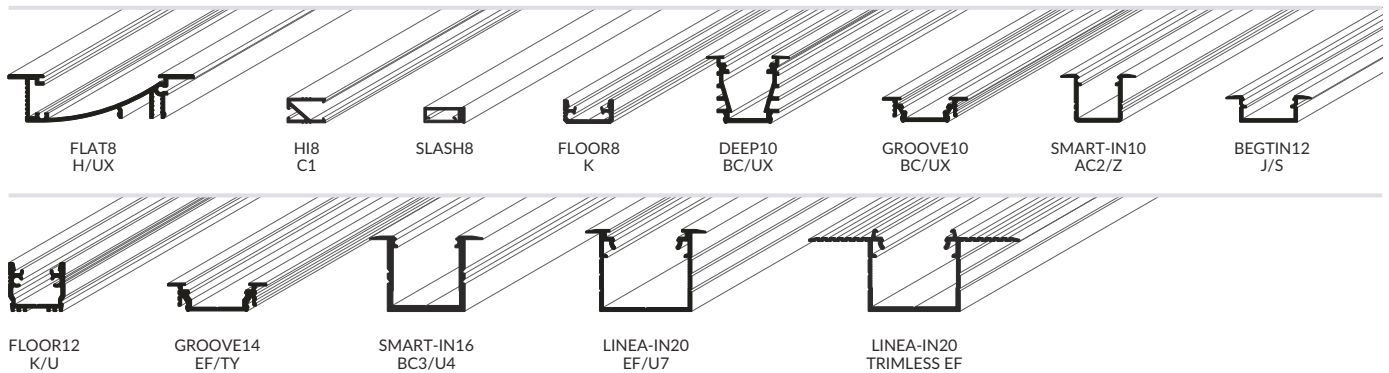

ECKPROFILE / CORNER

Für die Anwendung in den Wand-, Möbel- und Vitrinenecken. Die Montage mit Hilfe von Haltern, Schrauben, Montageband. Von Vorteil in den Profilen CORNER10, CORNER14 und CORNER27 ist die versteckte Befestigung. Die Profile ermöglichen einen Lichtwinkel von 30° oder 60° gegenüber der Montagefläche. Das Profil CABI12 wurde für Glasvitrinen entworfen, Montage mit Klebstoff. Es ermöglicht die Blendung zu vermeiden. Die Montage unter einem Winkel von 30° oder 60°. Dank einem symmetrischen Durchschnitt kann man die Profile an den Ecken unter dem Winkel von 90° zusammenfügen. TRIO10, QUARTER10 - geeignet für die Beleuchtung unter dem Winkel von 45°.

To be used in the corners of wall, furniture and cabinets. Installation with mounting plates, screws, assembly tape. The asset of the CORNER10, CORNER14 and CORNER27 collections is the hidden mounting. These profiles provide a possibility to direct the light at an angle of 30° or 60° to the assembly plane. The CABI12 profile is designed for glass cabinets, then adhesive mounted. It allows to avoid glare. Installation at an angle of 30° or 60°. Thanks to the symmetric cross-section, the profiles can be joined in the corners at an angle of 90°. TRIO10, QUARTER10 - for lighting at an angle of 45°.





SPEZIELLE PROFILE / SPECIAL APPLICATION

Eine Gruppe von Profilen mit breiten Anwendungsmöglichkeiten: Wand-, Decken-, Treppen-, Garderobenprofile oder architektonische Profile. Entworfen für Spezialanwendungen.

Unter den Profilen befindet sich das Profil PEN8 mit der größten Zahl von Montagehaltern (u.a. Ausleger, Dübelhalter, flache und einfache Halter) zum Bilden von einer Reihe von Variationen und zum Erreichen von bestimmten Lichteffekten.

A group of profiles with a broad application spectrum - for the ceiling, wall, architectural, stair, wardrobe. Designed for special applications. Among them, the PEN8 with the highest number of holders (i.a.: extension arms, flat, simple and stretcher holders) for creating a number of combinations and achieving the defined illumination effects.

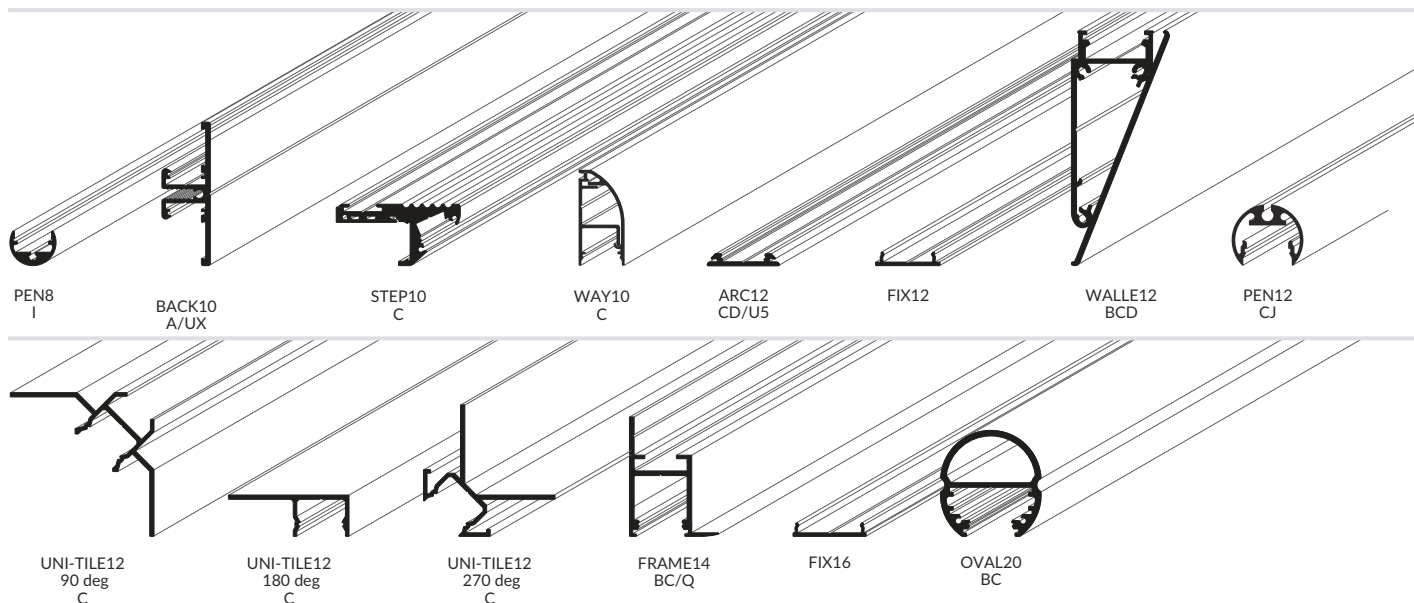

GLASKANTENPROFILE / GLASS APPLICATION

Die Glaskantenprofile dienen zur Präsentation von Gegenständen in den Vitrinen, erleuchten eine sandgestrahlte Werbegrafik oder dekorative Grafik. Montage auf der Kante einer Glasscheibe. Die Profile dienen nicht als ein Konstruktionsteil zum Halten des Bretts. EDGE10 - im Gegenteil zu den anderen - wird das Profil auf die Vorderseite des Bretts gelegt, was eine bessere Beleuchtung von dem Ausstellungsstück unten oder über dem Brett ermöglicht (nach der Drehung des Profils um 180°).

Profiles for glass are used to exhibit objects in cabinets and to illuminate the sanded advertising or decorative graphics. Installed on the edge of the glass panel, they do not constitute a shelf supporting structure. EDGE10 - in contrast to the other ones - is applied on the face of the shelf, which allows to better light up the exhibits under the shelf or above it (after rotating the profile by 180°).



Was sagt uns der Name des Profils?
What does a profile name indicate?

SURFACE10 BC/UX

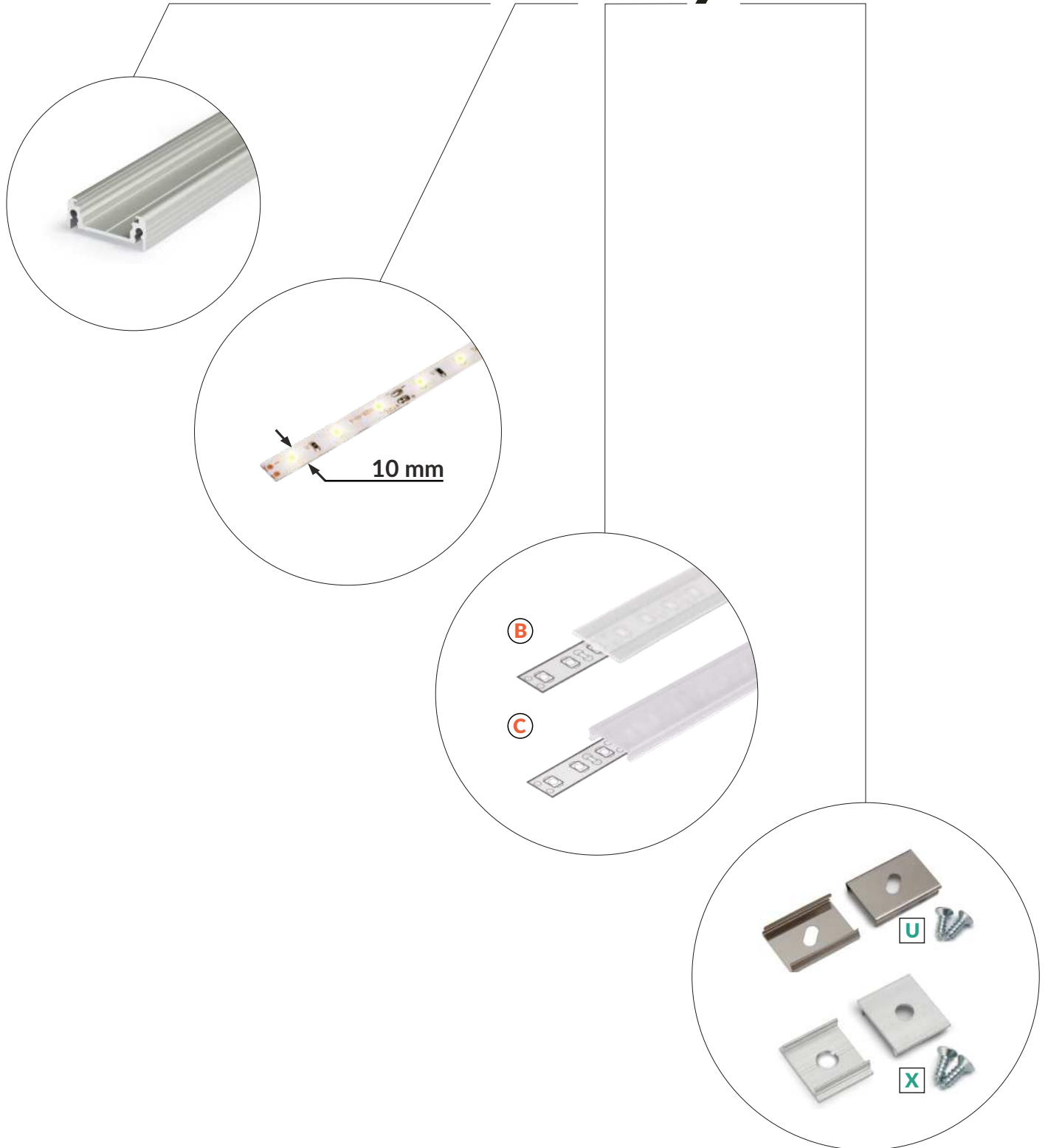

Slick

In unserem Sortiment haben wir auch LED Profile mit einem Slick Befestigungssockel. Diese Funktion ermöglicht ein einfaches Einclippen oder Einschieben der Abdeckung.

We also have profiles with the Slick socket in our assortment. This feature allows to click in or slide in the cover.

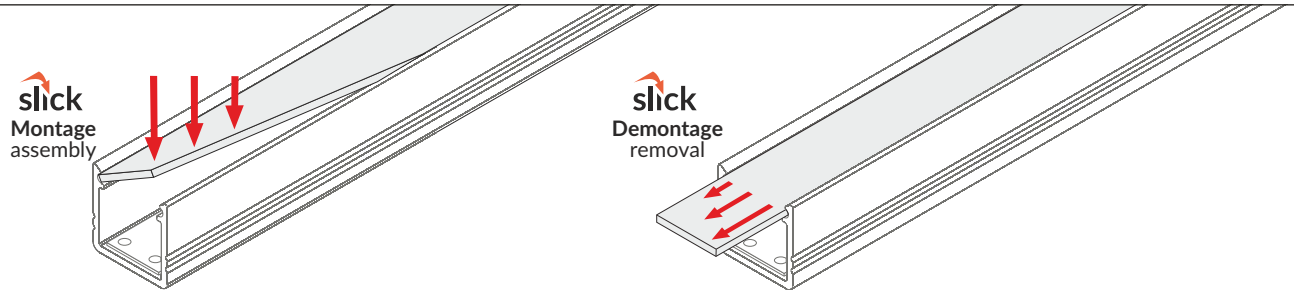

Unten befinden sich die Profile mit der Slick Funktion:
Profiles with Slick socket:

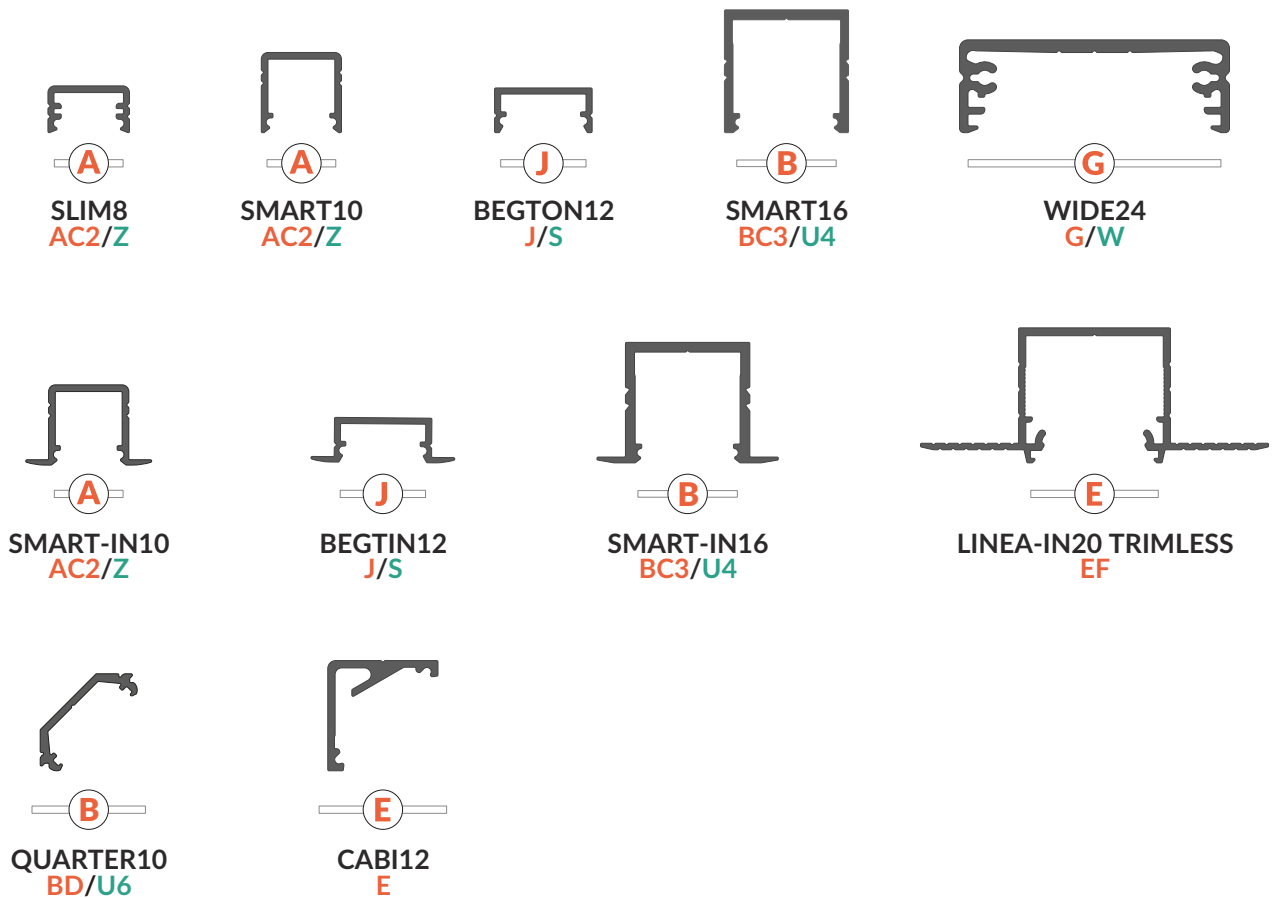

Wie wählt man die Abdeckung? / How to select a cover?

Die Abdeckungen für die LED Profile unterscheiden sich mit dem Grad der Lichtdurchlässigkeit. Eine bewusste Wahl ermöglicht den Lichteffekt, die Lichtstreuung und Lichtverteilung besser einzuplanen. Die transparente Abdeckung nimmt am wenigsten Licht auf, danach folgt die satinierte und opale Abdeckung.

Covers for aluminium LED profiles differ in the degree of transparency. Thanks to a conscious choice, you can plan the lighting effect, light dispersion and distribution better. A transparent cover absorbs a smaller amount of light, followed by frosted and opal ones.

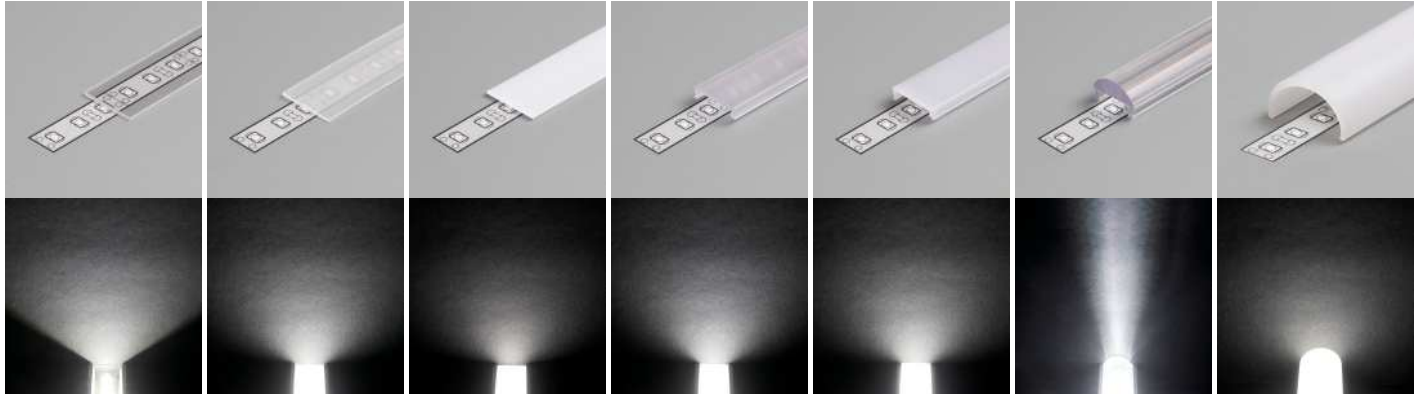

B einschiebbar transparent
B slide transparent

B einschiebbar satiniert
B slide frosted

B einschiebbar opal
B slide opal

C einclipsbar transparent
C click transparent

C einclipsbar opal
C click opal

C click lens
C klik soczewka

D einclipsbar opal
D click opal

SPEZIALABDECKUNGEN

Es ist auch sinnvoll sich mit interessanten Lichteffekten vertraut zu machen, die durch spezielle Abdeckungen ermöglicht werden.

SPECIAL COVERS

Familiarise yourself with the interesting lighting effects provided by more specialised diffusers.

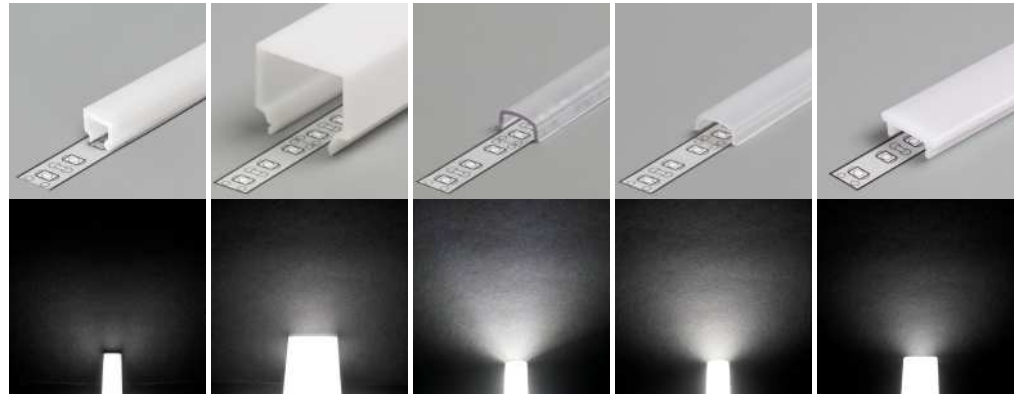

C1 einclipsbar opal
C1 click opal

HI8 _____ >3.05

E7 einclipsbar opal
E7 click opal

LINEA20 _____ >2.29
LINEA-IN20 _____ >3.43
LINEA-IN20 _____ >3.51
TRIMLESS
SURFACE14 _____ >2.21
GROOVE14 _____ >3.35
CORNER14 _____ >4.17

I einclipsbar satiniert
I click frosted

PEN8 _____ >5.01

I einclipsbar opal
I click opal

PEN8 _____ >5.01

K einclipsbar opal
K click opal

FLOOR8 _____ >3.31
FLOOR12 _____ >3.33

Dadurch ist auch die Sichtbarkeit von LEDs unterschiedlich. Wenn man in einigen Profilen opale Abdeckungen und ein LED Streifen mit 120 LEDs anwendet, gibt es den Effekt einer homogenen Lichtlinie.

It also means a different degree of visibility of LED points. Opal covers in some profiles, in conjunction with a 120 P/m tape, allow to achieve the effect of a continuous line of light.

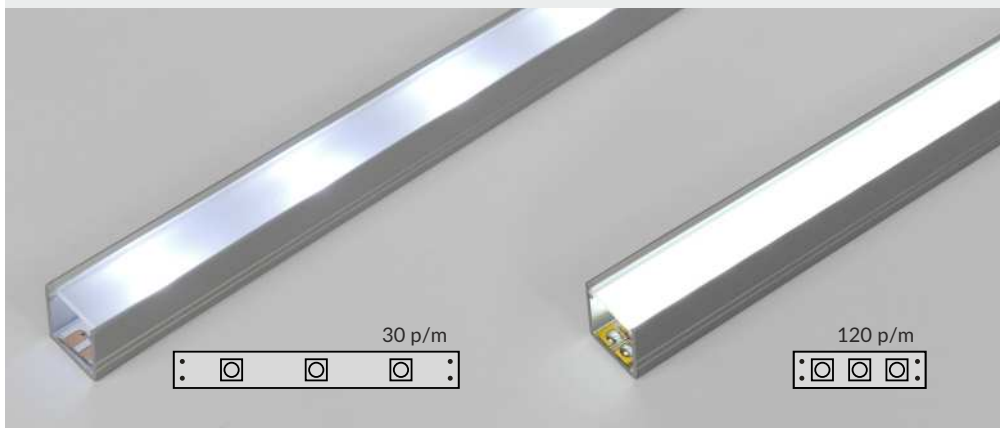

Hinweis / Tip:

Wenn wir homogene Lichtlinie in einem flachen Profil erzielen möchten, empfiehlt sich die Verwendung eines sehr dichten LED Streifens mit 240 LEDs/m.

If we want to obtain a continuous line of light with a shallow profile, it is worth to use a very dense LED strip 240 P/m.

Die Abdeckungen unterscheiden sich auch durch die Art und Weise der Montage.

ABDECKUNG ZUM EINSCHIEBEN (Bezeichnung: A, B, E, G, H, J)
Dies ist ein Streifen aus Kunststoff mit drei unterschiedlichen Graden der Lichtdurchlässigkeit. Man soll die Abdeckung vom Anfang des Profils einschieben und entlang des markierten Sockels ziehen oder in die Slick Befestigungssockel einclippen.

ABDECKUNG ZUM EINCLIPSEN (Bezeichnung: C, C1, C2, C3, D, E7, F, I, K)
Die Montage und Demontage der Abdeckung ist bequemer. Der Zugang zu den Enden des Profils ist nicht notwendig, was das Einclippen der Abdeckung sogar nach der Montage des Profils in einer Nische oder einem Möbelstück ermöglicht.

The covers also differ in the method of assembly.

SLIDE COVER (labelling: A, B, E, G, H, J)
It is a strip of plastic available in 3 different degrees of transparency. It needs to be slid from the beginning of the profile and dragged along the marked socket or clicked in the Slick socket.

CLICK COVER (labelling: C, C1, C2, C3, D, E7, F, I, K)
Its assembly and removal are more convenient. Access to the ends of the profile is not necessary, which allows to click in the cover even after installing the profile in a recess or a piece of furniture.



Viele von den Abdeckungen aus dem Sortiment gelten als kompatibles Zubehör. Dies bedeutet, dass dieselbe Abdeckung mit mehreren Profilen zusammenpasst.

Bei dem richtigen Anpassen der Abdeckungen helfen die Buchstaben. Dementsprechend passen z. B. mit dem LED Profil SURFACE10 BC/UC folgende Abdeckungen zusammen:

- B zum Einschieben
- C zum Einclippen
- C Linse

Die Abdeckung C zum Einclippen passt wiederum mit folgenden Profilen zusammen:

- SURFACE10 BC/UX
- UNI12 BCD/U
- GROOVE10 BC/UX
- DEEP10 BC/UX
- TRIO10 BC
- CORNER10 BC/UX
- STEP10 C
- WAY10 C
- WALLE12 CD
- ARC12 CD/U5
- PEN12 CJ
- UNI-TILE12 C
- FRAME14 BC/Q
- OVAL20 BC
- EDGE10 BC

Many of the covers in the assortment are system accessories. It means that one cover fits a few, different profiles.

A letter describing the socket helps correct matching. And so, e.g., the SURFACE10 BC/UX profile can be fitted with the covers:

- B slide
- C click
- C lens

Cover C click, on the other hands, fits the profiles:

- SURFACE10 BC/UX
- UNI12 BCD/U
- GROOVE10 BC/UX
- DEEP10 BC/UX
- TRIO10 BC
- CORNER10 BC/UX
- STEP10 C
- WAY10 C
- WALLE12 C
- ARC12 CD/U5
- PEN12 CJ
- UNI-TILE12 C
- FRAME14 BC/Q
- OVAL20 BC
- EDGE10 BC

Rolle 20 m 20 m reel

Lange Lichtlinien ohne Spalten.
Minimalisieren von Abfallabschnitten.
Für Abdeckungen C und F einclipsbar opal
führen wir 20 m lange Profilrollen, verpackt in
einem praktischen Karton.

Long lines of light without connection gaps.
Minimizing cutting waste.
For C and F click opal covers
we introduce 20 metre long lengths,
rolled up on a reel,
packed in a convenient cartonbox.



C2 einclipsbar / click

Abdeckungen einclipsbar für Profile:
Click covers for profiles:

SLIM8
SMART10
SMART-IN10

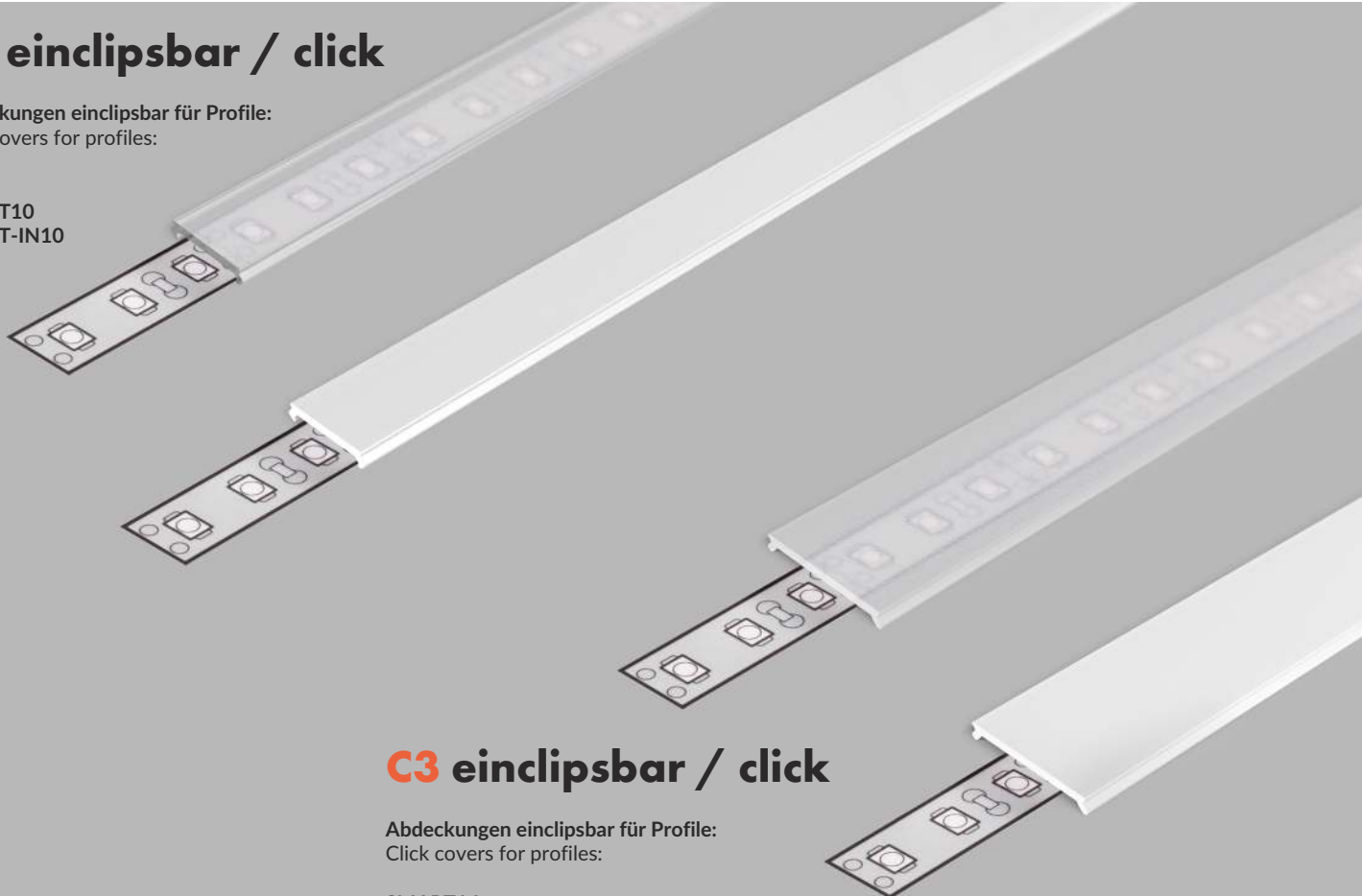

C3 einclipsbar / click

Abdeckungen einclipsbar für Profile:
Click covers for profiles:

SMART16
SMART-IN16

SCHWARZ IST WEISS BLACK IS WHITE

NEU

SCHWARZE ABDECKUNGEN C, F

BLACK COVERS C, F

- Lichtdurchlässigkeit auf 70% Niveau
- Die Abdeckung ändert die Lichtfarbe nicht
- 70% light transmission
- the cover does not change the colour of the light



Achtung! Sie erreichen den besten Effekt, indem man schwarze Abdeckungen mit schwarzen LED Profilen verwendet
Note! The best effect is achieved by using black covers with black LED profiles

Vergleich der schwarzen Abdeckung mit der opalen Abdeckung Comparison of black and opal cover

Länge 2.000 mm, length 2000 mm

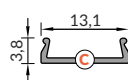
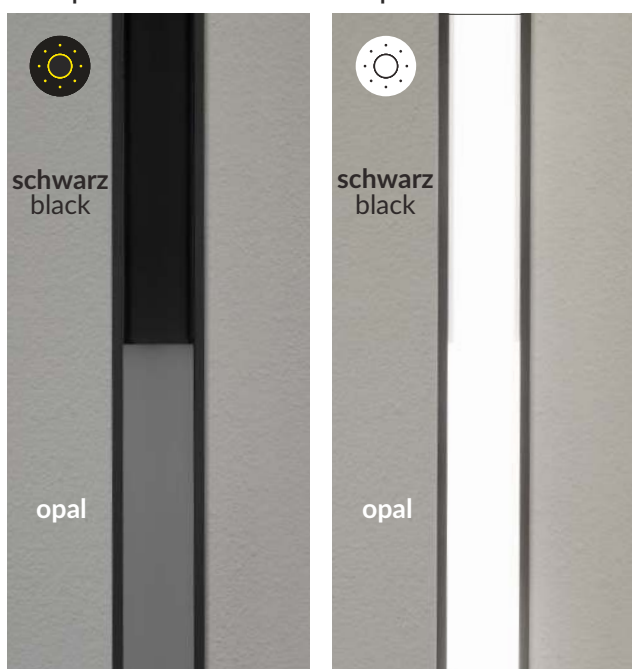

Abdeckung C einclipsbar
Farben: schwarz
Material: PMMA
C click cover
colour: black
material: PMMA

Artikelnummer = 1 Stück / index = 1 pc
9576330041

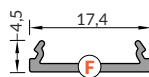

Abdeckung F einclipsbar
Farben: schwarz
Material: PMMA
F click cover
colour: black
material: PMMA

Artikelnummer = 1 Stück / index = 1 pc
95A2060041

Die Toleranz der Länge von Abdeckungen beträgt: +20 mm.
Mehr Informationen >> 1.08.
The standard cover length tolerance is +20 mm.
More details >> 1.08.

Vergleich der technischen Parameter C und F Comparison of technical parameters of C and F covers

Die Art der Abdeckung cover type	Das Material material	Die Anwendungstemperatur work temperature		UV- Beständigkeit UV resistance	Das Zertifikat für Brennbarkeit nach PN-EN 60695-2-11 fire hazard certificate according to IEC 60695-2-11	Lichtdurch- lässigkeit transparency	Lichtst- reuungsfaktor coefficient diffusion
		min [°C]	max [°C]				
C F transparent transparent	PMMA	-20	70	✓	✓	93%	niedrig low
C F opal opal	PMMA	-20	70	✓	✓	75%	niedrig low
C F schwarz black	PMMA	-40	75	✓	✓	70%	mittel medium

NEU

Abdeckungen / Covers

Die angebotenen Abdeckungen unterscheiden sich untereinander nicht nur im Lichteffect, sondern auch durch die technischen Parametern. Innerhalb den Spezialabdeckungen zeichnet sich besonders eine Abdeckung aus - die für Profile LED FLOOR8 und FLOOR12 bestimmt ist, d.h. die Abdeckung K opal. Ihr charakteristisches Merkmal ist eine hohe Beständigkeit gegen Beschädigungen und Schlagbeständigkeit von IK08. Dies ermöglicht das Betreten der Abdeckung ohne die Gefahr, dass es zerspringt oder zerkratzt wird.

The covers in the offer differ between one another not only in terms of the achieved lighting effect but also in terms of technical parameters. Among the special cover, one stands out in particular - designed for the FLOOR8 and FLOOR12 LED profiles, the K opal cover. Its characteristic feature is the high resistance to damage and impacts with a degree of IK 08. This is why it is possible to tread over it - without having to worry about cracking or scratching.

Die Art der Abdeckung cover type	Das Material material	Die Anwendungstemperatur work temperature		UV- Beständigkeit UV resistance	Das Zertifikat für Brennbarkeit nach PN-EN 60695-2-11 fire hazard certificate according to IEC 60695-2-11	Lichtdurch- lässigkeit transparency	Lichtst- reuungsfaktor coefficient diffusion
		min [°C]	max [°C]				
(A) (B) (E) (G) (H) (J) transparent transparent	PC	-50	100	✓	✓	93%	niedrig low
(A) (B) (E) (G) (H) (J) satiniert frosted	PP	-15	85	✓	✓	90%	niedrig low
(A) (B) (E) (G) (H) (J) opal opal	PP	-15	85	✓	✓	70%	hoch high
(C) (F) transparent transparent	PMMA	-20	70	✓	✓	93%	niedrig low
(C) (F) opal opal	PMMA	-20	70	✓	✓	75%	niedrig low
(C) Linse lens	PC	-50	100	✓	✓	90%	niedrig low
(C1) opal opal	PMMA	-20	70	✓	✓	70%	hoch high
(C2) (C3) transparent transparent	PMMA	-25	120	✓	✓	93%	niedrig low
(C2) (C3) opal opal	PMMA	-25	120	✓	✓	75%	niedrig low
(D) opal opal	PMMA	-20	70	✓	✓	70%	hoch high
(E7) opal opal	PMMA	-20	70	✓	✓	70%	hoch high
(I) satiniert frosted	PC	-50	100	✓	✓	90%	niedrig low
(I) opal opal	PC	-50	100	✓	✓	80%	mittler medium
(K) opal opal	PC	-50	100	✓	✓	60%	hoch high

Toleranz / Tolerance

Wir sind darum sehr bemüht, dass eine maximale Wiederholbarkeit unserer Produkte eingehalten wird. Trotzdem können zwischen den jeweiligen Partien geringfügige Unterschiede vorkommen, die auf die Spezifik des Herstellungsverfahrens zurückzuführen sind. Deswegen empfehlen wir immer die vorliegenden Toleranzen zu berücksichtigen.

We make every effort to maintain maximum repeatability of our products. Despite this, there may be small differences between the individual batches due to the nature of the manufacturing processes. That is why we always recommend considering the following tolerances.

LÄNGE		Standardmäßige Toleranz*
PROFILE		+3 mm
ABDECKUNG ZUM EINCLIPSEN: 1 m, 2 m, 3 m (außer der unten erwähnten)		+5 mm
ABDECKUNG ZUM EINCLIPSEN: 2 m - C9, D9, E7, E9		+20 mm
ABDECKUNG ZUM EINCLIPSEN: 4 m		+150 mm
ABDECKUNG ZUM EINSCHIEBEN		+20 mm

*Es gibt die Möglichkeit der Produktvorbereitung in der eingeengten Spezialtoleranz. Nach den Details fragen Sie bitte Ihren Handelsbetreuer. Produkte werden bei der Temperatur von 20°C geschnitten.

LENGTH		Standard tolerance*
PROFILES		+3 mm
CLICK COVERS: 1 m, 2 m, 3 m (except listed below)		+5 mm
CLICK COVERS: 2 m - C9, D9, E7, E9		+20 mm
CLICK COVERS: 4 m		+150 mm
SLIDE COVERS		+20 mm

*It is possible to prepare product with a narrowed, special tolerance. Please ask your key account manager for details. Cutting of the products is carried out at a temperature of 20°C.

TEMPERATURDEHNUNG		Der Wert ist für den Unterschied von 10°C pro Laufmeter angegeben
PROFILE		bis zu ~0,2 mm
ABDECKUNG	C10 NARROW:	bis zu 0,7 mm
	C10 WIDE:	bis zu 0,7 mm
	C10 OPAL:	bis zu 0,8 mm
	sonstige:	0,2~0,3 mm

TEMPERATURE EXPANSION		Value stated for the difference of 10°C, per linear metre
PROFILES		up to ~0,2 mm
COVERS	C10 NARROW:	up to 0,7 mm
	C10 WIDE:	up to 0,7 mm
	C10 OPAL:	up to 0,8 mm
	others:	up to 0,2~0,3 mm

DURCHMESSER	
Alle angegebenen Profile unterliegen der Toleranz gemäß der Norm PN-EN 755-9.	

DIMENSIONS OF CROSS SECTION	
For all provided profile dimensions we apply tolerances in accordance with PN-EN 755-9.	

FARBE	
ELOXIERTE OBERFLÄCHEN	silbern: C-0
	schwarz: C-35
LACKIERTE OBERFLÄCHEN (anhand der RAL Palette)	weiß: RAL 9003 matt
	schwarz: RAL 9005 matt

COLOUR	
ANODIZED SURFACES	silver: C-0
	black: C-35
PAINTED SURFACES (according to the RAL palette)	white: RAL 9003 mat
	black: RAL 9005 mat

Montagezubehör / Mounting accessories

KOMPATIBLES ZUBEHÖR - passt mit vielen unterschiedlichen Profilen zusammen.

SPEZIELLES ZUBEHÖR - angepasst an einen Profiltyp, in der Regel dient es einer bestimmten Art und Weise der Montage: zum Aufhängen, auf einem Ausleger, unter einem Winkel usw.

SYSTEM ACCESSORIES - fit many different profiles.

DEDICATED ACCESSORIES - matched to one profile, are usually used for a more precise assembly method: pendant, on an extension arm, at an angle, etc.

MONTAGEHALTER / MOUNTING PLATES, HOLDERS

flexibel / flexible



Halter **U** flexibel
U flexible mounting plate



Halter **U** flexibel cone
cone U flexible mounting plate



Halter **U** flexibel rack
rack U flexible mounting plate

aus Aluminium / aluminium



Halter **X**
X mounting plate



Halter **T**
T mounting plate

einfach - für eine senkrechte Montage in der Möbelplatte (in einem Schrank)
simple - for perpendicular assembly in a furniture board (cabinets)



Halter **SLIM8** einfach
SLIM8 simple holder



Halter **SURFACE10** einfach
SURFACE10 simple holder



Halter **WIDE24** einfach
WIDE24 simple holder



Halter **PEN8** einfach
PEN8 simple holder



Halter **OVAL20** einfach
OVAL20 simple holder

konische oder längliche Öffnung?
„cone” or „slot”?

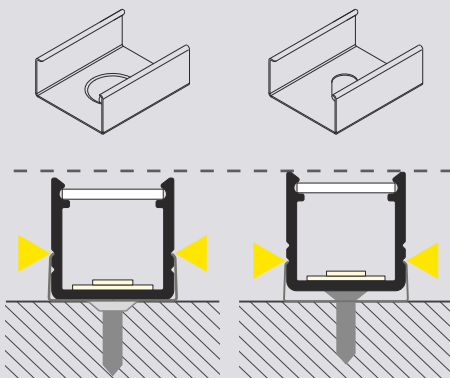

AUSLEGER / EXTENSION ARMS



Doppelausleger für OVAL20
OVAL20 double extension arm



Doppelhalter mit Gewinde für PEN8
PEN8 double holder with thread



Gelenkhalter mit Deckenhalter für PEN8
PEN8 jointed holder with soffit ceiling

VERBINDUNGSTÜCKE / CONNECTORS

Eine einfache Art und Weise der Verbindung von zwei Profilen in einer Linie oder mit einem bestimmten Winkel.
Easy method of joining 2 profile sections in a straight line or at a defined angle.



Verbindungsstück X 180 Grad
X connector 180 deg



Verbinder 90 Grad für SURFACE10
SURFACE10 connector 90 deg



Verbindungsstücke für LINEA20
LINEA20 connectors:

60°

90°

120°

135°

180°



Verbindungsstück T 180 Grad
T connector 180 deg



Verbinder 90 Grad für GROOVE10
GROOVE10 connector 90 deg

Verbindungsstücke für LINEA20 gebogen
LINEA20 bent connectors:

90°

270°



Verbinder 90 Grad für CORNER10
CORNER10 connector 90 deg

ABHÄNGUNGEN / SLINGS

Es ermöglicht den Bau von Pendelleuchten. Besonders empfohlen sind sie für das LED Profil LINEA20 (s. Seite 2.29-2.40), aber sie sind auch mit der Mehrheit der Profile kompatibel.
They enable creating pendant luminaires. They are especially recommended for the LED LINEA 20 profile (see pages 2.29-2.40) but are also compatible with most of the profiles.

MAX
50 V



Abhängung SELV 50 V 1500
SELV sling 50 V 1500



Abhängung für LED Profil-Halter 1500
sling for LED mounting 1500

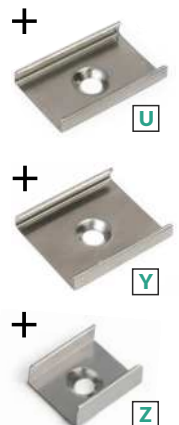

Endkappen / Endings

Die Endkappen erfüllen die Funktion von ansprechenden Profilschlüssen und dem zusätzlichen Schutzes der LED Lichtquelle. Die Endkappen sind in vier Grundfarben lieferbar: silbern, weiß, schwarz und grau. Die gewählten Endkappen für die Profile für Glasscheiben sind in einer transparenten Ausführung lieferbar, und die Endkappen für die Abdeckungen in einer opalen Ausführung. Der Kunststoff, der für die Produktion von den Endkappen verwendet wird erfüllt die Feuerbeständigkeitsnorm zur Beleuchtung Nummer: PN-EN 60695-2-11. Das Material: ABS, PC.

The endings, with the aim to aesthetically close the profile and additionally protect the LED source, come in four basic colours: silver, white, black and grey. The endings selected for the profiles for glass are available in transparent colour. Covers endings are available in opal colour. The material used for the production of the endings meets the lighting non-combustibility standard no.: PN-EN 60695-2-11. Material: ABS, PC.

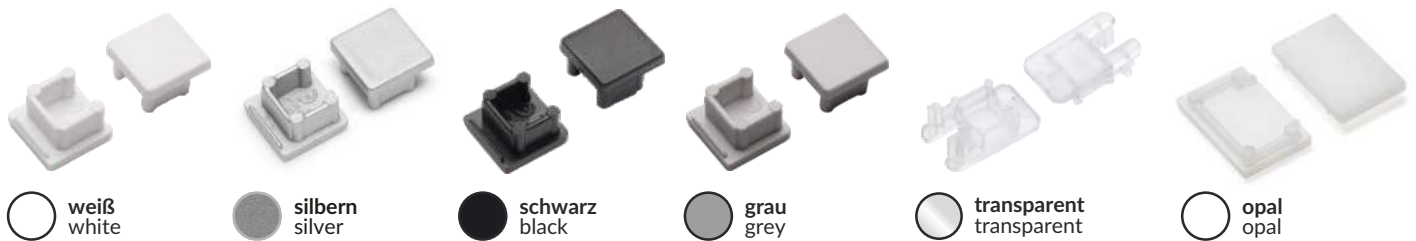

Die Endkappen mit oder ohne Öffnung - welche wählt man? Viele von unseren Endkappen sind in zwei Versionen lieferbar: Endings with a hole or without it - which one to choose? Some of our endings come in two versions:



Mit der Öffnung: ermöglichen ein ästhetisches Durchführen des Kabels ohne in der Endkappe oder in dem Profil bohren zu müssen.

With a hole: they allow aesthetic outlet for a cable without the need to drill through the ending or the profile.



Ohne Öffnung: bilden einen ästhetischen und dichteren Abschluss der Profile. Empfohlen dort, wo das Aussehen besonders wichtig ist oder zur Kabeldurchführung von der Rückseite.

Without a hole: they are an aesthetic and a tighter ending of the profile. Recommended in cases where the appearance is particularly significant, or from the opposite side to the cable outlet.

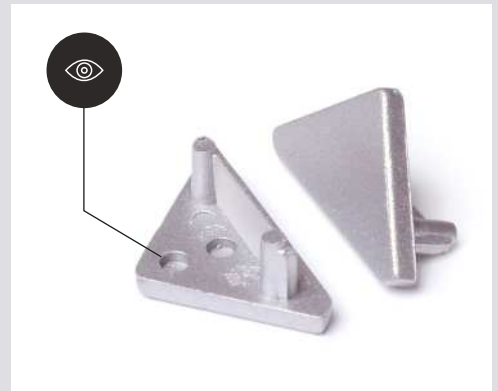

Für viele Profile bieten wir Endkappen mit Punkten für das Bohren einer Öffnung an. Mit dieser Lösung kann man aus einem Set von Endkappen jeweils eine Endkappe mit und ohne Öffnung einsetzen.

For many products, we offer endings with points to bore a hole. Thanks to this, from one set of endings, it is possible to obtain one ending of each type: with a hole and without one.

Bezeichnung / Oznaczenia

die Bezeichnung der Abdeckungen, die mit den Befestigungssockel in dem Profil passen
marking of covers fitting the sockets in the profile

A B C C1 C2 C3 D E E7 F G H I J K





die Bezeichnung der Halter, die zu dem Profil passen
marking of holders fitting the profile

S T U U4 U5 U6 U7 W X Y Z



Profile mit der Slick Funktion
profile with Slick socket



Typen der LED Profile
LED profile categories

-  Aufbauprofile
surface
-  Einbauprofile
recessed
-  Eckprofile
corner
-  spezielle Profile
special application
-  Glaskantenprofile
glass application

sonstige
others

-  maximale Breite des LED Streifens
maximum LED strip width
-  Achtung
note
-  Montageklebstoff
assembly adhesive
-  auf Lager verfügbar
available in stock
-  Hergestellt in Polen
made in Poland
-  EU Industriedesign
EU-registered industrial design

LED Zubehör / LED accessories

Für die LED Profile kann man unterschiedliche LED Lichtquellen und elektronische Komponenten anwenden. Sehr wichtig ist die richtige Reihenfolge der Verbindung der einzelnen Elemente.

Different LED sources and electronic components can be used for aluminium LED profiles. The correct sequence of connecting individual elements is very important.

Lichtquelle / Source



LED Kabel • Verbinder • Konnektoren
LED cable • connectors • distribution box



Schalter • Controller / Switch • controller



Netzteil 12 V oder 24 V
12 V or 24 V power supply

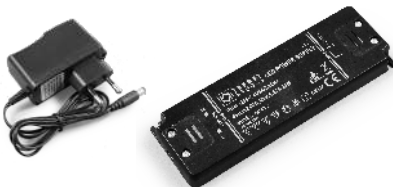

Kabel 220-240 V / 220-240 V cable

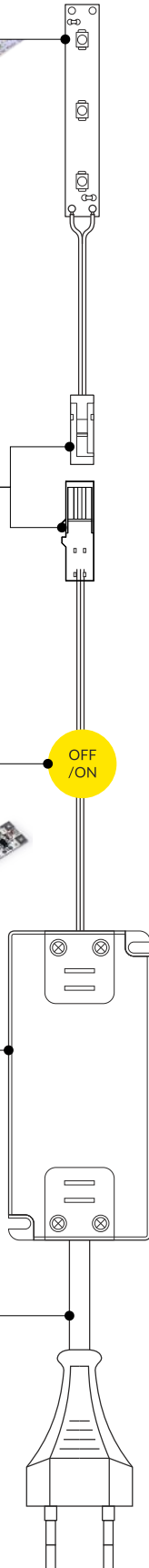

12 V

oder / or

24 V

220

-240V

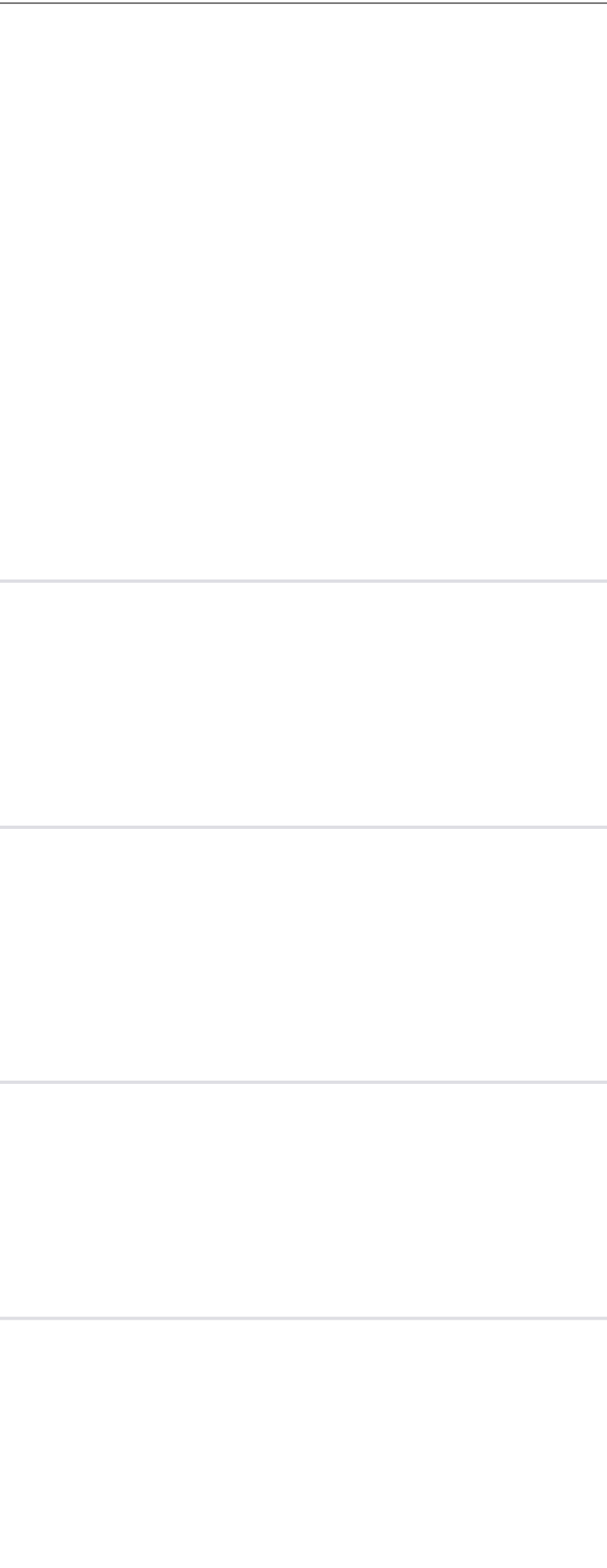

EIN KLEINES ALUMINIUMPROFIL FÜR AUFBAU

SMALL, ALUMINIUM, SURFACE PROFILE

- universelle Anwendung
 - Sockel mit Slick Funktion
 - zwei Rillen - zwei Niveaus der Befestigung des Halters (mit Abstand oder ohne Abstand von der Wand)
 - lackierte Halter
 - maximale Breite des LED Streifens 8 mm
-
- universal application
 - Slick socket
 - 2 channels for mounting bracket (with or without wall distance)
 - painted holders
 - maximum LED strip width: 8 mm

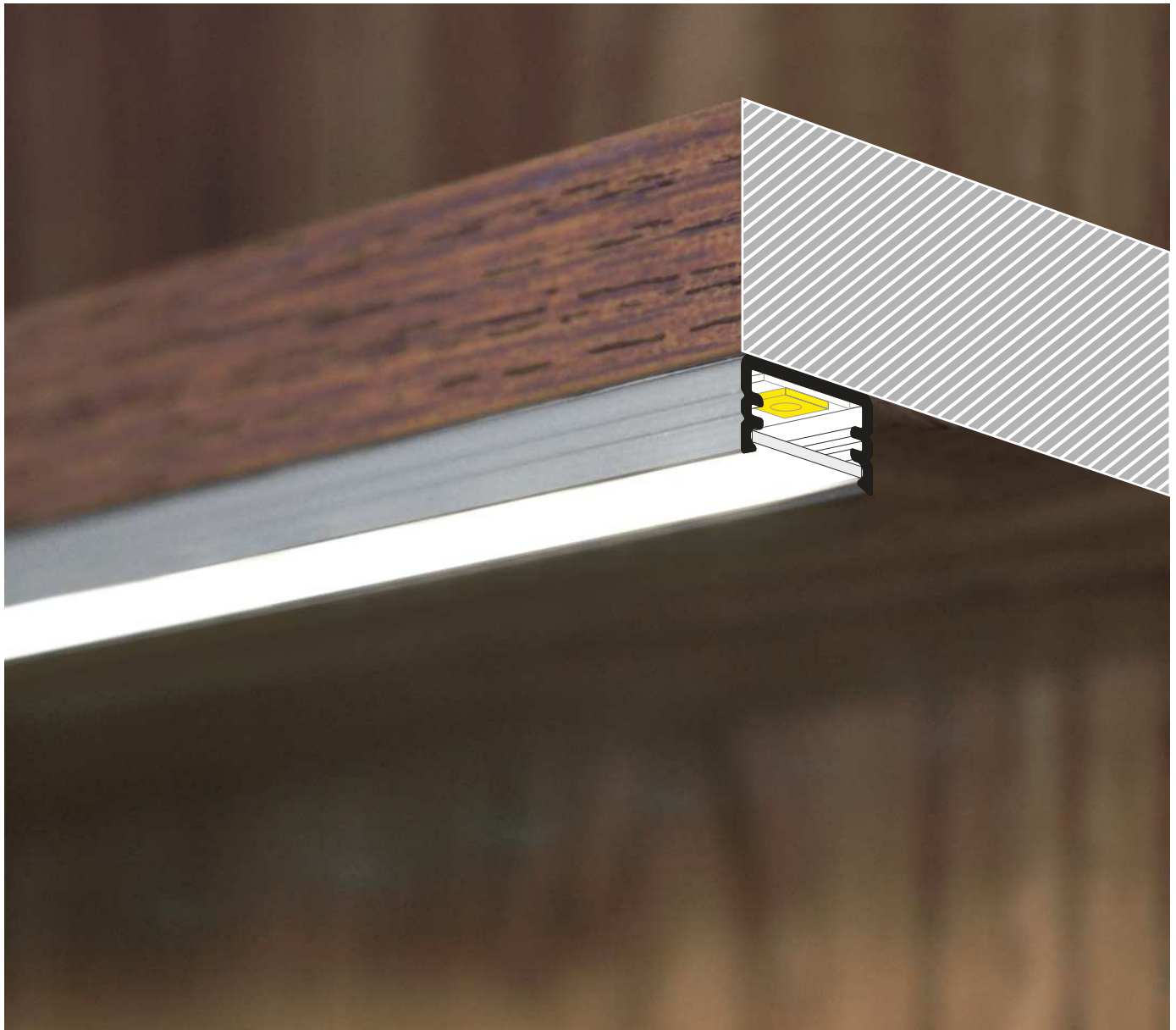

ÄHNLICHES IM ANGEBOT / SIMILAR IN THE OFFER



SMART10
AC2/Z



SURFACE10
BC/UX



BEGTON12
J/S



SURFACE14
EF/TY



A Abdeckung **A** einschiebbar
A slide cover

C2 Abdeckung **C2** einclippsbar
C2 click cover

Z¹ Halter **Z** flexibel
Z flexible mounting plate

Z² Halter **Z** flexibel cone
cone Z flexible mounting plate

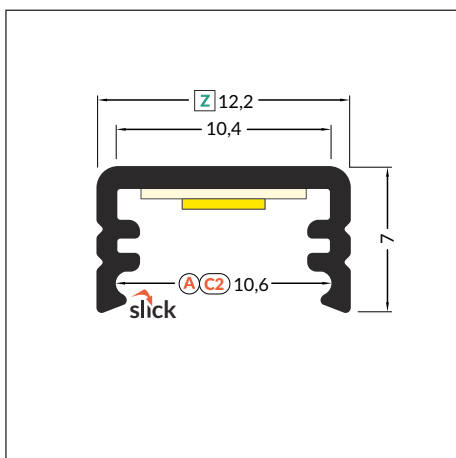
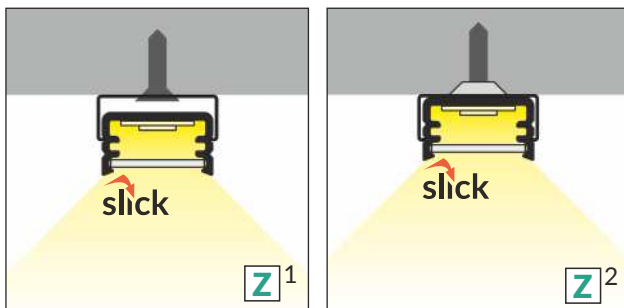
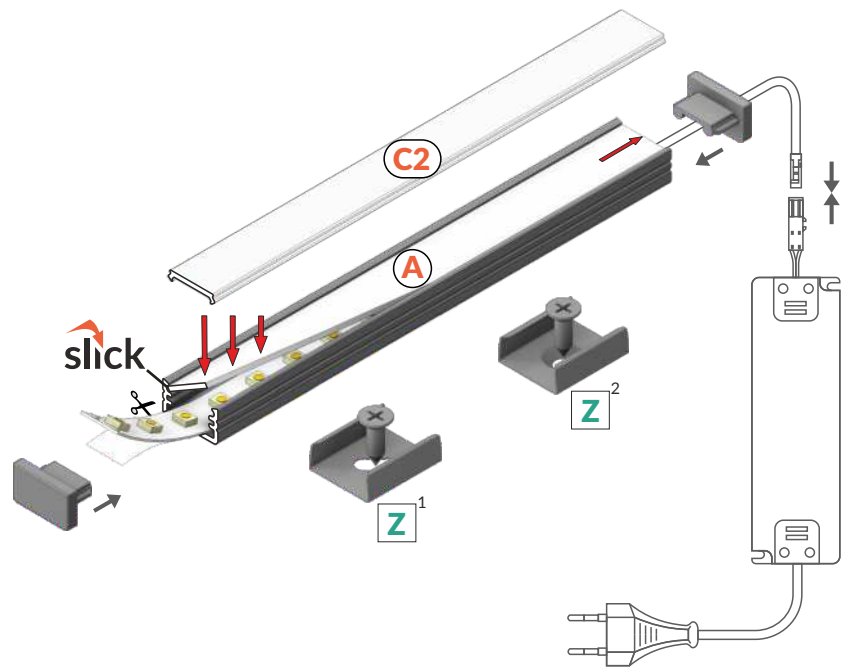

max 8 mm

Aufbauprofile
surface



Artikelnummer = 1 Stück, Länge 2.000 mm
INDEX = 1 pc, length 2000 mm

weiß lackiert
white painted
9589030001

eloxiert
anodized
9589030020

schwarz eloxiert
black anodized
9589030021

Rohaluminium
raw aluminium
9589030000

Die zugänglichen Längen: 1000 mm, 2000 mm, 3000 mm, 4000 mm.
Die standardmäßige Toleranz der Länge von Profilen beträgt: +20 mm.
Mehr Informationen >> 1.08.

Available lengths: 1000 mm, 2000 mm, 3000 mm, 4000 mm.
The standard profile length tolerance is +20 mm.
More details >> 1.08.



ABDECKUNG / COVERS

Abdeckung A einschiebbar
Farben: transparent, satiniert, opal
Material: PC, PP, PP

A slide cover
colours: transparent, frosted, opal
material: PC, PP, PP

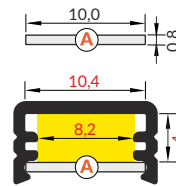

Achtung! Die Abmessungen des Platzes für die Montage von LED Lichtquelle
Note! Dimensions of the space to install LED source

Abdeckung C2 einclipsbar
Farben: transparent, opal
Material: PMMA



C2 click cover
colours: transparent, opal
material: PMMA

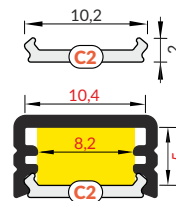

Länge 2.000 mm
length 2000 mm

A transparent
Artikelnummer = 10 Stück
index = 10 pcs
9589070016

A satiniert / A frosted
Artikelnummer = 10 Stück
index = 10 pcs
9589070039

A opal
Artikelnummer = 10 Stück
index = 10 pcs
9589070038

C2 transparent
Artikelnummer = 1 Stück
index = 1 pc
9589000216

C2 opal
Artikelnummer = 1 Stück
index = 1 pc
9589000238

Die Toleranz der Länge von Abdeckungen beträgt: +20 mm.
Mehr Informationen >> 1.08.
The standard cover length tolerance is +20 mm.
More details >> 1.08.

ENDKAPPEN / ENDINGS

Endkappe SLIM8
Farben: weiß, silbern, schwarz, grau
Material: ABS

SLIM8 ending
colours: white, silver, black, grey
material: ABS

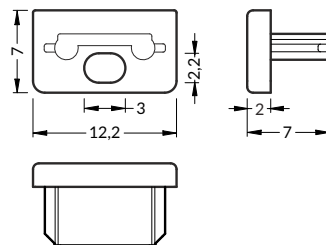

Endkappe SLIM8 mit Öffnung
Farben: weiß, silbern, schwarz, grau
Material: ABS

SLIM8 ending with hole
colours: white, silver, black, grey
material: ABS



Artikelnummer = 10 Sets = 20 Stück
INDEX = 10 sets = 20 pcs

weiß / white
9589080001
silbern / silver
9589080040
schwarz / black
9589080002
grau / grey
9589080022

weiß / white
9589140001
silbern / silver
9589140040
schwarz / black
9589140002
grau / grey
9589140022

HALTER / MOUNTINGS

Halter Z flexibel
Farben: weiß, inox, schwarz
Material: rostfreier Stahl

Z flexible mounting plate
colours: white, inox, black
material: stainless steel

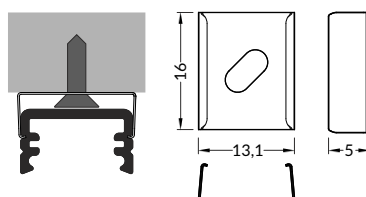

Artikelnummer = 10 Sets = 20 Stück
INDEX = 10 sets = 20 pcs

weiß / white
9589270001

inox
9589270019

schwarz / black
9589270002



HALTER / MOUNTINGS

Halter Z flexibel cone
Farben: weiß, inox, schwarz
Material: rostfreier Stahl

cone Z flexible mounting plate
colours: white, inox, black
material: stainless steel

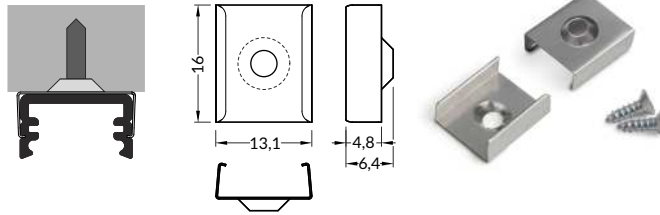

Artikelnummer = 10 Sets = 20 Stück
INDEX = 10 sets = 20 pcs

weiß / white
9589980001

inox
9589980019

schwarz / black
9589980002

Halter SLIM8 einfach
Material: verzinkter Stahl

SLIM8 simple holder
material: zinc coated steel

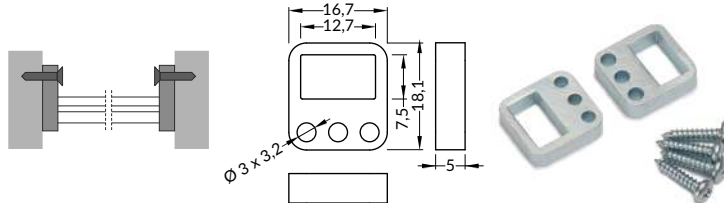

Artikelnummer = 1 Set = 2 Stück
INDEX = 1 set = 2 pcs

verzinkt
zinc coated
9589110030

VERBINDUNGSTÜCKE / CONNECTORS

Verbinder 90 Grad für SLIM8
Farben: weiß, eloxiert, schwarz
Material: Aluminium

SLIM8 connector 90 deg
colours: white, anodized, black
material: aluminium

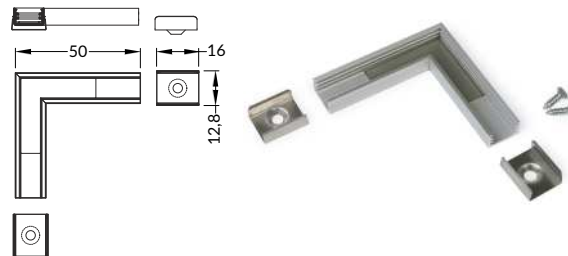

Artikelnummer = 1 Set
INDEX = 1 set

weiß lackiert
white painted
9589150001

eloxiert
anodized
9589150020

schwarz eloxiert
black anodized
9589150021

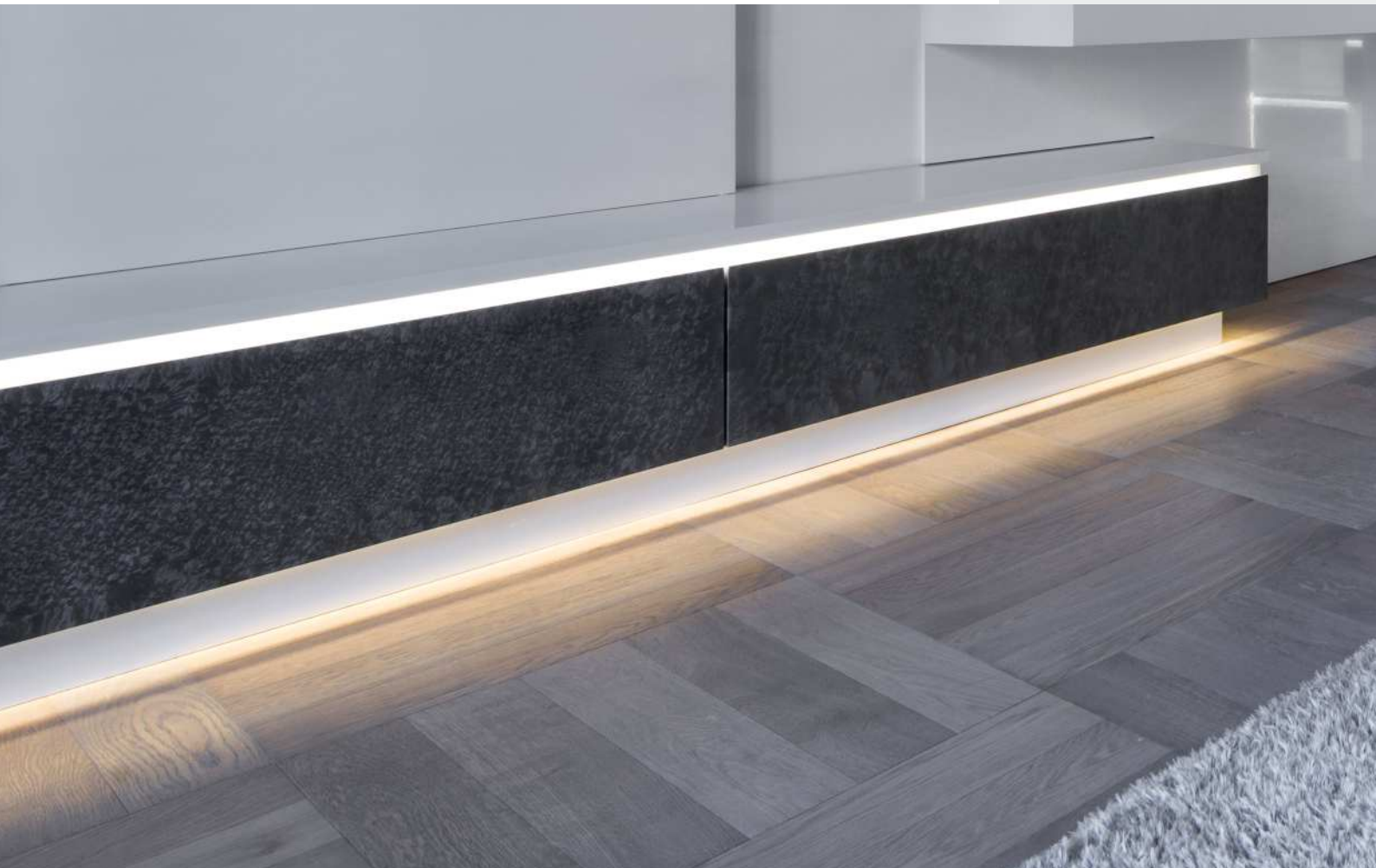

EINE HOMOGENE LICHTLINIE IN EINER KLEINEN GRÖßE

CONTINUOUS LINE OF LIGHT IN A SMALL OVERALL DIMENSIONS

- eine homogene Lichtlinie (bei LED Streifen mit 120 Leds/m und einer opalen Abdeckung)
 - Sockel mit Slick Funktion
 - kleine Maße
 - universelle Anwendung
 - die Möglichkeit der Anwendung von wasserdichten LED Streifen
 - maximale Breite des LED Streifens 10 mm
-
- continuous line of light (when using LED strip 120 P/m and opal cover)
 - SLICK socket
 - miniature dimensions
 - universal application
 - the possibility of using waterproof LED strips
 - maximum width of LED strip: 10 mm

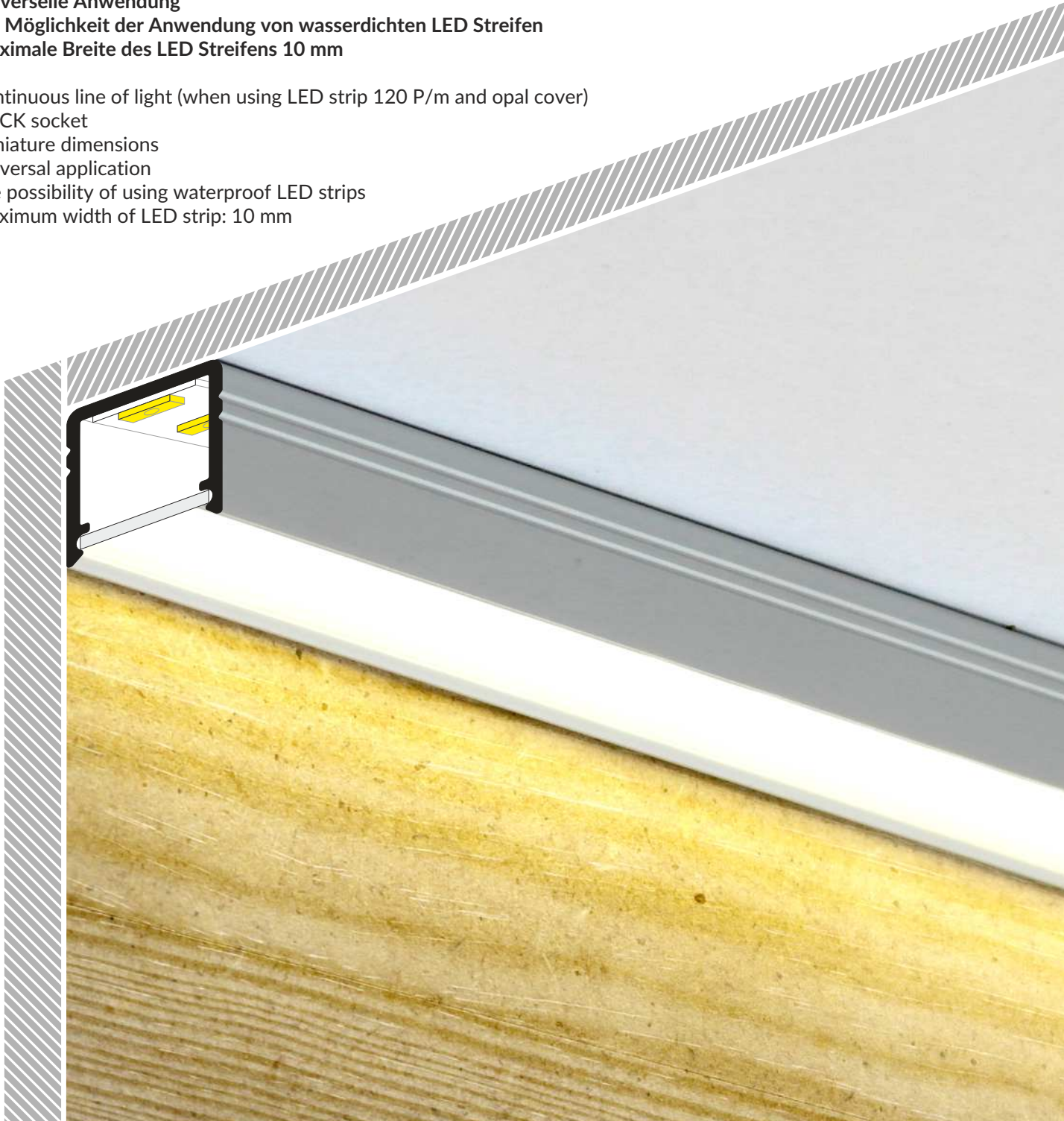

ÄHNLICHES IM ANGEBOT / SIMILAR IN THE OFFER



SLIM8
AC2/Z



SMART-IN10
AC2/Z



SURFACE10
BC/UX



BEGTON12
J/S



SURFACE14
EF/TY



A Abdeckung **A** einschiebbar
A slide cover

C2 Abdeckung **C2** einclipsbar
C2 click cover

Z¹ Halter **Z** flexibel
Z flexible mounting plate

Z² Halter **Z** flexibel cone
cone Z flexible mounting plate

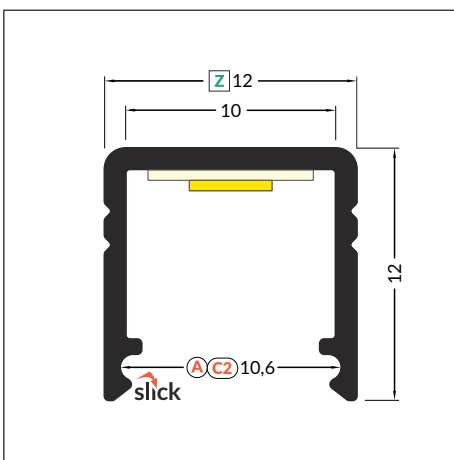
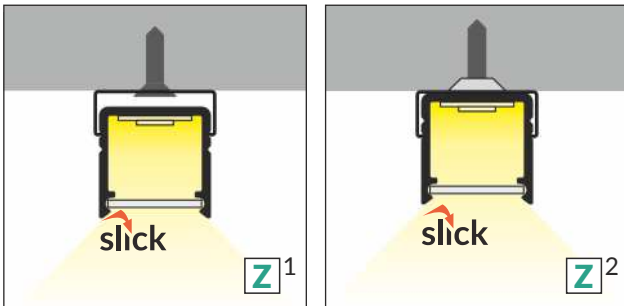
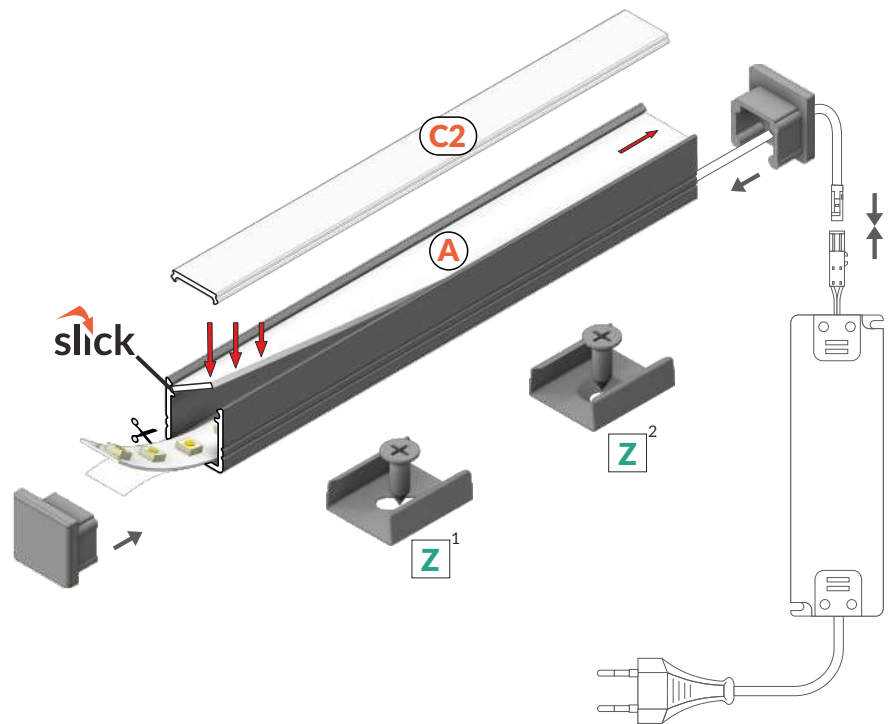

 max 10 mm

 Aufbauprofile
surface



Artikelnummer = 1 Stück, Länge 2.000 mm
INDEX = 1 pc, length 2000 mm

weiß lackiert
white painted
95C2020001

eloxiert
anodized
95C2020020

schwarz eloxiert
black anodized
95C2020021

Rohaluminium
raw aluminium
95C2020000

Die zugänglichen Längen: 1000 mm, 2000 mm, 3000 mm, 4000 mm.
Die standardmäßige Toleranz der Länge von Profilen beträgt: +20 mm.
Mehr Informationen >> 1.08.

Available lengths: 1000 mm, 2000 mm, 3000 mm, 4000 mm.
The standard profile length tolerance is +20 mm.
More details >> 1.08.



ABDECKUNG / COVERS

Abdeckung A einschiebbar
Farben: transparent, satiniert, opal
Material: PC, PP, PP

A slide cover
colours: transparent, frosted, opal
material: PC, PP, PP

Abdeckung C2 einclipsbar
Farben: transparent, opal
Material: PMMA



C2 click cover
colours: transparent, opal
material: PMMA

Achtung! Die Abmessungen des Platzes für die Montage von LED Lichtquelle
Note! Dimensions of the space to install LED source

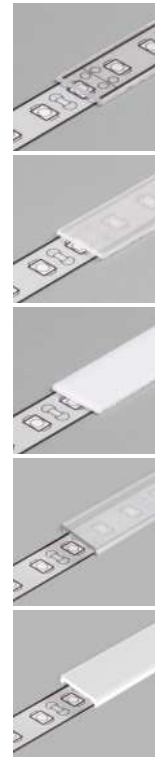
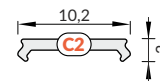
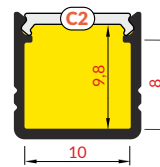
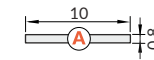
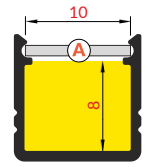

Länge 2.000 mm
length 2000 mm

A transparent
Artikelnummer = 10 Stück
index = 10 pcs
9589070016

A satiniert / A frosted
Artikelnummer = 10 Stück
index = 10 pcs
9589070039

A opal
Artikelnummer = 10 Stück
index = 10 pcs
9589070038

C2 transparent
Artikelnummer = 1 Stück
index = 1 pc
9589000216

C2 opal
Artikelnummer = 1 Stück
index = 1 pc
9589000238

Die Toleranz der Länge von Abdeckungen beträgt: +20 mm.
Mehr Informationen >> 1.08.
The standard cover length tolerance is +20 mm.
More details >> 1.08.

ENDKAPPEN / ENDINGS

Endkappe SMART10
Farben: weiß, silbern, schwarz, grau
Material: ABS

SMART10 ending
colours: white, silver, black, grey
material: ABS

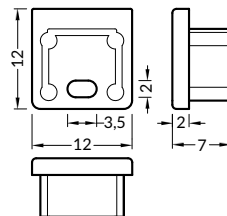

Endkappe SMART10 mit Öffnung
Farben: weiß, silbern, schwarz, grau
Material: ABS

SMART10 ending with hole
colours: white, silver, black, grey
material: ABS

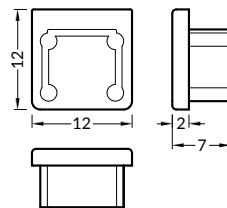

Artikelnummer = 10 Sets = 20 Stück
INDEX = 10 sets = 20 pcs

weiß / white
95C2940001
silbern / silver
95C2940040
schwarz / black
95C2940002
grau / grey
95C2940022

weiß / white
95C2960001
silbern / silver
95C2960040
schwarz / black
95C2960002
grau / grey
95C2960022

HALTER / MOUNTINGS

Halter Z flexibel
Farben: weiß, inox, schwarz
Material: rostfreier Stahl

Z flexible mounting plate
colours: white, inox, black
material: stainless steel

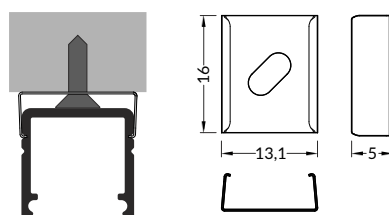

Artikelnummer = 10 Sets = 20 Stück
INDEX = 10 sets = 20 pcs

weiß / white
9589270001
inox
9589270019
schwarz / black
9589270002



HALTER / MOUNTINGS

Halter **Z** flexibel cone
Farben: weiß, inox, schwarz
Material: rostfreier Stahl

cone **Z** flexible mounting plate
colours: white, inox, black
material: stainless steel

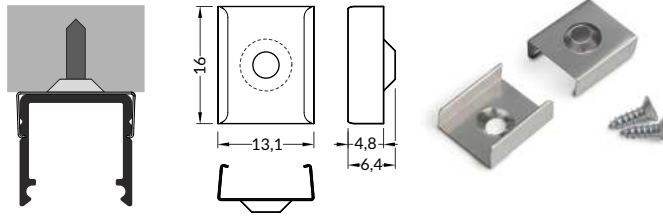

Artikelnummer = 10 Sets = 20 Stück
INDEX = 10 sets = 20 pcs

weiß / white
9589980001
inox
9589980019
schwarz / black
9589980002

VERBINDUNGSTÜCKE / CONNECTORS

Verbinder 90 Grad für SMART10
Farben: weiß, eloxiert, schwarz
Material: Aluminium

SMART10 connector 90 deg
colours: white, anodized, black
material: aluminium

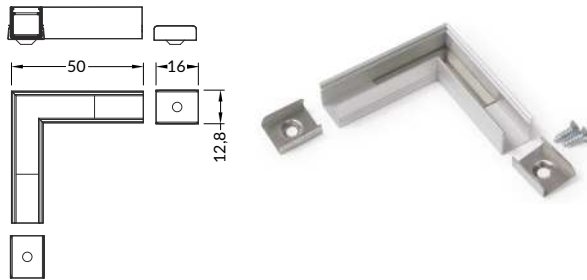

Artikelnummer = 1 Set
INDEX = 1 set

weiß lackiert
white painted
95C2910001

eloxiert
anodized
95C2910020

schwarz eloxiert
black anodized
95C2910021



SURFACE10 BC/UX

EIN ALUMINIUMPROFIL FÜR AUFBAU

ALUMINIUM SURFACE PROFILE

- eine versteckte Befestigung
- eine breite Zubehörwahl, 6 Arten der Abdeckungen
- maximale Breite des LED Streifens 10 mm

- hidden mounting
- wide range of accessories, 6 types of covers
- maximum LED strip width: 10 mm

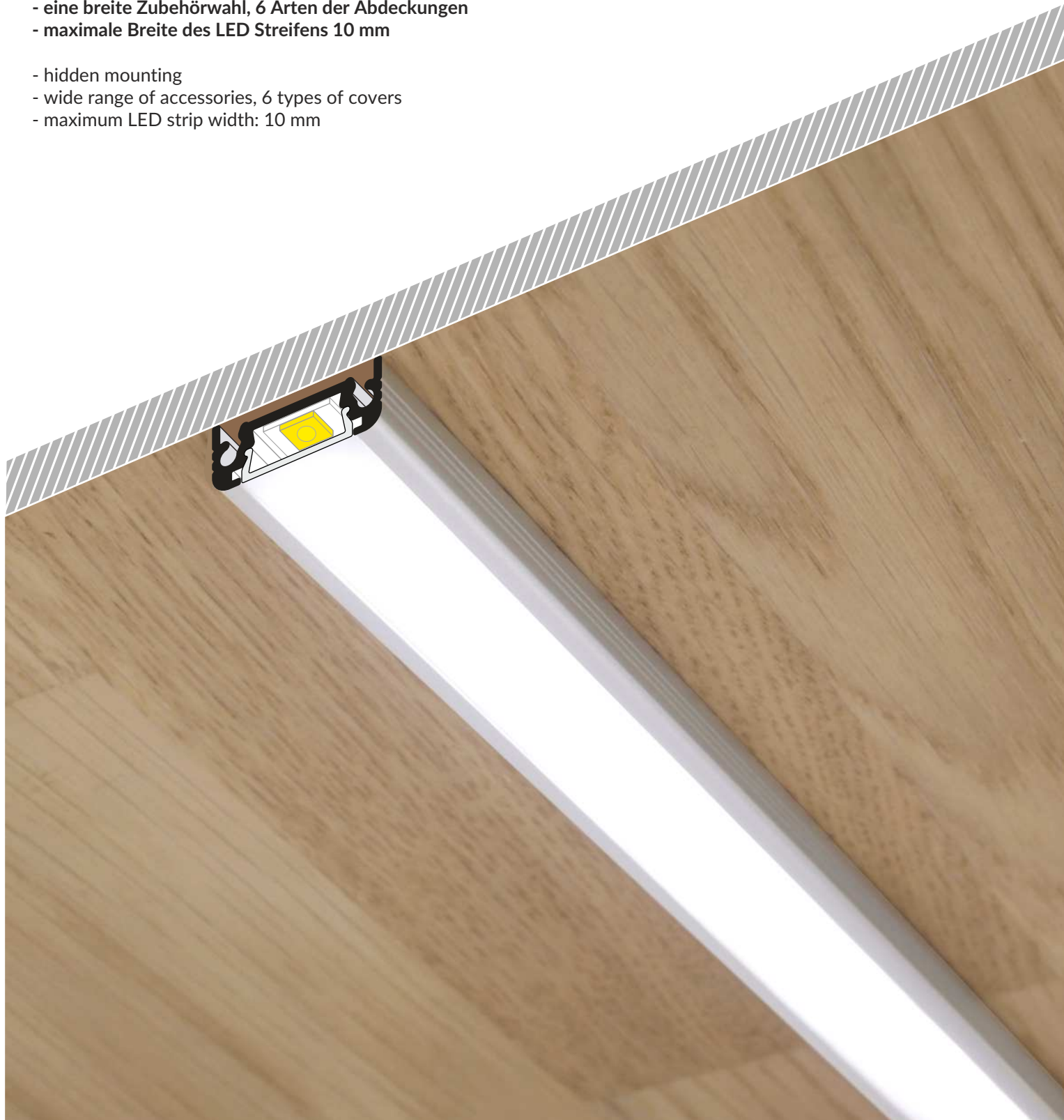

ÄHNLICHES IM ANGEBOT / SIMILAR IN THE OFFER

SLIM8
AC2/Z

SMART10
AC2/Z

BEGTON12
J/S

SURFACE14
EF/TY

LINEA20
EF/TY

WIDE24
G/W



- B** Abdeckung **B** einschiebbar
B slide cover
- C** Abdeckung **C** einclipsbar
C click cover
- C** Abdeckung **C** einclipsbar Linse
C lens cover
- U**¹ Halter **U** flexibel
U flexible mounting plate
- U**² Halter **U** flexibel cone
cone **U** flexible mounting plate
- X**¹ Halter **X**
X mounting plate

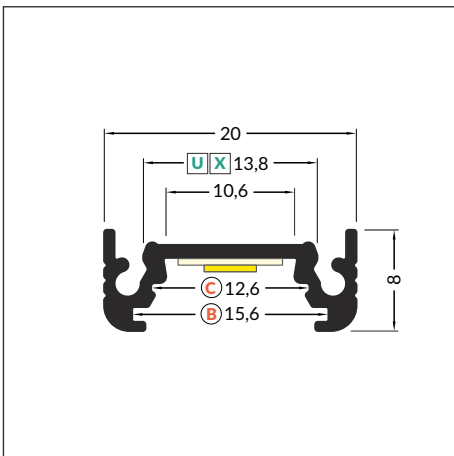
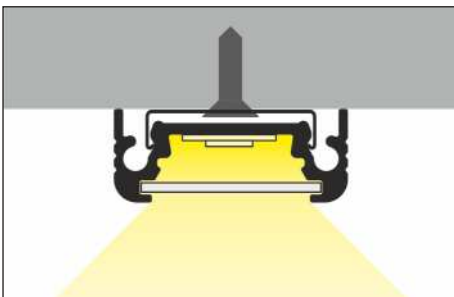
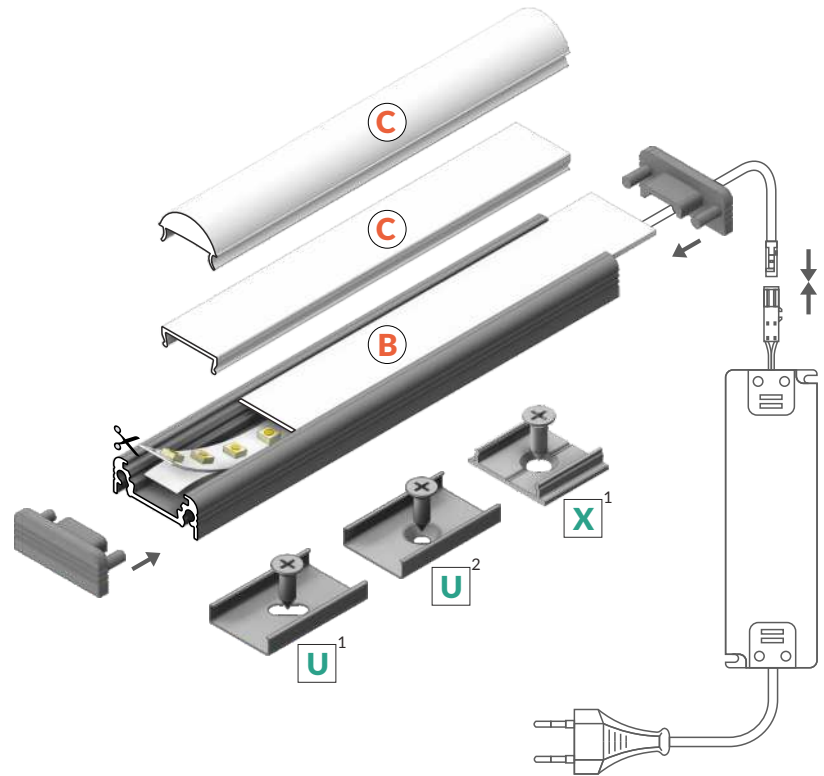

max 10 mm



Aufbauprofile
surface



Artikelnummer = 1 Stück, Länge 2.000 mm
INDEX = 1 pc, length 2000 mm

weiß lackiert
white painted
9577270001



eloxiert
anodized
9577270020



schwarz eloxiert
black anodized
9577270021



Rohaluminium
raw aluminium
9577270000

Die zugänglichen Längen: 1000 mm, 2000 mm, 3000 mm, 4000 mm.
Die standardmäßige Toleranz der Länge von Profilen beträgt: +20 mm.
Mehr Informationen >> 1.08.

Available lengths: 1000 mm, 2000 mm, 3000 mm, 4000 mm.
The standard profile length tolerance is +20 mm.
More details >> 1.08.



ABDECKUNG / COVERS

Abdeckung B einschiebbar
Farben: transparent, satiniert, opal
Material: PC, PP, PP

B slide cover
colours: transparent, frosted, opal
material: PC, PP, PP

Abdeckung C einclipbar
Farben: transparent, opal
Material: PMMA

C click cover
colours: transparent, opal
material: PMMA

Abdeckung C einclipbar Linse
Farben: transparent
Material: PC

C click cover lens
colour: transparent
material: PC



Achtung! Die Abmessungen des Platzes für die Montage von LED Lichtquelle
Note! Dimensions of the space to install LED source

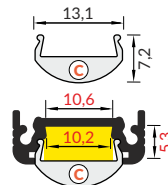
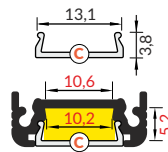
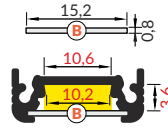

Länge 2.000 mm,
length 2000 mm

B transparent
Artikelnummer = 10 Stück
index = 10 pcs

9576250016



B satiniert / B frosted
Artikelnummer = 10 Stück
index = 10 pcs

9576250039



B opal
Artikelnummer = 10 Stück
index = 10 pcs

9576250038



C transparent
Artikelnummer = 1 Stück
index = 1 pc

9576330000



C opal
Artikelnummer = 1 Stück
index = 1 pc

9576330038



Rolle, Länge 20 m,
reel, length 20 m

C opal
Artikelnummer = 1 Stück
index = 1 pc

9576360038S



Länge 2.000 mm,
length 2000 mm

C Linse / C lens
Artikelnummer = 1 Stück
index = 1 pc

9576300000

NEU

Die Toleranz der Länge von Abdeckungen beträgt: +20 mm.
Mehr Informationen >> 1.08.

The standard cover length tolerance is +20 mm.
More details >> 1.08.

HALTER / MOUNTINGS

Halter U flexibel
Farben: inox
Material: rostfreier Stahl

U flexible mounting plate
colours: inox
material: stainless steel

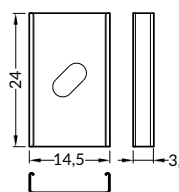
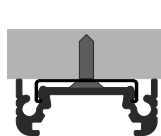

Artikelnummer = 10 Sets = 20 Stück
INDEX = 10 sets = 20 pcs

inox
9576380000

Halter U flexibel cone
Farben: inox
Material: rostfreier Stahl

cone **U** flexible mounting plate
colours: inox
material: stainless steel

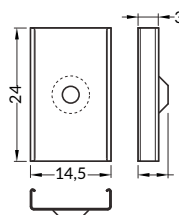
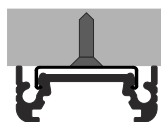

inox
9576620000

Halter X
Farben: Rohaluminium
Material: aluminium

X mounting plate
colours: raw aluminium
material: aluminium

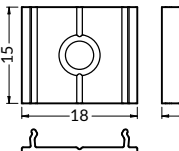
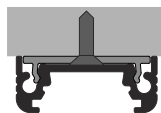

Rohaluminium
raw aluminium
9576260000



HALTER / MOUNTINGS

Halter SURFACE10 einfach
Material: verzinkter Stahl

SURFACE10 simple holder
material: zinc coated

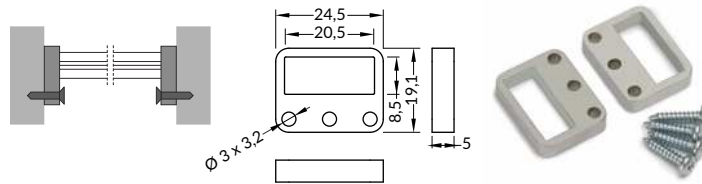

Artikelnummer = 1 Set = 2 Stück
INDEX = 1 set = 2 pcs

verzinkt / zinc coated
9577370030

ENDKAPPEN / ENDINGS

Endkappe SURFACE10 gen2
Farben: weiß, silbern, schwarz, grau
Material: ABS

SURFACE10 ending gen2
colours: white, silver, black, grey
material: ABS

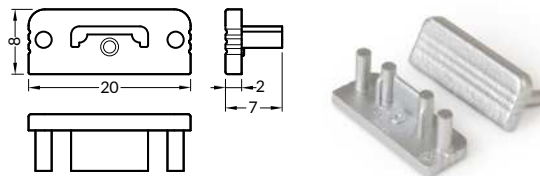

Artikelnummer = 10 Sets = 20 Stück
INDEX = 10 sets = 20 pcs

weiß / white
9577990001
silbern / silver
9577990040
schwarz / black
9577990002
grau / grey
9577990022

Endkappe SURFACE10 gen2 mit Öffnung
Farben: weiß, silbern, schwarz, grau
Material: ABS

SURFACE10 ending gen2 with hole
colours: white, silver, black, grey
material: ABS

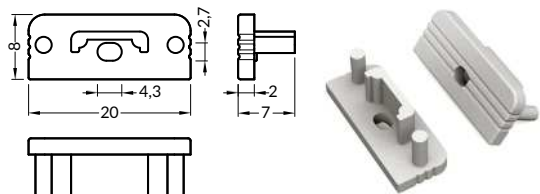

weiß / white
9577980001
silbern / silver
9577980040
schwarz / black
9577980002
grau / grey
9577980022

VERBINDUNGSTÜCKE / CONNECTORS

Verbindungsstück X 180 Grad
Farben: inox
Material: Aluminium

X connector 180 deg
colour: inox
material: aluminium

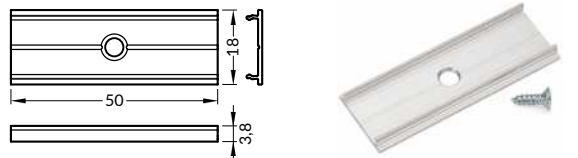

Artikelnummer = 1 Set
INDEX = 1 set

Rohaluminium
raw aluminium
9576350000

Verbinder 90 Grad für SURFACE10
Farben: weiß, eloxiert, schwarz
Material: Aluminium

SURFACE10 connector 90 deg
colours: white, anodized, black
material: aluminium

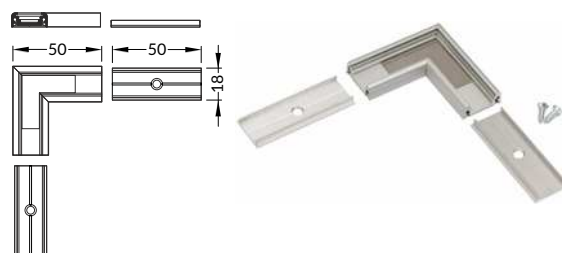

weiß lackiert
white painted
9577410001

eloxiert
anodized
9577410020

schwarz eloxiert
black anodized
9577410021



EIN KLEINES ALUMINIUMPROFIL FÜR AUFBAU

SMALL SURFACE ALUMINIUM PROFILE

- ein leichtes Budget-Profil
- Sockel mit Slick Funktion
- maximale Breite des LED Streifens 12 mm

- light weight, budget profile
- Slick socket
- maximum LED strip width: 12 mm



ÄHNLICHES IM ANGEBOT / SIMILAR IN THE OFFER



SLIM8
AC2/Z



SMART10
AC2/Z



SURFACE10
BC/UX



BEGTIN12
J/S



SURFACE14
EF/TY



J Abdeckung **J** einschiebbar
J slide cover

C Abdeckung **C** einclippsbar
C click cover

C* die Endkappe Begton12 **C** für die Abdeckung **C** einclippsbar
BEGTON12 C ending for C click cover

S¹ Halter **S** flexibel
S flexible mounting plate

S² Halter **S** flexibel cone
cone S flexible mounting plate

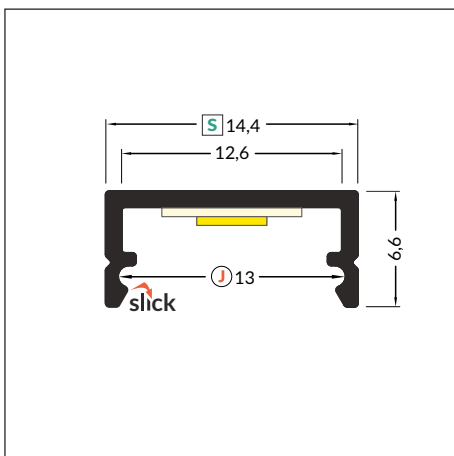
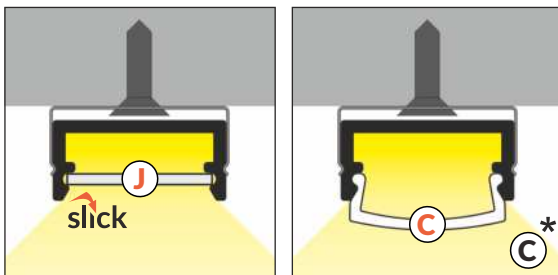
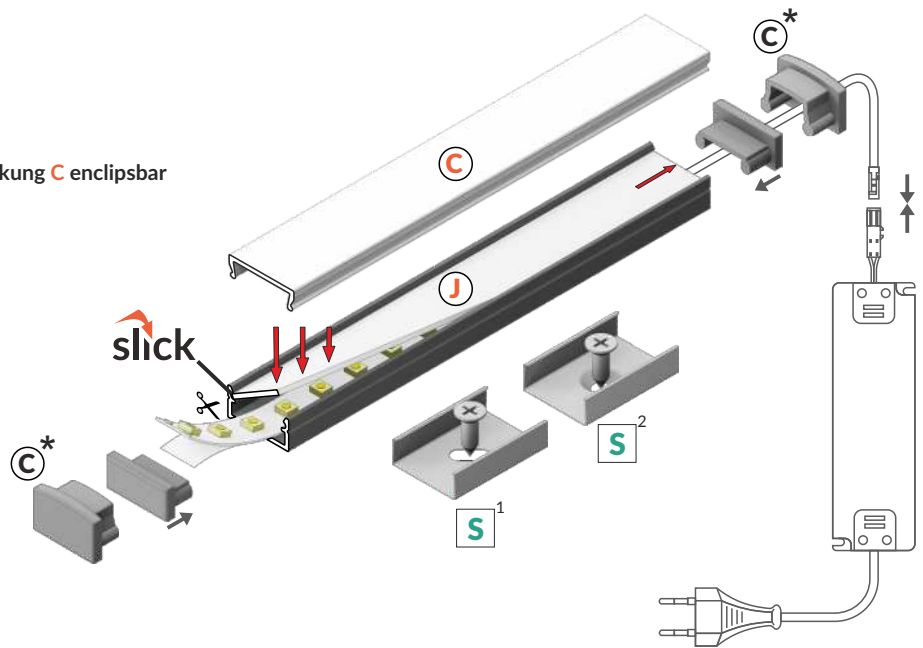

max 12 mm

Aufbauprofile
surface



Artikelnummer = 1 Stück, Länge 2.000 mm
INDEX = 1 pc, length 2000 mm

weiß lackiert
white painted
95C7020001



eloxiert
anodized
95C7020020



schwarz eloxiert
black anodized
95C7020021



Rohaluminium
raw aluminium
95C7020000

Die zugänglichen Längen: 1000 mm, 2000 mm, 3000 mm, 4000 mm.
Die standardmäßige Toleranz der Länge von Profilen beträgt: +20 mm.
Mehr Informationen >> 1.08.

Available lengths: 1000 mm, 2000 mm, 3000 mm, 4000 mm.
The standard profile length tolerance is +20 mm.
More details >> 1.08.



ABDECKUNG / COVERS

Abdeckung **J** einschiebbar
Farben: transparent, satiniert, opal
Material: PC, PP, PP

J slide cover
colours: transparent, frosted, opal
material: PC, PP, PP



Achtung! Die Abmessungen des Platzes für die Montage von LED Lichtquelle
Note! Dimensions of the space to install LED source

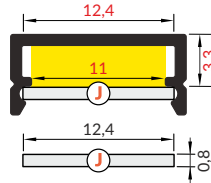

Länge 2.000 mm,
length 2000 mm

J transparent
Artikelnummer = 10 Stück
index = 10 pcs
9570330016

J satiniert / **J** frosted
Artikelnummer = 10 Stück
index = 10 pcs
9570330039

J opal
Artikelnummer = 10 Stück
index = 10 pcs
9570330038

Die Toleranz der Länge von Abdeckungen beträgt: +20 mm.
Mehr Informationen >> 1.08.
The standard cover length tolerance is +20 mm.
More details >> 1.08.

ENDKAPPEN / ENDINGS

Endkappe **BEGTON12**
Farben: weiß, silbern, schwarz, grau
Material: ABS
BEGTON12 ending
colours: white, silver, black, grey
material: ABS

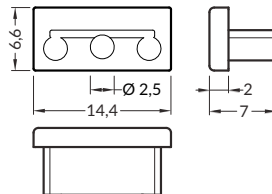

Die Endkappe mit Punkten für das Bohren von Öffnungen.
Ending with marked space to bore the holes.

Endkappe **BEGTON12 C**
Farben: weiß, silbern, schwarz, grau
Material: ABS
BEGTON12 C ending
colours: white, silver, black, grey
material: ABS

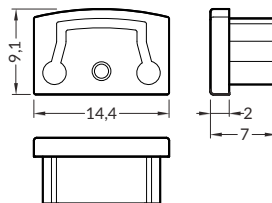

Artikelnummer = 10 Sets = 20 Stück
INDEX = 10 sets = 20 pcs

weiß / white
95C7960001
silbern / silver
95C7960040
schwarz / black
95C7960002
grau / grey
95C7960022

weiß / white
95C7940001
silbern / silver
95C7940040
schwarz / black
95C7940002
grau / grey
95C7940022

HALTER / MOUNTINGS

Halter **S** flexibel
Farben: weiß, inox, schwarz
Material: rostfreier Stahl
S flexible mounting plate
colours: white, inox, black
material: stainless steel

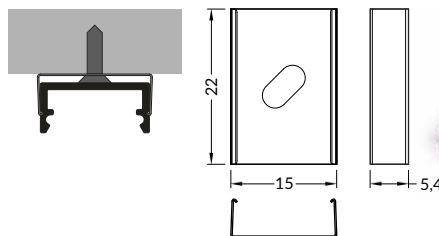

Artikelnummer = 10 Sets = 20 Stück
INDEX = 10 sets = 20 pcs

weiß / white
95C7980001
inox
95C7980019
schwarz / black
95C7980002

Halter **S** flexibel cone
Farben: weiß, inox, schwarz
Material: rostfreier Stahl
cone **S** flexible mounting plate
colours: white, inox, black
material: stainless steel

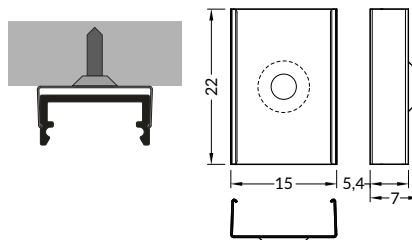

weiß / white
95C7950001
inox
95C7950019
schwarz / black
95C7950002



UNI12 BCD/U

EIN EINBAU-AUFBAUPROFIL

SURFACE AND RECESSED PROFILE

- 7 Abdeckungen zur Wahl
- erhöhte Radiation – die Möglichkeit der Anwendung eines stärkeren LED Streifens
- maximale Breite des LED Streifens 12 mm

- 7 diffusers to choose from
- increased radiation – it is possible to use a stronger LED strip
- maximum LED strip width: 12 mm



ÄHNLICHES IM ANGEBOT / SIMILAR IN THE OFFER



DEEP10
BC/UX



GROOVE10
BC/UX



SURFACE10
BC/UX



FLOOR12
K/U



UNI-TILE12
90 deg C



UNI-TILE12
180 deg C



UNI-TILE12
270 deg C



- B** Abdeckung **B** einschiebbar
B slide cover
- C** Abdeckung **C** einclipsbar
C click cover
- C** Abdeckung **C** einclipsbar Linse
C lens cover
- D** Abdeckung **D** einclipsbar
D click cover
- U**¹ Halter **U** flexibel
U flexible mounting plate
- U**² Halter **U** flexibel cone
cone U flexible mounting plate

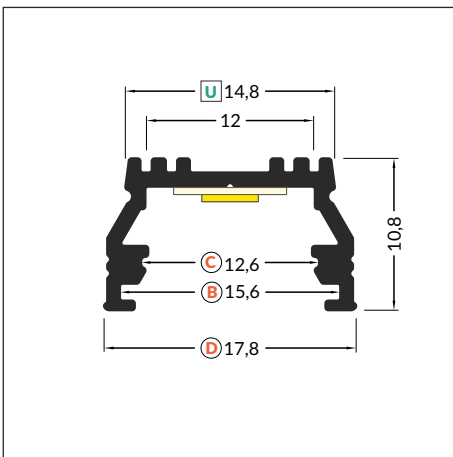
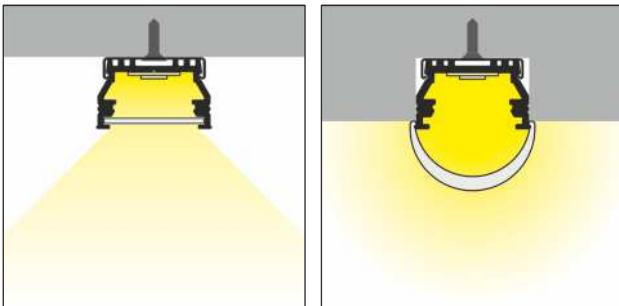
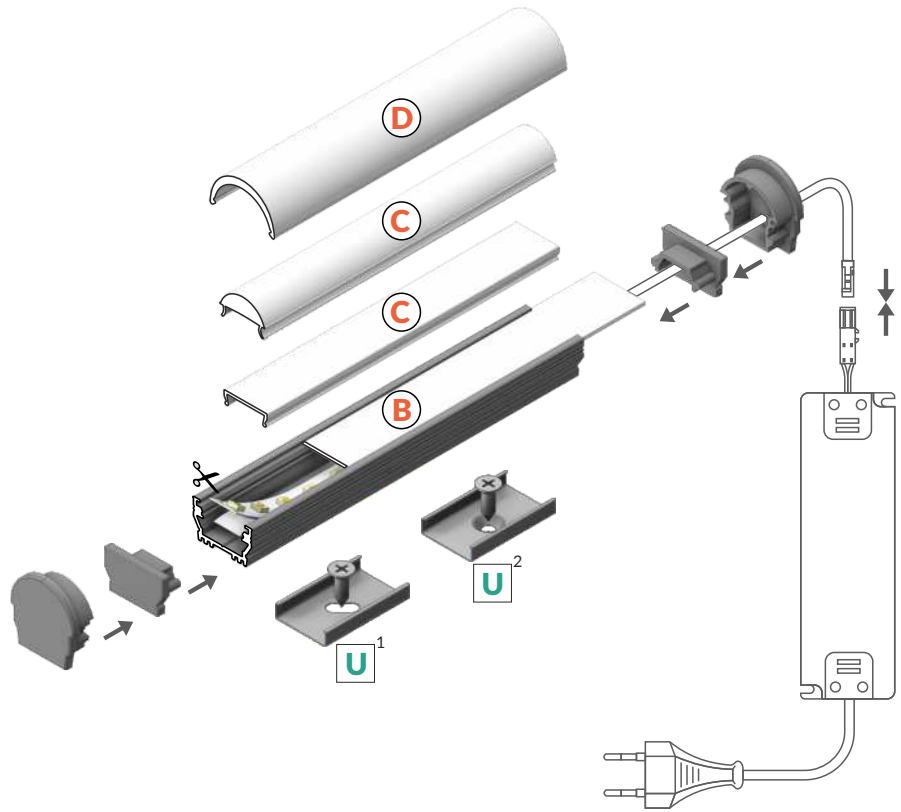

 max 12 mm

 Aufbauprofile
surface

 Einbauprofile
recessed



Artikelnummer = 1 Stück, Länge 2.000 mm
INDEX = 1 pc, length 2000 mm

weiß lackiert
white painted
95A1020001

eloxiert
anodized
95A1020020

schwarz eloxiert
black anodized
95A1020021

Rohaluminium
raw aluminium
95A1020000

Die zugänglichen Längen: 1000 mm, 2000 mm, 3000 mm, 4000 mm.
Die standardmäßige Toleranz der Länge von Profilen beträgt: +20 mm.
Mehr Informationen >> 1.08.

Available lengths: 1000 mm, 2000 mm, 3000 mm, 4000 mm.
The standard profile length tolerance is +20 mm.
More details >> 1.08.



ABDECKUNG / COVERS

Abdeckung **B** einschiebbar

Farben: transparent, satiniert, opal
Material: PC, PP, PP

B slide cover

colours: transparent, frosted, opal
material: PC, PP, PP



Achtung! Die Abmessungen des Platzes für die Montage von LED Lichtquelle
Note! Dimensions of the space to install LED source

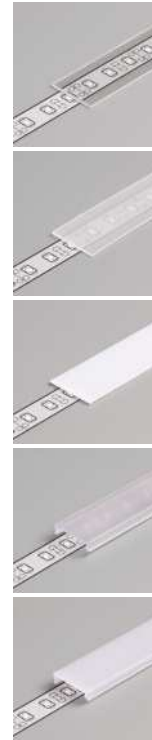
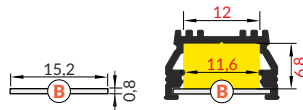

Länge 2.000 mm,
length 2000 mm

B transparent

Artikelnummer = 10 Stück
index = 10 pcs

9576250016

B satiniert / **B** frosted

Artikelnummer = 10 Stück
index = 10 pcs

9576250039

B opal

Artikelnummer = 10 Stück
index = 10 pcs

9576250038

Abdeckung **C** einclipsbar

Farben: transparent, opal
Material: PMMA

C click cover

colours: transparent, opal
material: PMMA

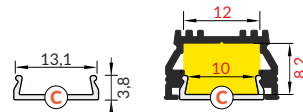

C transparent

Artikelnummer = 1 Stück
index = 1 pc

9576330000

C opal

Artikelnummer = 1 Stück
index = 1 pc

9576330038



Abdeckung **C** einclipsbar Linse

Farben: transparent
Material: PC

C click cover lens

colour: transparent
material: PC

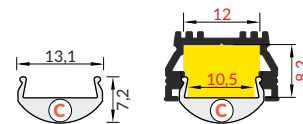

Rolle, Länge 20 m,
reel, length 20 m

C opal

Artikelnummer = 1 Stück
index = 1 pc

9576360038S

Abdeckung **D** einclipsbar

Farben: opal
Material: PMMA

D click cover

colours: opal
material: PMMA

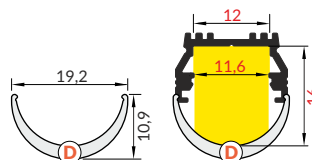

Länge 2.000 mm,
length 2000 mm

C Linse / **C** lens

Artikelnummer = 1 Stück
index = 1 pc

9576300000

D opal

Artikelnummer = 1 Stück
index = 1 pc

95A1140038

Die Toleranz der Länge von Abdeckungen beträgt: +20 mm.
Mehr Informationen >> 1.08.

The standard cover length tolerance is +20 mm.
More details >> 1.08.

HALTER / MOUNTINGS

Halter **U** flexibel

Farben: inox
Material: rostfreier Stahl

U flexible mounting plate

colour: inox
material: stainless steel

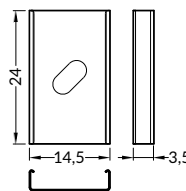
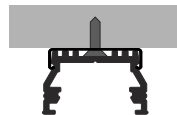

Artikelnummer = 10 Sets = 20 Stück
INDEX = 10 sets = 20 pcs

inox

9576380000

Halter **U** flexibel cone

Farben: inox
Material: rostfreier Stahl

cone **U** flexible mounting plate

colour: inox
material: stainless steel

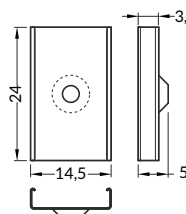
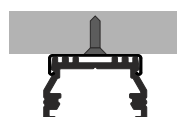

inox

9576620000



VERBINDUNGSTÜCKE / CONNECTORS

Verbinder 90 Grad für UNI12
Farben: weiß, eloxiert, schwarz
Material: Aluminium

UNI12 connector 90 deg
colours: white, anodized, black
material: aluminium

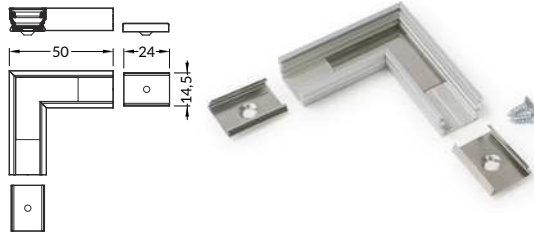

Artikelnummer = 1 Set
INDEX = 1 set

weiß lackiert
white painted
95A1910001

eloxiert
anodized
95A1910020

schwarz eloxiert
black anodized
95A1910021

ENDKAPPEN / ENDINGS

Endkappe UNI12 gen2
Farben: weiß, silbern, schwarz, grau
Material: ABS

UNI12 ending gen2
colours: white, silver, black, grey
material: ABS

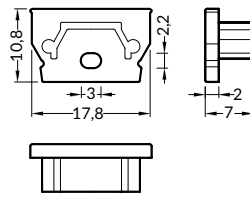

weiß / white
95A1900001
silbern / silver
95A1900040
schwarz / black
95A1900002
grau / grey
95A1900022

Endkappe UNI12 gen2 mit Öffnung
Farben: weiß, silbern, schwarz, grau
Material: ABS

UNI12 ending gen2 with hole
colours: white, silver, black, grey
material: ABS



weiß / white
95A1890001
silbern / silver
95A1890040
schwarz / black
95A1890002
grau / grey
95A1890022

Endkappe UNI12 D
Farben: weiß, silbern, schwarz, grau
Material: ABS

UNI12 D ending
colours: white, silver, black, grey
material: ABS

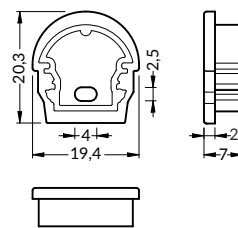

weiß / white
95A1940001
silbern / silver
95A1940040
schwarz / black
95A1940002
grau / grey
95A1940022

Endkappe UNI12 D mit Öffnung
Farben: weiß, silbern, schwarz, grau
Material: ABS

UNI12 D ending with hole
colours: white, silver, black, grey
material: ABS



weiß / white
95A1960001
silbern / silver
95A1960040
schwarz / black
95A1960002
grau / grey
95A1960022



SURFACE14 EF/TY

EIN ALUMINIUMPROFIL FÜR AUFBAU

ALUMINIUM SURFACE PROFILE

- eine versteckte Befestigung
- maximale Breite des LED Streifens 14 mm
- hidden mounting
- maximum LED strip width: 14 mm

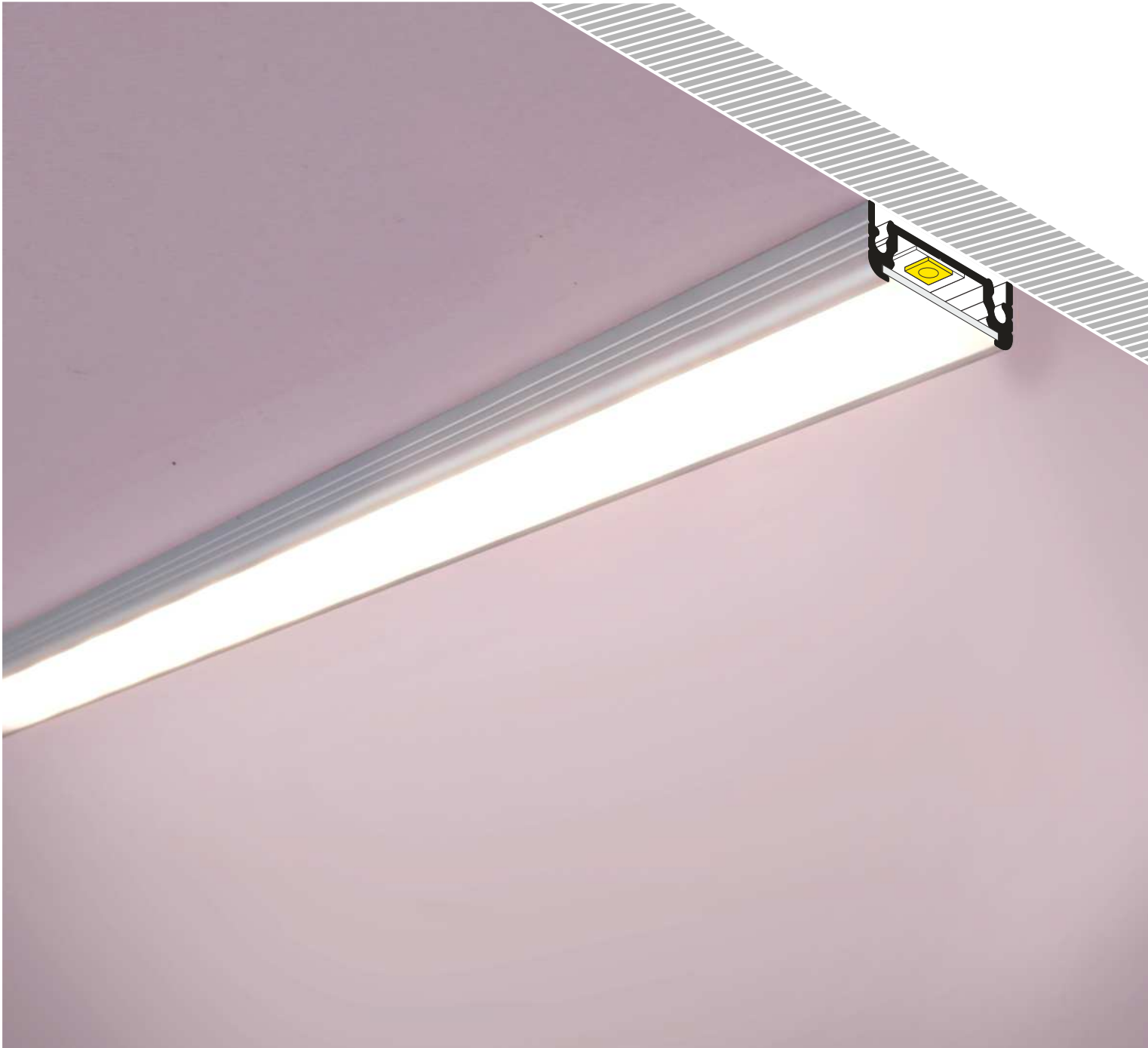

ÄHNLICHES IM ANGEBOT / SIMILAR IN THE OFFER

SLIM8
AC2/Z

SMART10
AC2/Z

SURFACE10
BC/UX

LINEA20
EF/TY

WIDE24
G/W



E Abdeckung **E** einschiebbar
E slide cover

F Abdeckung **F** einclipsbar
F click cover

E7 Abdeckung **E7** einclipsbar
E7 click cover

Y¹ Halter **Y** flexibel
Y flexible mounting plate

Y² Halter **Y** flexibel cone
cone Y flexible mounting plate

T Halter **T**
T mounting plate

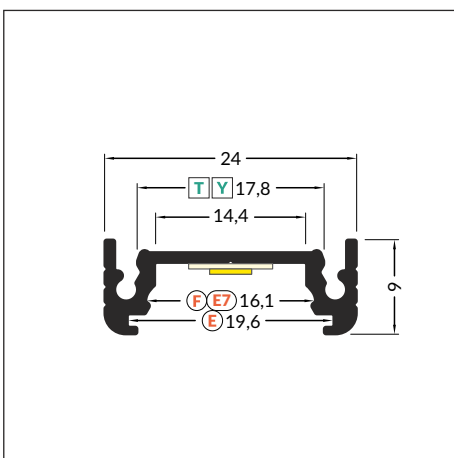
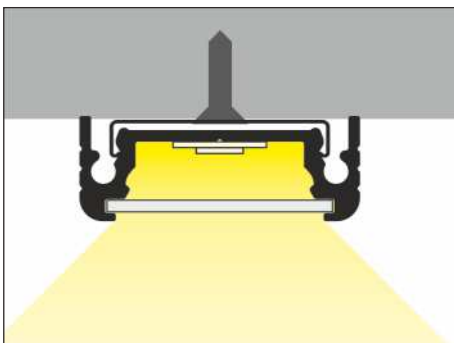
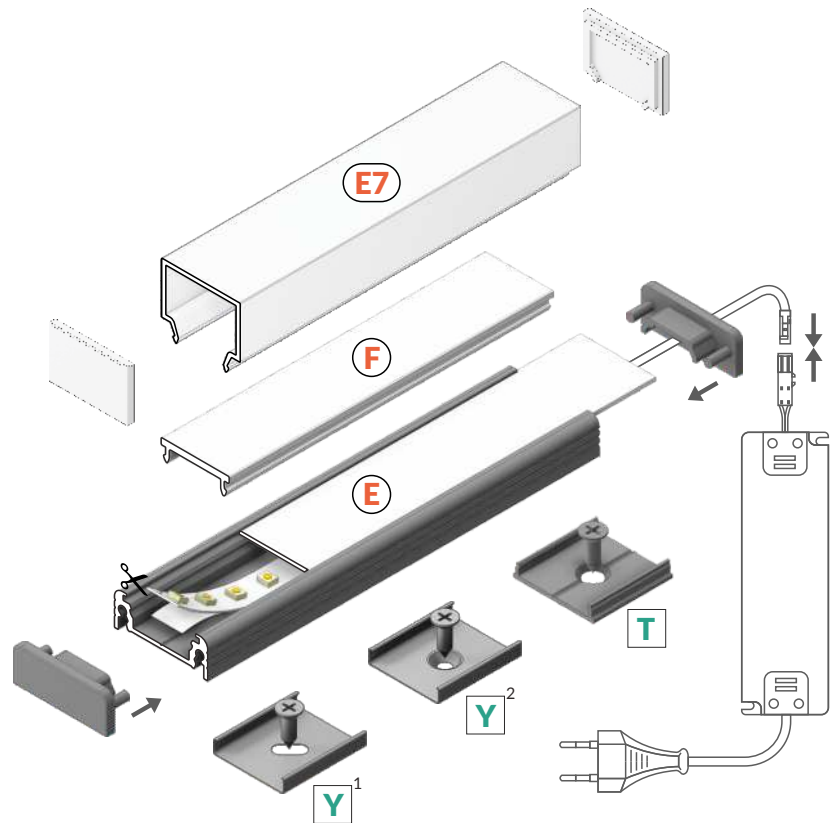

 max 14 mm

 Aufbauprofile
surface



Artikelnummer = 1 Stück, Länge 2.000 mm
INDEX = 1 pc, length 2000 mm

weiß lackiert
white painted
95A2020001



eloxiert
anodized
95A2020020



schwarz eloxiert
black anodized
95A2020021



Rohaluminium
raw aluminium
95A2020000

Die zugänglichen Längen: 1000 mm, 2000 mm, 3000 mm, 4000 mm.
Die standardmäßige Toleranz der Länge von Profilen beträgt: +20 mm.
Mehr Informationen >> 1.08.

Available lengths: 1000 mm, 2000 mm, 3000 mm, 4000 mm.
The standard profile length tolerance is +20 mm.
More details >> 1.08.



ABDECKUNG / COVERS

Abdeckung E einziehbar
Farben: transparent, satiniert, opal
Material: PC, PP, PP

E slide cover
colours: transparent, frosted, opal
material: PC, PP, PP

Abdeckung F einclipsbar
Farben: transparent, opal
Material: PMMA

F click cover
colours: transparent, opal
material: PMMA

Abdeckung E7 einclipsbar
Farben: opal
Material: PMMA

E7 click cover
colour: opal
material: PMMA



Achtung! Die Abmessungen des Platzes für die Montage von LED Lichtquelle
Note! Dimensions of the space to install LED source

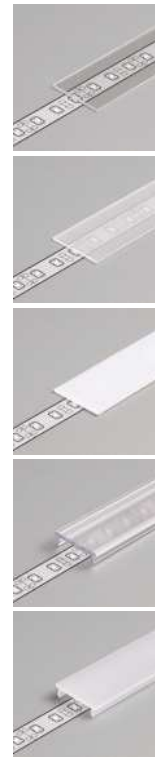
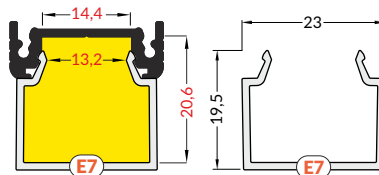
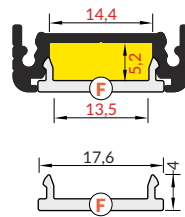
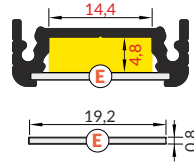

Länge 2.000 mm,
length 2000 mm

E transparent
Artikelnummer = 10 Stück
index = 10 pcs
95A2040016

E satiniert / E frosted
Artikelnummer = 10 Stück
index = 10 pcs
95A2040039

E opal
Artikelnummer = 10 Stück
index = 10 pcs
95A2040038

F transparent
Artikelnummer = 1 Stück
index = 1 pc
95A2060016

F opal
Artikelnummer = 1 Stück
index = 1 pc
95A2060038

Rolle, Länge 20 m,
reel, length 20 m

F opal
Artikelnummer = 1 Stück
index = 1 pc
95A2210038S

Länge 2.000 mm,
length 2000 mm

E7 opal
Artikelnummer = 1 Stück
index = 1 pc
95C1080038

NEU



Die Toleranz der Länge von Abdeckungen beträgt: +20 mm.
Mehr Informationen >> 1.08.
The standard cover length tolerance is +20 mm.
More details >> 1.08.

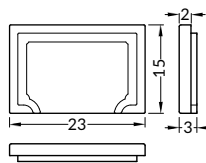

Artikelnummer = 1 Set = 2 Stück
INDEX = 1 set = 2 pcs

Endkappe **E7** opal
E7 opal ending
95C1840038

HALTER / MOUNTINGS

Halter Y flexibel
Farben: inox
Material: rostfreier Stahl
Y flexible mounting plate
colour: inox
material: stainless steel

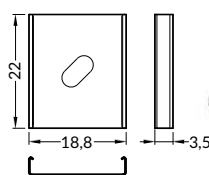
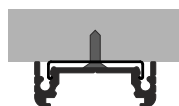

Artikelnummer = 10 Sets = 20 Stück
INDEX = 10 sets = 20 pcs

inox
95A2090019

Halter Y flexibel cone
Farben: inox
Material: rostfreier Stahl
cone **Y** flexible mounting plate
colour: inox
material: stainless steel

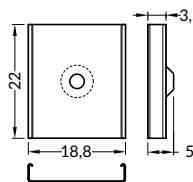
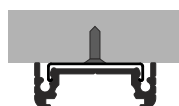

inox
95A2130019



Halter T
Farben: Rohaluminium
Material: Aluminium

T mounting plate
colour: raw aluminium
material: aluminium

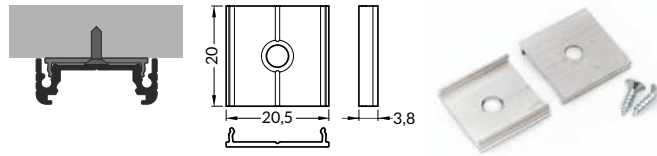

Artikelnummer = 10 Sets = 20 Stück
INDEX = 10 sets = 20 pcs

Rohaluminium
raw aluminium
95C6960000

ENDKAPPEN / ENDINGS

Endkappe SURFACE14 gen2
Farben: weiß, silbern, schwarz, grau
Material: ABS

SURFACE14 ending gen2
colours: white, silver, black, grey
material: ABS

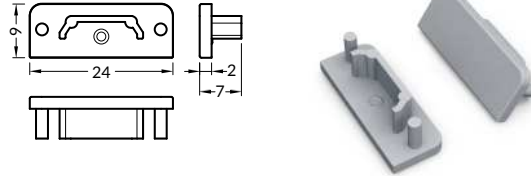

Artikelnummer = 10 Sets = 20 Stück
INDEX = 10 sets = 20 pcs

weiß / white
95A2980001
silbern / silver
95A2980040
schwarz / black
95A2980002
grau / grey
95A2980022

Endkappe SURFACE14 gen2 mit Öffnung
Farben: weiß, silbern, schwarz, grau
Material: ABS

SURFACE14 ending gen2 with hole
colours: white, silver, black, grey
material: ABS

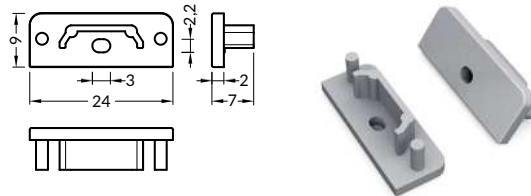

weiß / white
95A2970001
silbern / silver
95A2970040
schwarz / black
95A2970002
grau / grey
95A2970022

VERBINDUNGSSTÜCKE / CONNECTORS

Verbindungsstück T 180 Grad
Farben: Rohaluminium
Material: Aluminium

T connector 180 deg
colour: raw aluminium
material: aluminium

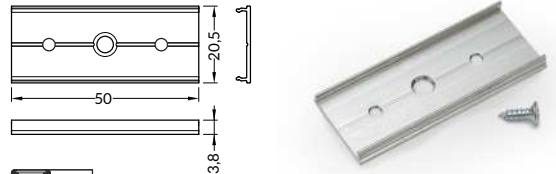

Artikelnummer = 1 Set
INDEX = 1 set

Rohaluminium
raw aluminium
95C6990000

Verbinder 90 Grad für SURFACE14
Farben: weiß, eloxiert, schwarz
Material: Aluminium

SURFACE14 connector 90 deg
colours: white, anodized, black
material: aluminium

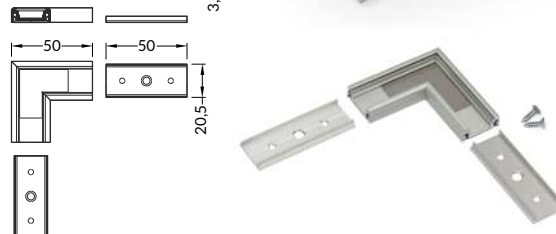

weiß lackiert
white painted
95A2990001

eloxiert
anodized
95A2990020

schwarz eloxiert
black anodized
95A2990021



EIN ÖKONOMISCHES LED PROFIL FÜR LED STREIFEN MIT 16 mm

ECONOMICAL PROFILE FOR 16 mm LED STRIP

- Sockel mit Slick Funktion - eine einfache Montage der Abdeckung
 - zwei Rillen - zwei Niveaus der Befestigung des Halters (mit einem Abstand von der Montagefläche und ohne Abstand)
 - eine homogene Lichtlinie (bei LED Streifen mit 120 leds/m und einer opalen Abdeckung)
 - maximale Breite des LED Streifens 16 mm
-
- SLICK socket - easy assembly technology
 - 2 channels for mounting bracket (with or without mounting surface distance)
 - continuous line of light (when using LED strip 120 P/m and opal cover)
 - maximum width of LED strip: 16 mm



ÄHNLICHES IM ANGEBOT / SIMILAR IN THE OFFER





B Abdeckung **B** einziehbar
B slide cover

C3 Abdeckung **C3** einclipsbar
C3 click cover

U4¹ Halter **U4**
U4 mounting plate

U4² Halter **U4** cone
cone U4 mounting plate

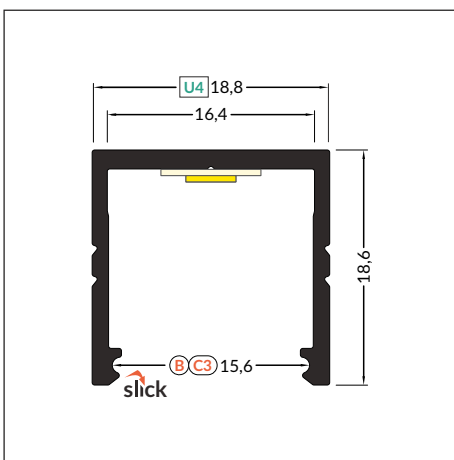
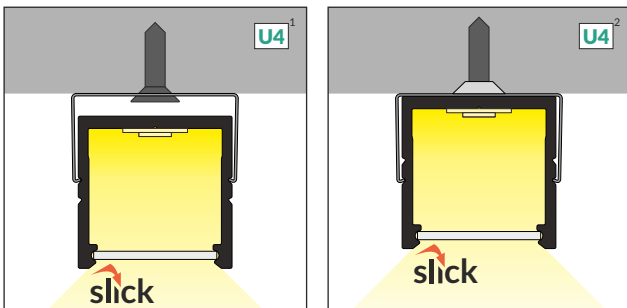
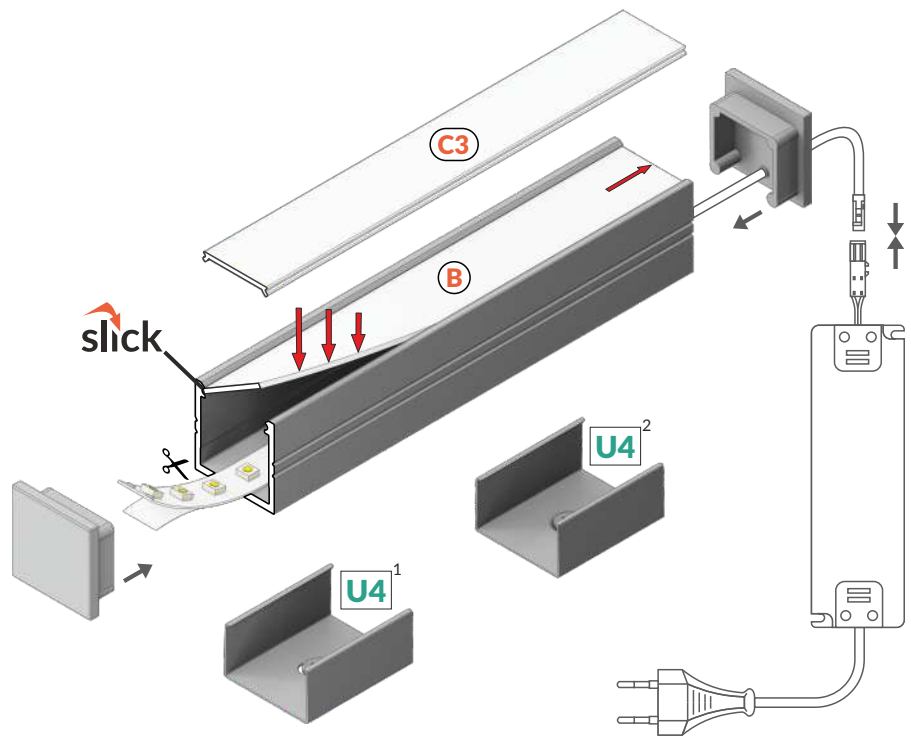

 max 16 mm

 Aufbauprofile
surface



Artikelnummer = 1 Stück, Länge 2.000 mm
INDEX = 1 pc, length 2000 mm

weiß lackiert
white painted
95F1020001

eloxiert
anodized
95F1020020

schwarz eloxiert
black anodized
95F1020021

Rohaluminium
raw aluminium
95F1020000

Die zugänglichen Längen: 1000 mm, 2000 mm, 3000 mm, 4000 mm.
Die standardmäßige Toleranz der Länge von Profilen beträgt: +20 mm.
Mehr Informationen >> 1.08.

Available lengths: 1000 mm, 2000 mm, 3000 mm, 4000 mm.
The standard profile length tolerance is +20 mm.
More details >> 1.08.



ABDECKUNG / COVERS

Abdeckung **B** einschiebbar
Farben: transparent, satiniert, opal
Material: PC, PP, PP

B slide cover
colours: transparent, frosted, opal
material: PC, PP, PP



Achtung! Die Abmessungen des Platzes für die Montage von LED Lichtquelle
Note! Dimensions of the space to install LED source

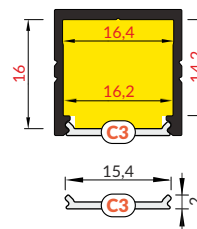
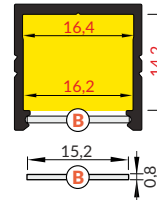

Abdeckung **C3** einclipbar
Farben: transparent, opal
Material: PMMA

NEU

C3 click cover
colours: transparent, opal
material: PMMA

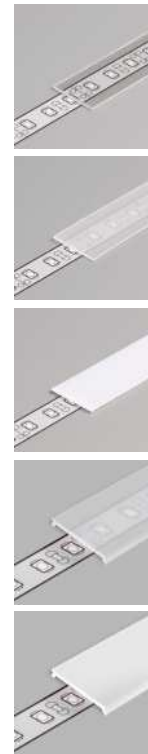

Länge 2.000 mm,
length 2000 mm

B transparent
Artikelnummer = 10 Stück
index = 10 pcs
9576250016

B satiniert / B frosted
Artikelnummer = 10 Stück
index = 10 pcs
9576250039

B opal
Artikelnummer = 10 Stück
index = 10 pcs
9576250038

C3 transparent
Artikelnummer = 1 Stück
index = 1 pc
95F1000216

C3 opal
Artikelnummer = 1 Stück
index = 1 pc
95F1000238

Die Toleranz der Länge von Abdeckungen beträgt: +20 mm.
Mehr Informationen >> 1.08.

The standard cover length tolerance is +20 mm.
More details >> 1.08.

ENDKAPPEN / ENDINGS

Endkappe **SMART16**
Farben: weiß, silbern, schwarz, grau
Material: ABS

SMART16 ending
colours: white, silver, black, grey
material: ABS

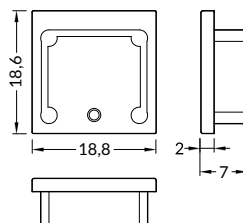

Die Endkappe mit Punkten für das Bohren von Öffnungen.
Ending with marked space to bore the holes.

Artikelnummer = 10 Sets = 20 Stück
INDEX = 10 sets = 20 pcs

weiß / white
95F1990001

silbern / silver
95F1990040

schwarz / black
95F1990002

grau / grey
95F1990022

HALTER / MOUNTINGS

Halter **U4**
Farben: weiß, inox, schwarz
Material: rostfreier Stahl

U4 mounting plate
colours: white, inox, black
material: stainless steel

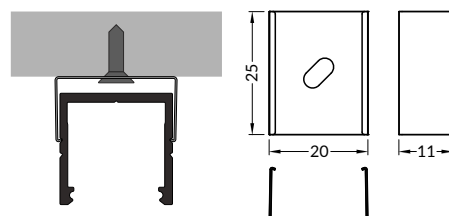

Halter **U4** cone
Farben: weiß, inox, schwarz
Material: rostfreier Stahl

cone **U4** mounting plate
colours: white, inox, black
material: stainless steel

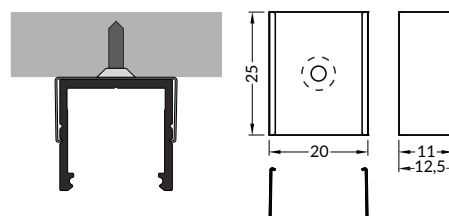

Artikelnummer = 10 Sets = 20 Stück
INDEX = 10 sets = 20 pcs

weiß / white
95F1970001

inox
95F1970019

schwarz / black
95F1970002

weiß / white
95F1980001

inox
95F1980019

schwarz / black
95F1980002



LINEA20 EF/TY

EIN LEISTUNGSFÄHIGES GEHÄUSE NACH METER

EFFICIENT LUMINAIRE CUT TO SIZE

- mehr als 20 Zubehörteile
 - die Möglichkeit der Montage an der Stromversorgung
 - die Befestigung der LED Module mit einer Klemme
 - Lichtecken
 - eine homogene Lichtlinie (bei LED Streifen mit 120 Leds/m und einer opalen Abdeckung)
 - maximale Breite des LED Streifens 20 mm
-
- over 20 accessories available
 - possibility of suspension along with the power supply
 - LED modules are assembled with extra clamps
 - angled connections illuminated
 - continuous light line (with 120 P/m LED strip and opal cover applied)
 - maximum LED source width: 20 mm



ÄHNLICHES IM ANGEBOT / SIMILAR IN THE OFFER





E Abdeckung **E** einschiebbar
E slide cover

F Abdeckung **F** einclipsbar
F click cover

E7 Abdeckung **E7** einclipsbar
E7 click cover

Y¹ Halter **Y** flexibel
Y flexible mounting plate

Y² Halter **Y** flexibel cone
cone Y flexible mounting plate

T Halter **T**
T mounting plate

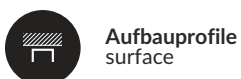
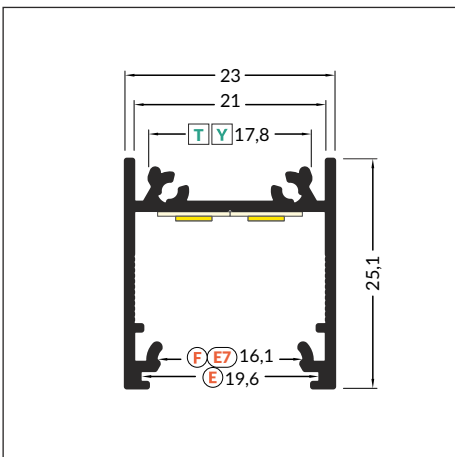
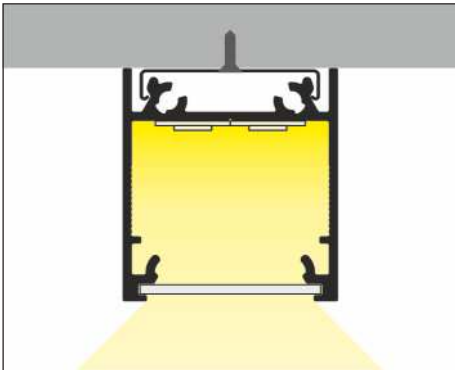
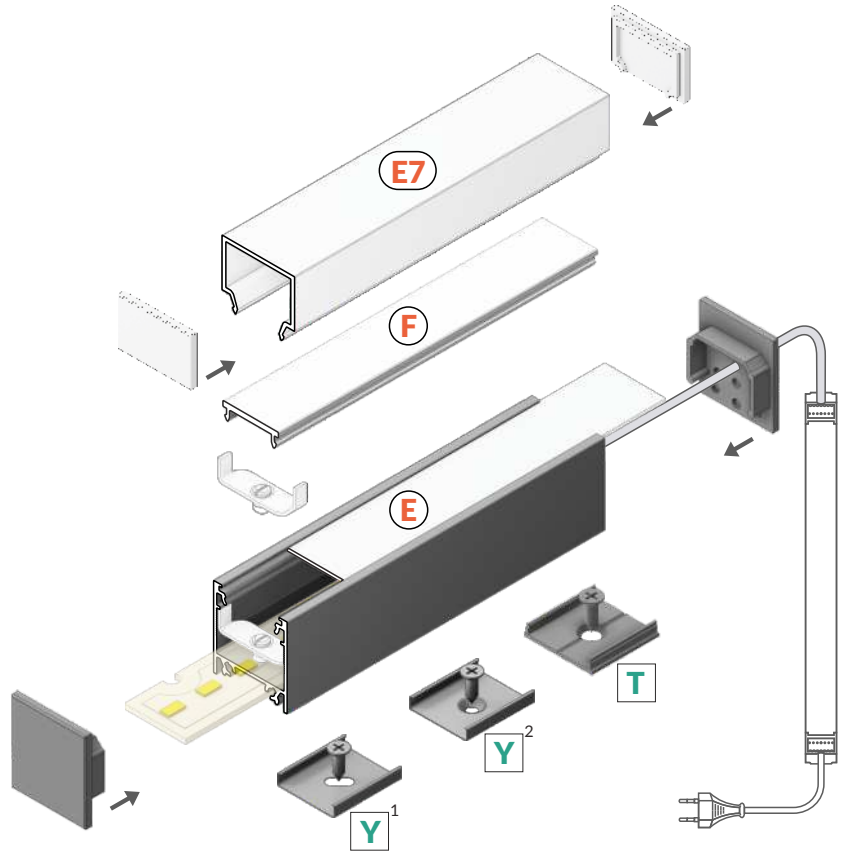

Artikelnummer = 1 Stück, Länge 2.000 mm
INDEX = 1 pc, length 2000 mm

weiß lackiert
white painted
95C1020001



eloxiert
anodized
95C1020020



schwarz eloxiert
black anodized
95C1020021



Rohaluminium
raw aluminium
95C1020000

Die zugänglichen Längen: 1000 mm, 2000 mm, 3000 mm, 4000 mm.
Die standardmäßige Toleranz der Länge von Profilen beträgt: +20 mm.
Mehr Informationen >> 1.08.

Available lengths: 1000 mm, 2000 mm, 3000 mm, 4000 mm.
The standard profile length tolerance is +20 mm.
More details >> 1.08.

LINEA20 EF/TY



EINE HOMOGENE LICHTLINIE
Wenn man die Verbindungsstück
LINEA20 mit 180° verwendet,
kann man eine ästhetische,
ununterbrochene Lichtlinie
in einer beliebigen Länge
erreichen.

CONTINUOUS LIGHT LINE
The LINEA20 180° connector
provides an aesthetic, continuous
light line of any length.



ABDECKUNG / COVERS

Abdeckung **E** einziehbar
Farben: transparent, satiniert, opal
Material: PC, PP, PP

E slide cover
colours: transparent, frosted, opal
material: PC, PP, PP



Achtung! Die Abmessungen des Platzes für die Montage von LED Lichtquelle
Note! Dimensions of the space to install LED source

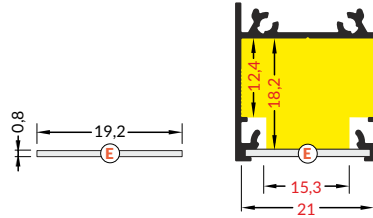

Abdeckung **F** einclipsbar
Farben: transparent, opal
Material: PMMA

F click cover
colours: transparent, opal
material: PMMA

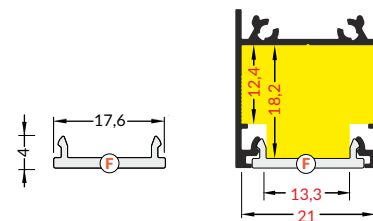

Abdeckung **E7** einclipsbar
Farben: opal
Material: PMMA

E7 click cover
colour: opal
material: PMMA

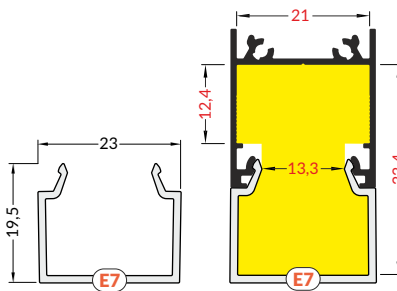

NEU

Länge 2.000 mm,
length 2000 mm

E transparent
Artikelnummer = 10 Stück
index = 10 pcs
95A2040016

E satiniert / **E** frosted
Artikelnummer = 10 Stück
index = 10 pcs
95A2040039

E opal
Artikelnummer = 10 Stück
index = 10 pcs
95A2040038

F transparent
Artikelnummer = 1 Stück
index = 1 pc
95A2060016

F opal
Artikelnummer = 1 Stück
index = 1 pc
95A2060038

Rolle, Länge 20 m,
reel, length 20 m

F opal
Artikelnummer = 1 Stück
index = 1 pc
95A2210038S

Länge 2.000 mm,
length 2000 mm

E7 opal
Artikelnummer = 1 Stück
index = 1 pc
95C1080038

Die Toleranz der Länge von Abdeckungen beträgt: +20 mm.
Mehr Informationen >> 1.08.

The standard cover length tolerance is +20 mm.
More details >> 1.08.

Artikelnummer = 1 Set = 2 Stück
INDEX = 1 set = 2 pcs

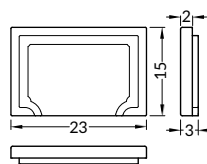

Endkappe **E7** opal
E7 opal ending
95C1840038



MONTAGETEIL FÜR LED / LED MOUNTING

Montageteil LED für LINEA20
Material: Aluminium

LINEA20 LED mounting
material: aluminium

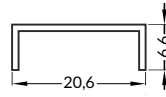

Artikelnummer = 1 Stück, Länge 2.000 mm
INDEX = 1 pc, length 2000 mm

Rohaluminium
raw aluminium
95C6060000

Die lieferbaren Längen: 1000 mm, 2000 mm, 3000 mm, 4000 mm. Die standardmäßige Toleranz der Länge von Profilen beträgt: +20 mm. Mehr Informationen >> 1.08.

Available lengths: 1000 mm, 2000 mm, 3000 mm, 4000 mm. The standard profile length tolerance is +20 mm. More details >> 1.08.

LEUCHTEFFEKT / LIGHTING EFFECT

LED Montageteil für LINEA20 + LED Klemme LINEA20-1 / LINEA20 LED mounting + LINEA20-1 LED clamp



Leuchteffekt ohne die Einschleibplatte für LED bei dem Profil LINEA20 zu verwenden / Lighting effect without LINEA20 LED mounting





KLEMME / CLAMP

LED Klemme LINEA20
Farben: weiß
Material: Stahl, Kunststoff

LINEA20 LED clamp
colour: white
material: painted steel, plastic

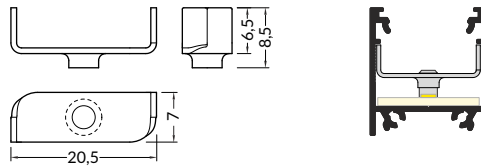

Artikelnummer = 10 Sets = 20 Stück
INDEX = 10 sets = 20 pcs

weiß / white
95C6940001

LED Klemme LINEA20-1
Farben: weiß
Material: Stahl, Kunststoff

LINEA20-1 LED clamp
colour: white
material: painted steel, plastic

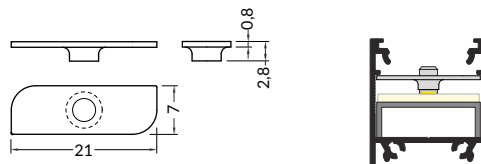

weiß / white
95C6930001

ENDKAPPEN / ENDINGS

Endkappe LINEA20
Farben: weiß, silbern, schwarz, grau
Material: ABS

LINEA20 ending
colours: white, silver, black, grey
material: ABS

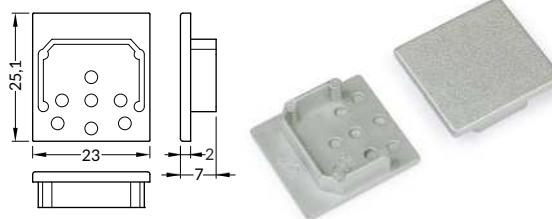

Artikelnummer = 10 Sets = 20 Stück
INDEX = 10 sets = 20 pcs

weiß / white
95C1940001
silbern / silver
95C1940040
schwarz / black
95C1940002
grau / grey
95C1940022



Die Endkappe mit Punkten für das Bohren von Öffnungen.
Es besteht die Möglichkeit spezielle Schrauben zu kaufen.
Ending with marked space to bore the holes.
Possibility of buying dedicated screws.

Endkappe LINEA20-E7
Farben: weiß, silbern, schwarz, grau
Material: ABS

LINEA20-E7 ending
colours: white, silver, black, grey
material: ABS

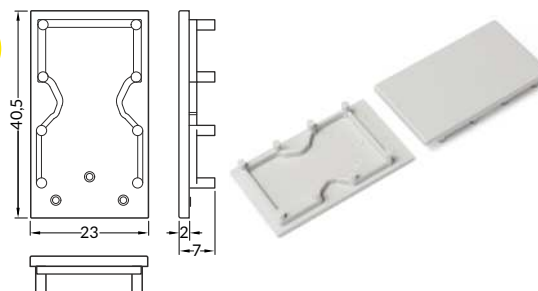

weiß / white
95C1999901
silbern / silver
95C1999940
schwarz / black
95C1999902
grau / grey
95C1999922



Die Endkappe mit Punkten für das Bohren von Öffnungen.
Es besteht die Möglichkeit spezielle Schrauben zu kaufen.
Ending with marked space to bore the holes.
Possibility of buying dedicated screws.

Schrauben für die Endkappen
Farben: weiß, silbern, schwarz, inox

screws for LED endings
colours: white, silver, black, inox



Artikelnummer = 10 Sets = 40 Stück
INDEX = 10 sets = 40 pcs

weiß / white
95B1900001
silbern / silver
95B1900040
schwarz / black
95B1900002
inox
95B1900019

LINEA20 EF/TY

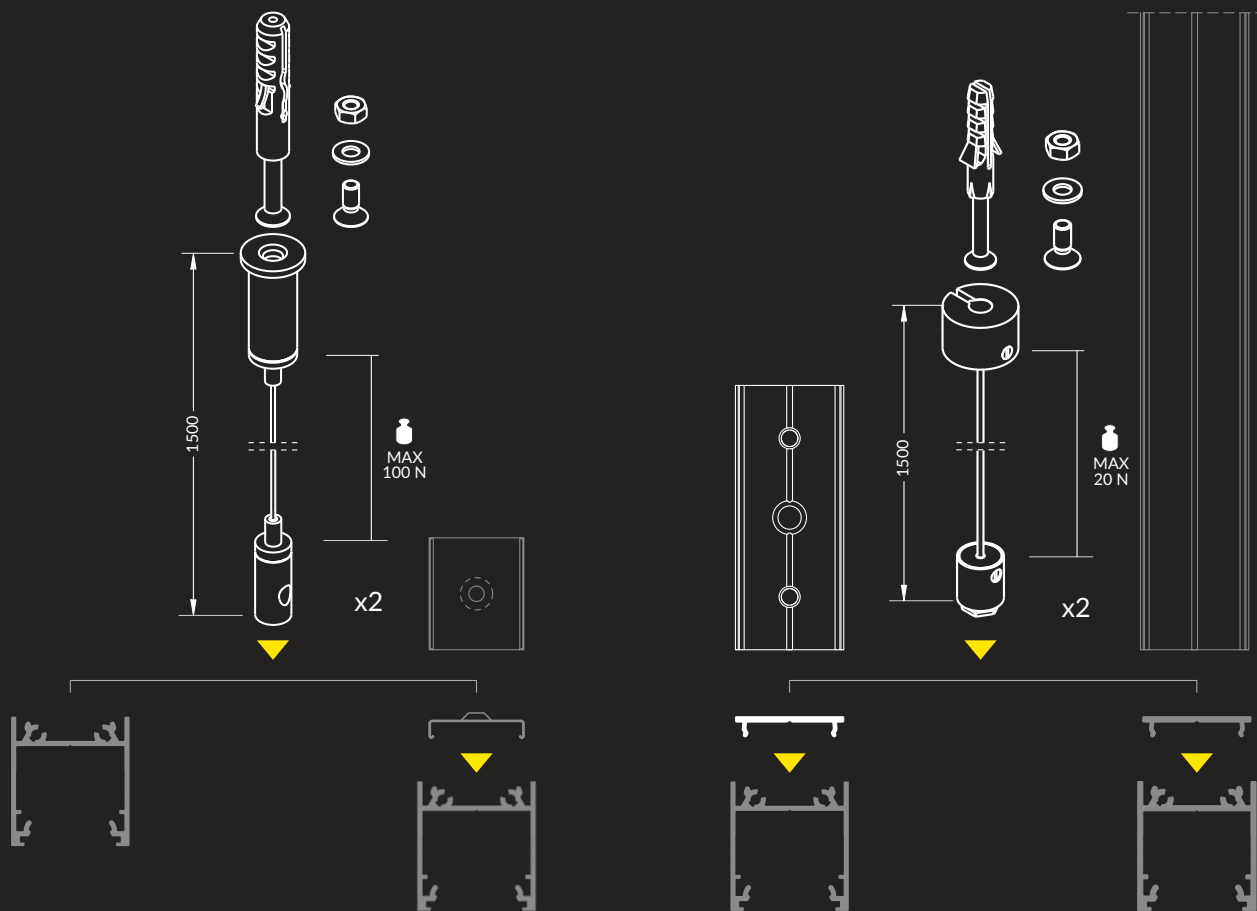

ABHÄNGUNG FÜR LED PROFIL-HALTER 1500
Die Anpassung an die flexiblen Halter ermöglicht eine schnelle und einfache Montage der Gehäuse. Möglich ist auch die Montage direkt an das Profil.

SLING FOR LED MOUNTING 1500
Compatible with flexible mounting plates, allows fast and easy assembly of the luminaire. Possibility of direct mounting to the profile.

STROMLEITENDE ABHÄNGUNG SELV 50 V 1500
Es sichert schlichtes Aussehen - ohne die Notwendigkeit zusätzliche Kabel durchzuführen.

SELV SLING 50 V 1500
It provides a minimalistic look - no additional wires required.

Bei dem Anwenden von dem Profil FIX16 bildet man eine ästhetische, vom Oben geschlossene Gehäuse.

Using FIX16 profile creates an aesthetic, closed from the top, luminaire.

In dem Profil FIX16 soll man die Montagelöcher von Ø 5 mm bohren
Drill Ø 5 mm mounting holes in FIX16



HALTER / MOUNTINGS

Halter Y flexibel
Farben: inox
Material: rostfreier Stahl
Y flexible mounting plate
colour: inox
material: stainless steel

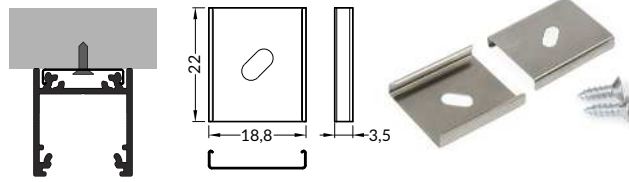

Artikelnummer = 10 Sets = 20 Stück
INDEX = 10 sets = 20 pcs

inox
95A2090019

Halter Y flexibel cone
Farben: inox
Material: rostfreier Stahl
cone Y flexible mounting plate
colour: inox
material: stainless steel

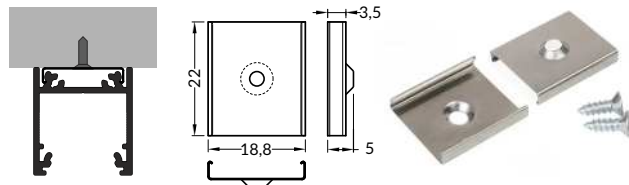

inox
95A2130019

Halter T
Farben: Rohaluminium
Material: Aluminium
T mounting plate
colour: raw aluminium
material: aluminium

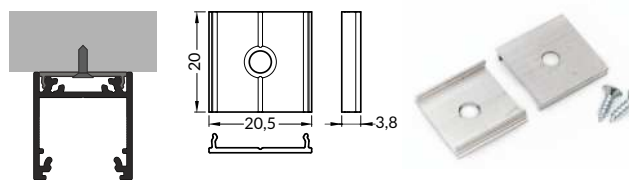

Rohaluminium
raw aluminium
95C6960000

ALUMINIUMABDECKPLATTE / ALUMINIUM COVER

LED Profil FIX16
Farben: weiß, eloxiert, schwarz, Rohaluminium
Material: Aluminium
LED profile FIX16
colours: white, anodized, black, raw aluminium
material: aluminium

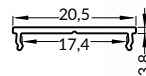

Die zugänglichen Längen: 1000 mm, 2000 mm, 3000 mm, 4000 mm.
Die standardmäßige Toleranz der Länge von Profilen beträgt: +20 mm. Mehr Informationen >> 1.08.
Available lengths: 1000 mm, 2000 mm, 3000 mm, 4000 mm.
The standard profile length tolerance is +20 mm. More details >> 1.08.

Artikelnummer = 1 Stück, Länge 2.000 mm
INDEX = 1 pc, length 2000 mm

weiß lackiert
white painted
95C6020001

eloxiert
anodized
95C6020020

schwarz eloxiert
black anodized
95C6020021

Rohaluminium
raw aluminium
95C6020000

ABHÄNGUNG / SLING

Abhängung SELV 50V 1500
Farben: weiß, silbern, schwarz
SELV sling 50 V 1500
colours: white, silver, black



Artikelnummer = 1 Set = 2 Stück
INDEX = 1 set = 2 pcs

weiß / white
9567120001

silbern / silver
9567120040

schwarz / black
9567120002

Abhängung für LED Profil-Halter 1500
Farben: Chrom
sling for LED mounting 1500
colour: chrome



Chrom / chrome
9567140003

LINEA20 EF/TY

VERBINDUNGSMÖGLICHKEITEN CONNECTION POSSIBILITY



60°



90°



120°



135°

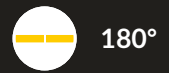

180°

ECKVERBINDER

Dank der Eckverbinder mit fünf unterschiedlichen Winkeln (60° / 90° / 120° / 135° / 180°) ist die Bildung von vielen unterschiedlichen Lichtvarianten möglich ohne das Profil auf Gehrung zuschneiden zu müssen.

Gebogene Verbindungsstücke ermöglichen das Verbinden von zwei Profilen in zwei Ebenen, unter zwei Winkeln; dem inneren Winkel von 90° und dem äußeren Winkel von 270°.

ANGULAR CONNECTORS

Thanks to five different angle connectors (60° / 90° / 120° / 135° / 180°) it is possible to create many various lighting systems – with no need to cut the profile at an angle.

Bent connectors allows to connect profiles in two planes, at two angles: 90° on the inside and 270° on the outside.



Ein Element aus durchsichtigem Kunststoff sichert die Stabilisierung der Verbindung und gleichzeitig lässt sie das Licht durch. Diese Lösung ermöglicht das Leuchten der Gehäuse auf der ganzen Fläche - auch in den Ecken.

The component made of clear fabric provides secure connection, letting light through at the same time. Thanks to that, the luminaire can illuminate on the entire surface of the cover – even in the corners.



VERBINDUNGSTÜCKE / CONNECTORS

Verbinder 60 Grad für LINEA20
Farben: weiß, eloxiert, schwarz
Material: Aluminium, Polycarbonat

LINEA20 connector 60 deg
colours: white, anodized, black
material: aluminium, polycarbonate

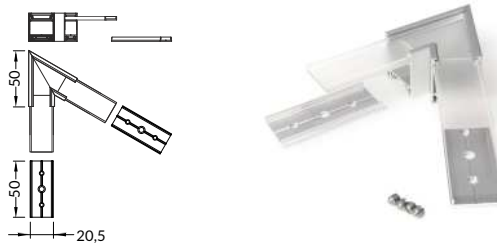

Verbinder 90 Grad für LINEA20
Farben: weiß, eloxiert, schwarz
Material: Aluminium, Polycarbonat

LINEA20 connector 90 deg
colours: white, anodized, black
material: aluminium, polycarbonate

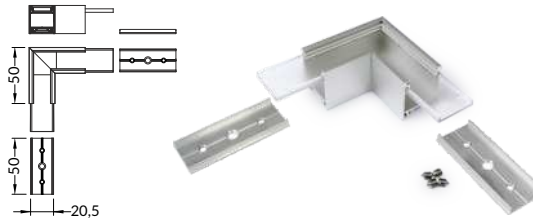

Verbinder 90 Grad für LINEA20 gebogen
Farben: weiß, eloxiert, schwarz
Material: Aluminium, Polycarbonat

LINEA20 connector 90 deg bent
colours: white, anodized, black
material: aluminium, polycarbonate

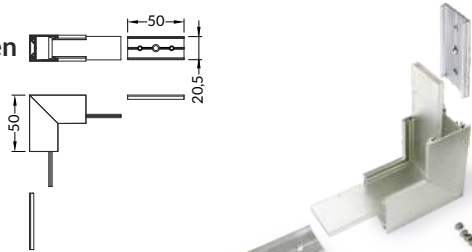

Verbinder 120 Grad für LINEA20
Farben: weiß, eloxiert, schwarz
Material: Aluminium, Polycarbonat

LINEA20 connector 120 deg
colours: white, anodized, black
material: aluminium, polycarbonate

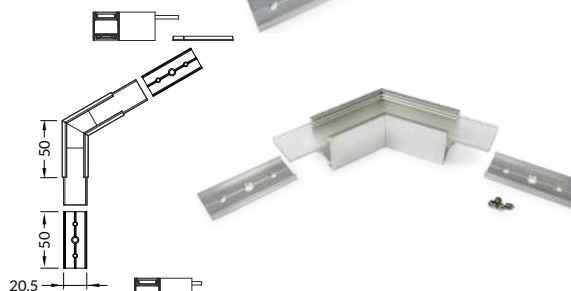

Verbinder 135 Grad für LINEA20
Farben: weiß, eloxiert, schwarz
Material: Aluminium, Polycarbonat

LINEA20 connector 135 deg
colours: white, anodized, black
material: aluminium, polycarbonate

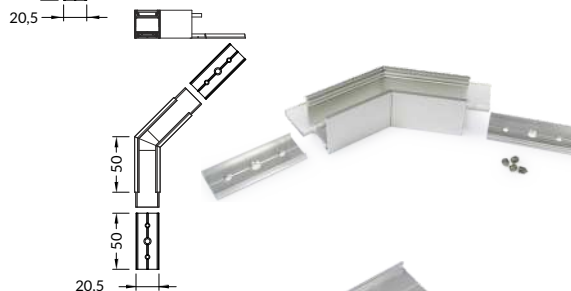

Verbinder 180 Grad für LINEA20
Material: Aluminium, Polycarbonat

LINEA20 connector 180 deg
material: aluminium, polycarbonate



Verbinder 270 Grad für LINEA20 gebogen
Farben: weiß, eloxiert, schwarz
Material: Aluminium, Polycarbonat

LINEA20 connector 270 deg bent
colours: white, anodized, black
material: aluminium, polycarbonate

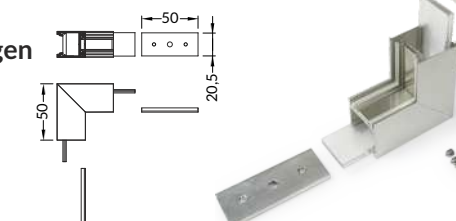

Artikelnummer = 1 Set
INDEX = 1 set

weiß lackiert / white painted
95C1850001

eloxiert / anodized
95C1850020

schwarz eloxiert / black anodized
95C1850002

weiß lackiert / white painted
95C1860001

eloxiert / anodized
95C1860020

schwarz eloxiert / black anodized
95C1860002

weiß lackiert / white painted
95C1870001

eloxiert / anodized
95C1870020

schwarz eloxiert / black anodized
95C1870002

weiß lackiert / white painted
95C1880001

eloxiert / anodized
95C1880020

schwarz eloxiert / black anodized
95C1880002

weiß lackiert / white painted
95C1890001

eloxiert / anodized
95C1890020

schwarz eloxiert / black anodized
95C1890002

95C1900000

weiß lackiert / white painted
95C1910001

eloxiert / anodized
95C1910020

schwarz eloxiert / black anodized
95C1910002

LINEA20 EF/TY





PENDELLEUCHE

Dank vielen Zubehörteilen kann man das Profil für viele Anwendungen einsetzen. Die Abhängung SELV 50 V 1500 und das Abdeckprofil FIX16 ermöglicht das Bauen einer Pendelleuchte mit einem kleinen Durchmesser, aber die viel, starkes Licht gibt.

PENDANT LUMINAIRE

Thanks to wide range of profile accessories it could be applied in many arrangements. SELV sling 50 V 1500 and FIX16 closing profile allows to create pendant luminaire with a small intersection, but strong light.

EIN BREITES ALUMINIUMPROFIL FÜR AUFBAU

WIDE, ALUMINIUM, SURFACE PROFILE

- man kann gleichzeitig drei LED Streifen mit 8 mm Breite verwenden
- Sockel mit Slick Funktion
- maximale Breite des LED Streifens 24 mm
- possibility of installing 3 8 mm LED strips
- Slick socket
- maximum LED strip width: 24 mm



ÄHNLICHES IM ANGEBOT / SIMILAR IN THE OFFER





G Abdeckung **G** einschiebbar
G slide cover

W Halter **W** flexibel cone
cone **W** flexible mounting plate

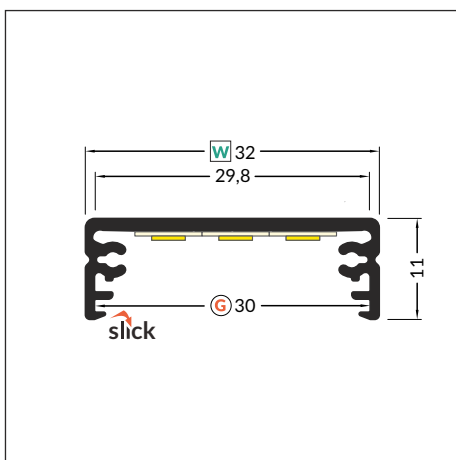
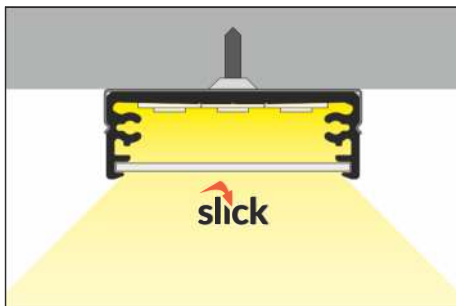
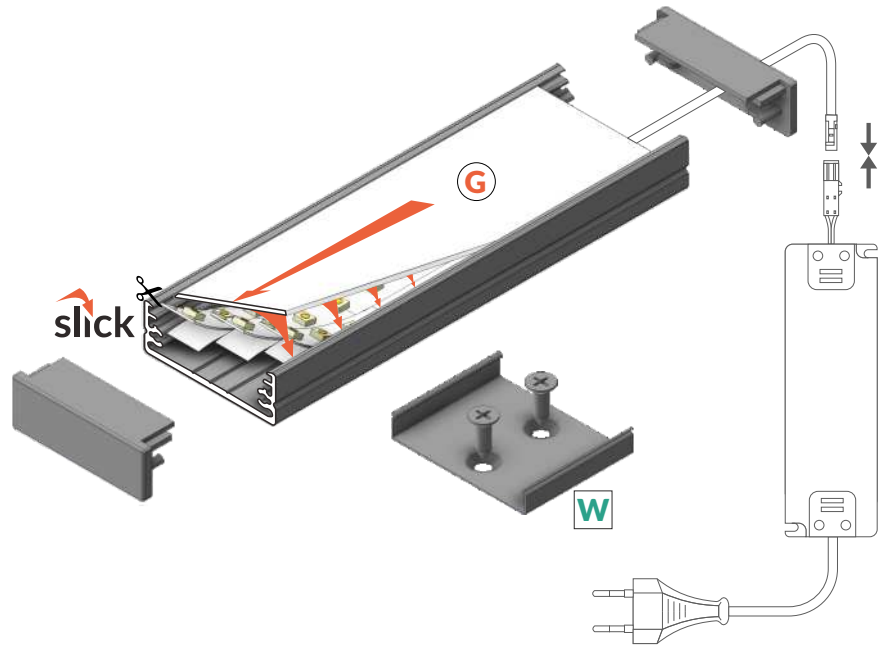

 max 24 mm

 Aufbauprofile
surface



Artikelnummer = 1 Stück, Länge 2.000 mm
INDEX = 1 pc, length 2000 mm

weiß lackiert
white painted
9584030001



eloxiert
anodized
9584030020



schwarz eloxiert
black anodized
9584030021



Rohaluminium
raw aluminium
9584030000

Die zugänglichen Längen: 1000 mm, 2000 mm, 3000 mm, 4000 mm.
Die standardmäßige Toleranz der Länge von Profilen beträgt: +20 mm.
Mehr Informationen >> 1.08.

Available lengths: 1000 mm, 2000 mm, 3000 mm, 4000 mm.
The standard profile length tolerance is +20 mm.
More details >> 1.08.



ABDECKUNG / COVERS

Abdeckung **G** einziehbar
Farben: transparent, satiniert, opal
Material: PC, PP, PP

G slide cover
colours: transparent, frosted, opal
material: PC, PP, PP



Achtung! Die Abmessungen des Platzes für die Montage von LED Lichtquelle
Note! Dimensions of the space to install LED source

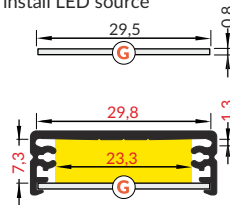

Länge 2.000 mm,
length 2000 mm

G transparent
Artikelnummer = 10 Stück
index = 10 pcs

9584070016

G satiniert / **G** frosted
Artikelnummer = 10 Stück
index = 10 pcs

9584070039

G opal
Artikelnummer = 10 Stück
index = 10 pcs

9584070038

Die Toleranz der Länge von Abdeckungen beträgt: +20 mm.
Mehr Informationen >> 1.08.

The standard cover length tolerance is +20 mm.
More details >> 1.08.

ENDKAPPEN / ENDINGS

Endkappe WIDE24
Farben: weiß, silbern, schwarz, grau
Material: ABS
WIDE24 ending
colours: white, silver, black, grey
material: ABS

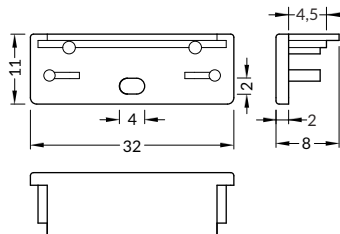

Artikelnummer = 10 Sets = 20 Stück
INDEX = 10 sets = 20 pcs

weiß / white
9584040001

silbern / silver
9584040040

schwarz / black
9584040002

grau / grey
9584040022

Endkappe WIDE24 mit Öffnung
Farben: weiß, silbern, schwarz, grau
Material: ABS
WIDE24 ending with hole
colours: white, silver, black, grey
material: ABS



weiß / white
9584300001

silbern / silver
9584300040

schwarz / black
9584300002

grau / grey
9584300022

HALTER / MOUNTINGS

Halter **W** flexibel cone
Farben: weiß, inox, schwarz
Material: rostfreier Stahl

cone **W** flexible mounting plate
colour: white, inox, black
material: stainless steel

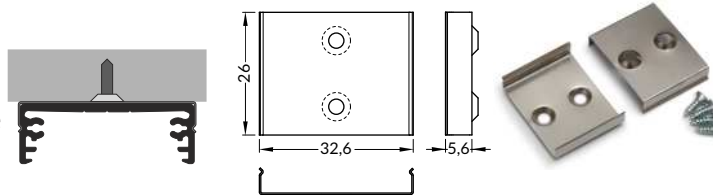

Artikelnummer = 10 Sets = 20 Stück
INDEX = 10 sets = 20 pcs

weiß / white
9584510001

inox
9584510019

schwarz / black
9584510002

Halter WIDE24 einfach
Material: verzinkter Stahl

WIDE24 simple holder
material: zinc coated steel

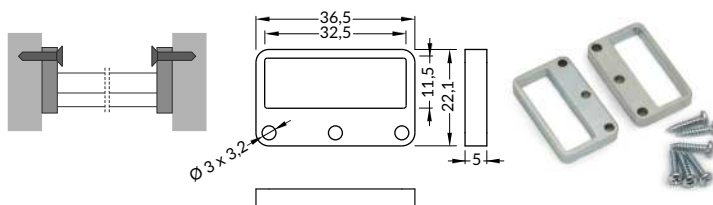

Artikelnummer = 1 Set = 2 Stück
INDEX = 1 set = 2 pcs

verzinkt
zinc coated
9584220030



ABHÄNGUNG / SLING

Abhängung SELV 50V 1500
Farben: weiß, silbern, schwarz

SELV sling 50 V 1500
colours: white, silver, black

Abhängung für LED Profil-Halter 1500
Farben: Chrom

sling for LED mounting 1500
colour: chrome



Artikelnummer = 1 Set = 2 Stück
INDEX = 1 set = 2 pcs

weiß / white
9567120001

silbern / silver
9567120022

schwarz / black
9567120002

Chrom / chrome
9567140003



FLAT8 H/UX

EIN FLACHES EINBAUPROFIL, DAS EINEN GERSTREUTEN LICHTSCHEIN EMITTIERT

FLAT RECESSED PROFILE EMITTING DIFFUSED LIGHT GLOW

- dekorative Beleuchtung
- ein parabelförmiger Reflektor - gleiches, weiches und gestreutes Licht
- ein flaches Profil, das in die Dicke der Rigipsplatte passt, die Montage gelingt ohne in den Rahmenbau einzugreifen
- die Montage an die Möbel, Wände, in die Sockel mit Hilfe von Haltern (durch Einclipsen) oder direkt (durch das Zuschrauben oder Einkleben)
- maximale Breite des LED Streifens 8 mm

- decorative illumination
- a parabolic, reflecting element - even, smooth, diffused light
- a flat profile, designed to fit into plasterboards - installation without interference in the frame construction
- mounted to furniture, walls, pedestals with holders (click-in) or directly (with screws, adhesive tape or glue)
- maximum LED strip width: 8 mm



ÄHNLICHES IM ANGEBOT / SIMILAR IN THE OFFER

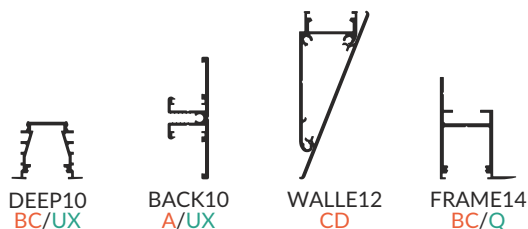



H Abdeckung **H** einschiebbar
H slide cover

U¹ Halter **U** flexibel
U flexible mounting plate

U² Halter **U** flexibel cone
cone U flexible mounting plate

X¹ Halter **X**
X mounting plate

X² Halter **X** Feder
spring X mounting plate

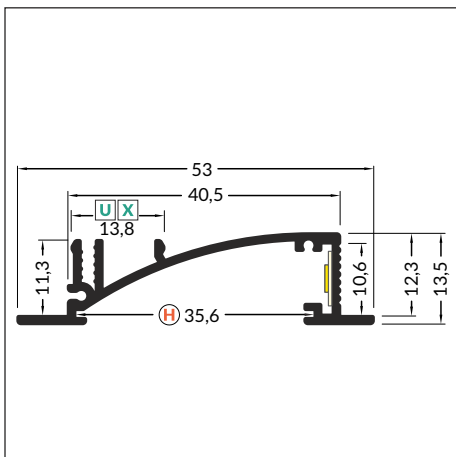
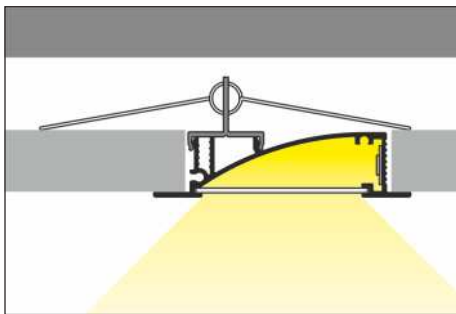
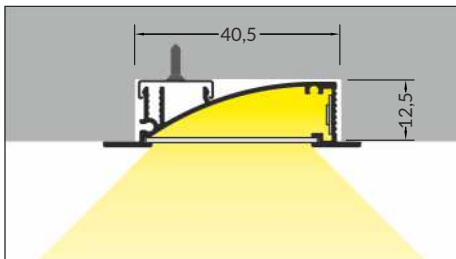
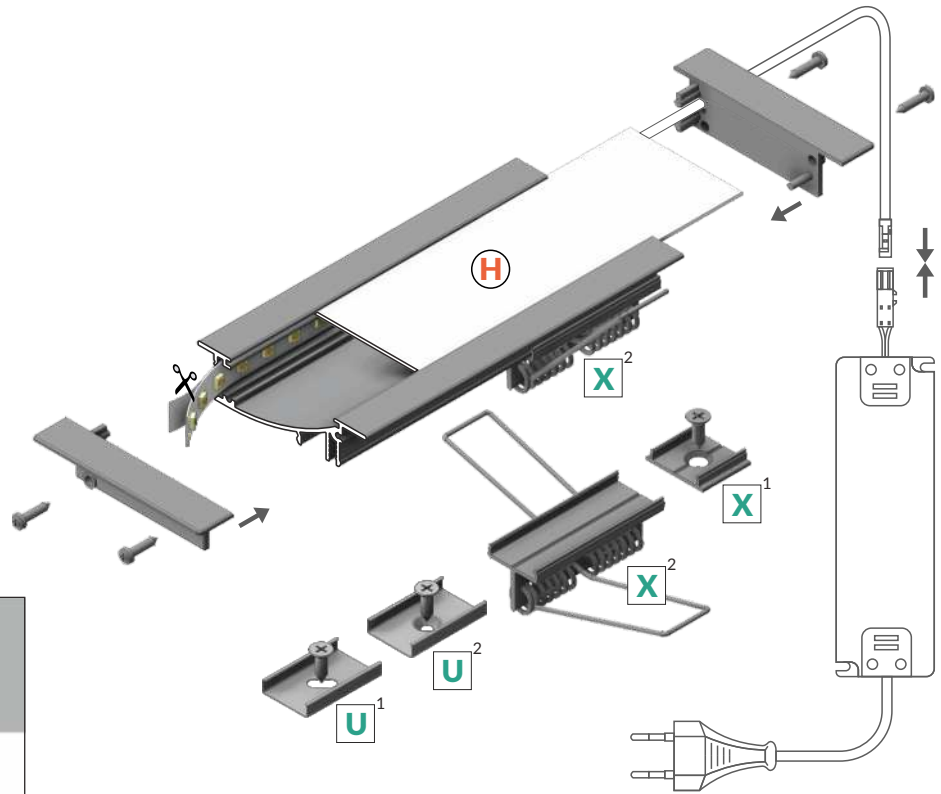

 max 8 mm

 Einbauprofile
recessed



Artikelnummer = 1 Stück, Länge 2.000 mm
INDEX = 1 pc, length 2000 mm

weiß lackiert
white painted
9523050001



eloxiert
anodized
9523050020



schwarz eloxiert
black anodized
9523050021



Rohaluminium
raw aluminium
9523050000

Die zugänglichen Längen: 1000 mm, 2000 mm, 3000 mm, 4000 mm.
Die standardmäßige Toleranz der Länge von Profilen beträgt: +20 mm.
Mehr Informationen >> 1.08.

Available lengths: 1000 mm, 2000 mm, 3000 mm, 4000 mm.
The standard profile length tolerance is +20 mm.
More details >> 1.08.



ABDECKUNG / COVERS

Abdeckung **H** einschiebbar
Farben: transparent, satiniert, opal
Material: PC, PP, PP

H slide cover
colours: transparent, frosted, opal
material: PC, PP, PP



Achtung! Die Abmessungen des Platzes für die Montage von LED Lichtquelle
Note! Dimensions of the space to install LED source

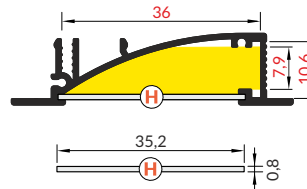

Länge 2.000 mm,
length 2000 mm

H transparent
Artikelnummer = 10 Stück
index = 10 pcs

9523080016

H satiniert / **H** frosted
Artikelnummer = 10 Stück
index = 10 pcs

9523080039

H opal
Artikelnummer = 10 Stück
index = 10 pcs

9523080038

Die Toleranz der Länge von Abdeckungen beträgt: +20 mm.
Mehr Informationen >> 1.08.

The standard cover length tolerance is +20 mm.
More details >> 1.08.

ENDKAPPEN / ENDINGS

Endkappe **FLAT8** mit Öffnung
Farben: weiß, silbern, schwarz, grau
Material: ABS

FLAT8 ending with hole
colours: white, silver, black, grey
material: ABS

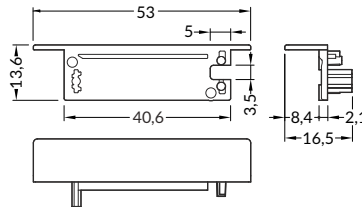

Artikelnummer = 10 Sets = 20 Stück
INDEX = 10 sets = 20 pcs

weiß / white
9523110001

silbern / silver
9523110040

schwarz / black
9523110002

grau / grey
9523110022

HALTER / MOUNTINGS

Halter **U** flexibel
Farben: inox
Material: rostfreier Stahl

U flexible mounting plate
colour: inox
material: stainless steel

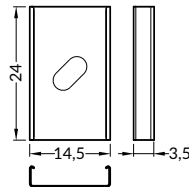
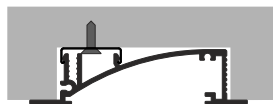

inox
9576380000

Halter **U** flexibel cone
Farben: inox
Material: rostfreier Stahl

cone **U** flexible mounting plate
colour: inox
material: stainless steel

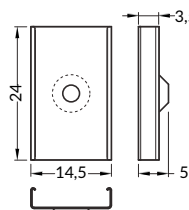
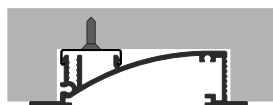

inox
9576620000

Halter **X**
Farben: Rohaluminium
Material: Aluminium

X mounting plate
colour: raw aluminium
material: aluminium

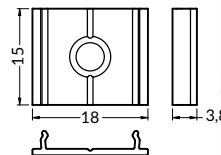
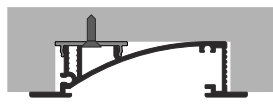

Rohaluminium
raw aluminium
9576260000

Halter **X** Feder
Farben: Rohaluminium
Material: Aluminium

spring **X** mounting plate
colour: raw aluminium
material: aluminium

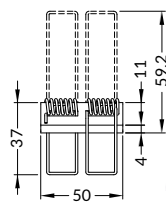
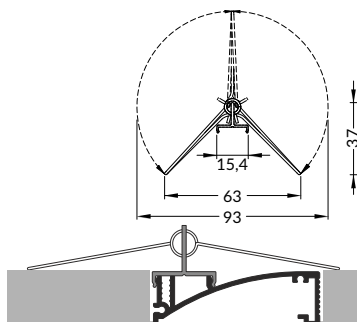

Artikelnummer = 1 Stück
INDEX = 1 pc

Rohaluminium
raw aluminium
9523130000



VERBINDUNGSTÜCKE / CONNECTORS

Verbindungsstück X 180 Grad
Farben: Rohaluminium
Material: Aluminium

X connector 180 deg
colour: raw aluminium
material: aluminium

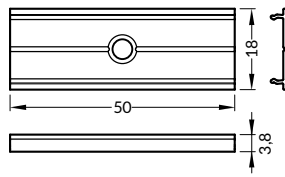

Artikelnummer = 1 Set
INDEX = 1 set

Rohaluminium
raw aluminium
9576350000



HI8 C1

EINE SCHMALE LICHTLINIE

THIN LINE OF LIGHT

- dekorative Beleuchtung
 - für die Montage in dem Rand von Platten, Treppen
 - an die Montagefläche angepasst
 - sichtbar ist nur die leuchtende Oberfläche der Abdeckung
 - kleine Abmessungen
 - maximale Breite des LED Streifens 8 mm
-
- decorative illumination
 - for counter edges, steps
 - flushes with mounting surface
 - only enlight surface of the cover is visible
 - miniature dimensions
 - maximum width of LED strip: 8 mm



ÄHNLICHES IM ANGEBOT / SIMILAR IN THE OFFER

SLASH8

FLOOR12
K/U

SMART-IN10
AC2/Z



C1 Abdeckung C1 einclipsbar
C1 click cover

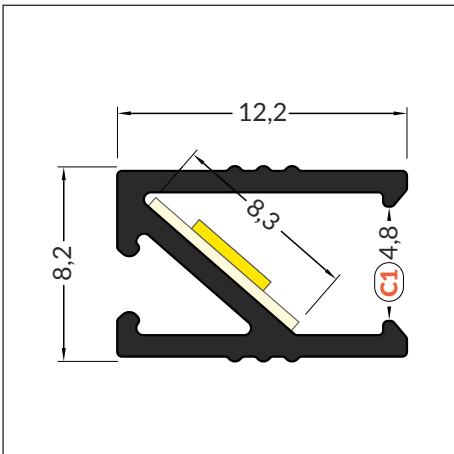
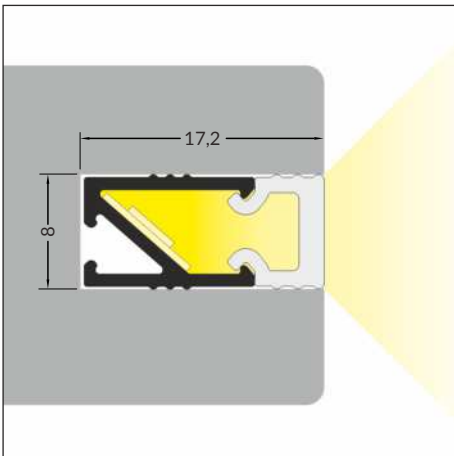
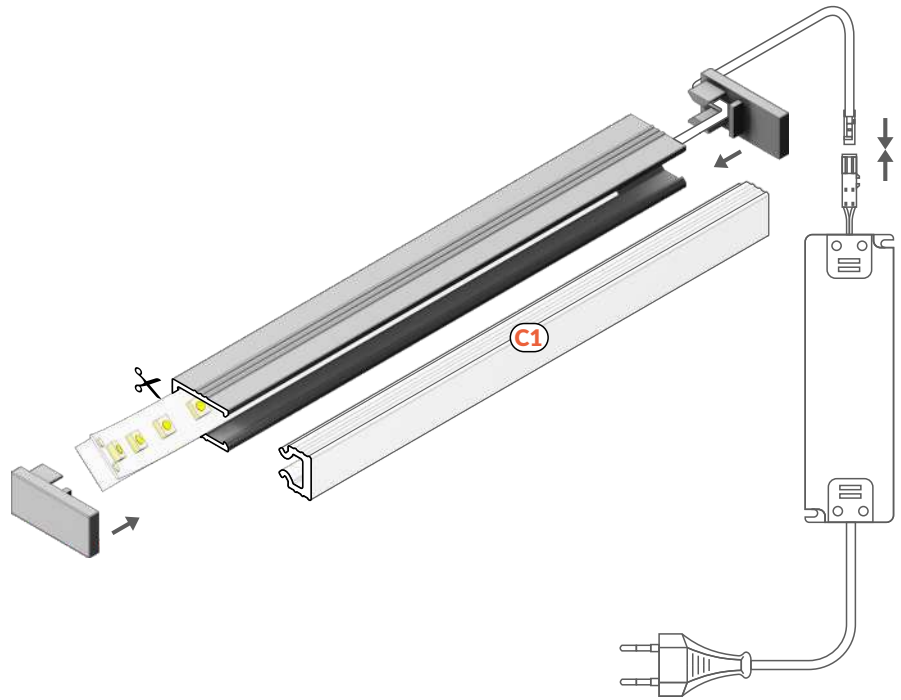

Artikelnummer = 1 Stück, Länge 2.000 mm
INDEX = 1 pc, length 2000 mm

eloxiert
anodized
95H8020020

Die zugänglichen Längen: 1000 mm, 2000 mm, 3000 mm, 4000 mm.
Die standardmäßige Toleranz der Länge von Profilen beträgt: +20 mm.
Mehr Informationen >> 1.08.

Available lengths: 1000 mm, 2000 mm, 3000 mm, 4000 mm.
The standard profile length tolerance is +20 mm.
More details >> 1.08.



max 8 mm



Einbauprofile
recessed



ABDECKUNG / COVERS

Abdeckung **C1** einclipsbar
Farben: opal
Material: PMMA

C1 click cover
colours: opal
material: PMMA



Achtung! Die Abmessungen des Platzes für die Montage von LED Lichtquelle
Note! Dimensions of the space to install LED source

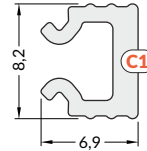
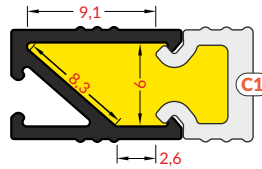

Länge 2,000 mm,
length 2000 mm

C1 opal
Artikelnummer = 1 Stück
index = 1 pc
95H8060038

Die Toleranz der Länge von Abdeckungen beträgt: +20 mm.
Mehr Informationen >> 1.08.
The standard cover length tolerance is +20 mm.
More details >> 1.08.

ENDKAPPEN / ENDINGS

Endkappe HI8
Farben: silbern, grau, opal
Material: ABS, ABS, PMMA
HI8 ending
colours: silver, grey, opal
material: ABS, ABS, PMMA

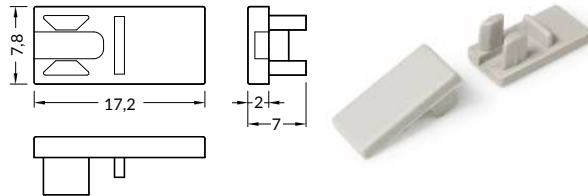

Artikelnummer = 10 Sets = 20 Stück
INDEX = 10 sets = 20 pcs

silbern / silver
95H8990040

grau / grey
95H8990022

opal
95H8990038



SEHR DÜNNE LICHTLINIE

STRING OF LIGHT

- einfache Montage des LED Streifens
 - Montage in einem kleinen Spalt 5x14 mm
 - Möglichkeit der Montage nach einem Bogen (Mindestbiegeradius 25 cm)
 - eine homogene Lichtlinie (bei LED Streifen mit 120 leds/m)
 - Breite des LED Streifens 8 mm
-
- easy installation of the LED strip
 - installation in a small gap 5x14 mm
 - possibility of installation in an arc (minimum bending radius 25 cm)
 - continous line of light when using 120 P/m LED strip
 - width of LED strip: 8 mm



ÄHNLICHES IM ANGEBOT / SIMILAR IN THE OFFER

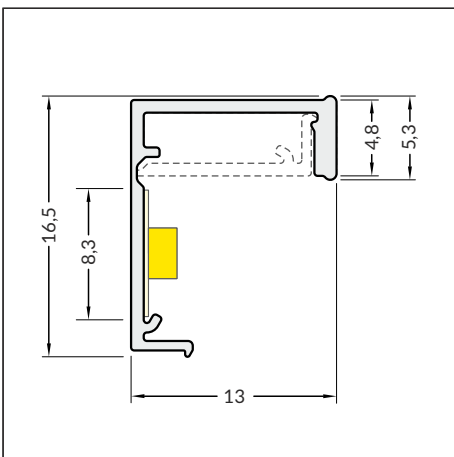
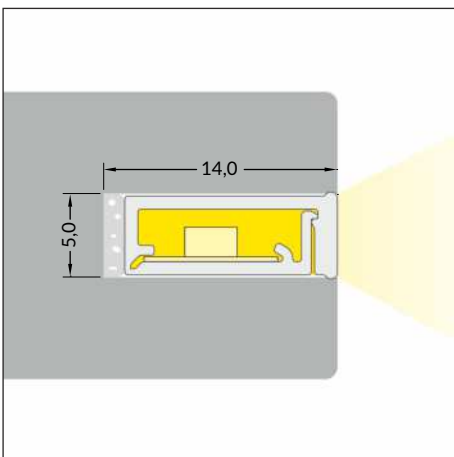
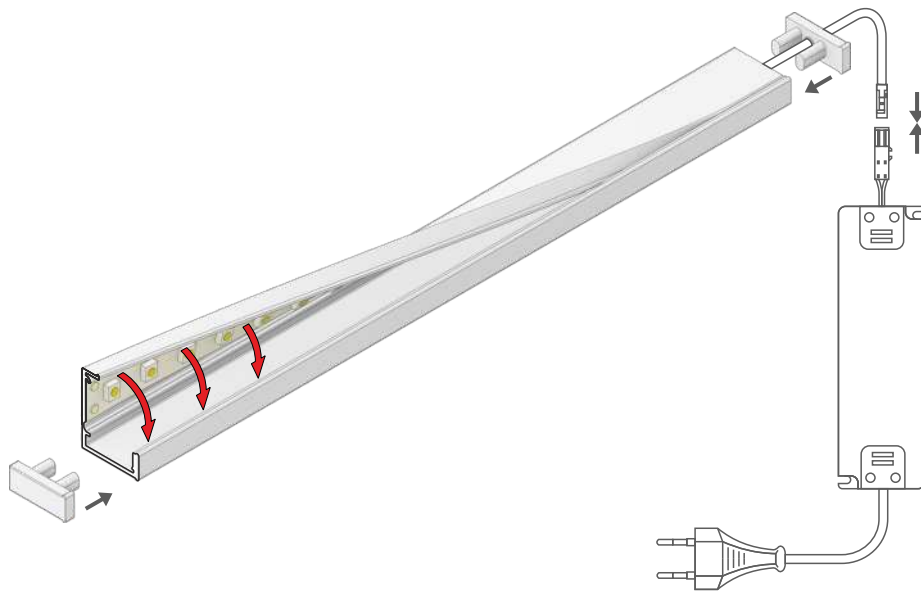

Artikelnummer = 1 Stück, Länge 2.000 mm
INDEX = 1 pc, length 2000 mm

opal
Material: PC

95G5000220



Die zugänglichen Längen: 1000 mm, 2000 mm, 3000 mm, 4000 mm.
Die standardmäßige Toleranz der Länge von Profilen beträgt: +20 mm.
Mehr Informationen >> 1.08.

Available lengths: 1000 mm, 2000 mm, 3000 mm, 4000 mm.
The standard profile length tolerance is +20 mm.
More details >> 1.08.



Achtung! Die Abmessungen des Platzes für die Montage von LED Lichtquelle
Note! Dimensions of the space to install LED source

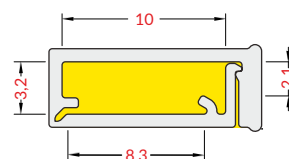

8 mm



Einbauprofile
recessed



ENDKAPPEN / ENDINGS

Endkappe SLASH8
Farben: opal
Material: PMMA
SLASH8 ending
colour: opal
material: PMMA

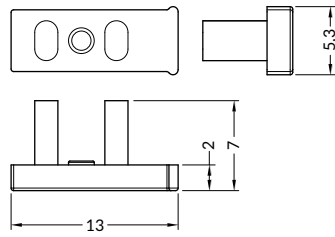

Artikelnummer = 10 Sets = 20 Stück
INDEX = 10 sets = 20 pcs

opal
95G5999922





Das Profil kann verwendet werden, um eine Lichtzeichnung mit geraden Linien oder Bögen zu schaffen.

The profile can be used to create a light drawing using straight lines or arcs.



DEEP10 BC/UX

EINBAUPROFIL MIT DER MÖGLICHKEIT EINE HOMOGENE LICHTLINIE ZU ERREICHEN

A RECESSED PROFILE WHICH CAN GIVE A CONTINUOUS LINE EFFECT

- Anwendung hauptsächlich in Möbel oder in Rigipsplatten
 - eine homogene Lichtlinie (bei LED Streifen mit 120 Leds/m und einer opalen Abdeckung)
 - die winkelförmigen Profilwänden des LED Profils erfüllen die Aufgabe eines Reflektors
 - maximale Breite des LED Streifens 10 mm
-
- mainly used in furniture or plasterboard
 - continuous line of light (when using LED strip 120 P/m and opal cover)
 - angled profile sides are designed for better light reflection
 - maximum LED strip width: 10 mm

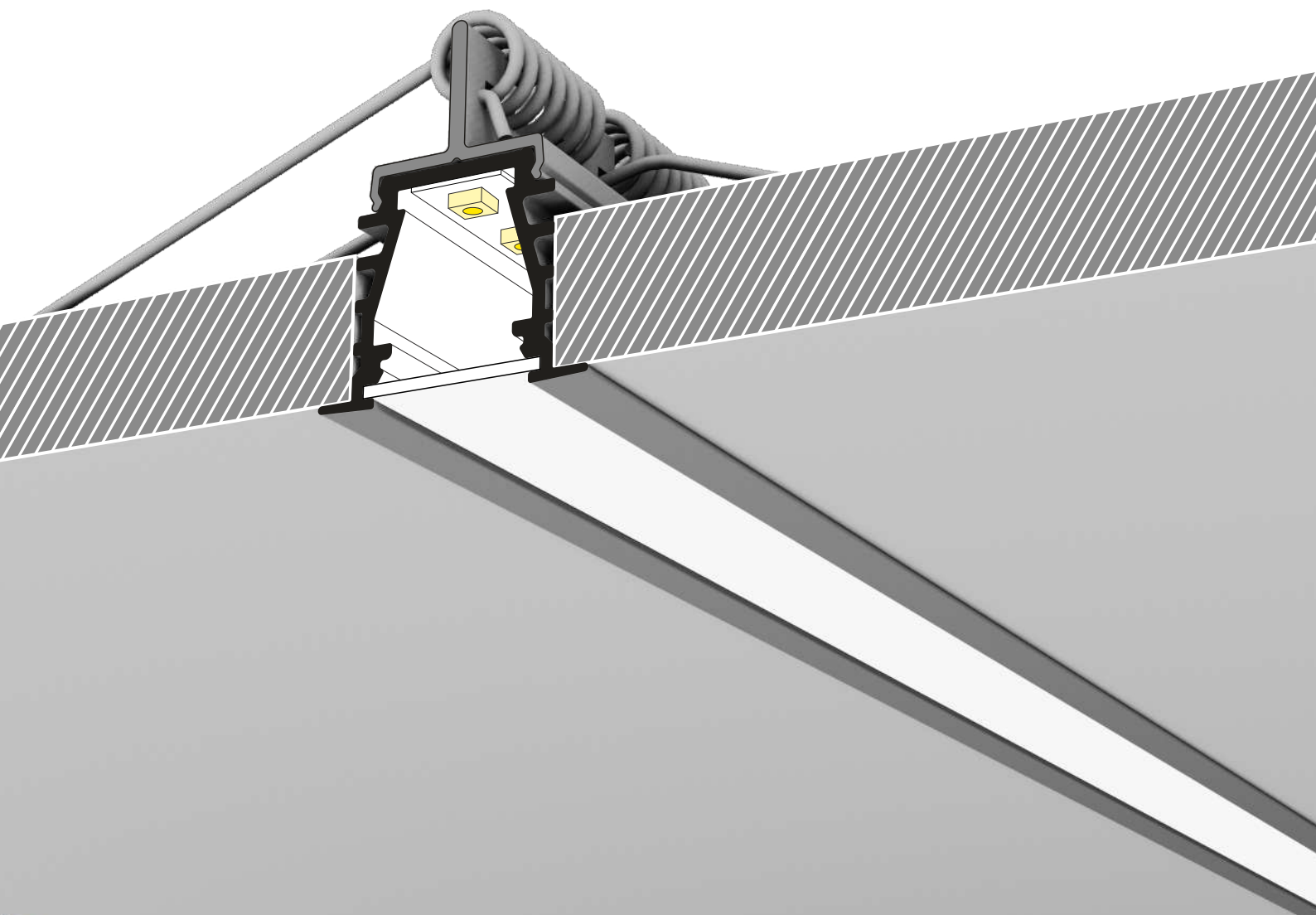

ÄHNLICHES IM ANGEBOT / SIMILAR IN THE OFFER



FLAT8
H/UX



BEGTIN12
J/S



GROOVE10
BC/UX



UNI12
BCD/U



GROOVE14
EF/TY



B Abdeckung **B** einziehbar
B slide cover

C Abdeckung **C** einclipsbar
C click cover

C Abdeckung **C** einclipsbar Linse
C lens cover

U¹ Halter **U** flexibel
U flexible mounting plate

U² Halter **U** flexibel cone
cone U flexible mounting plate

U³ Halter **U** flexibel rack
rack U flexible mounting plate

X¹ Halter **X**
X mounting plate

X² Halter **X** Feder
spring X mounting plate

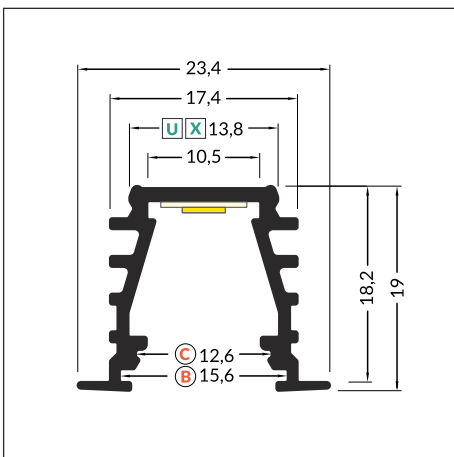
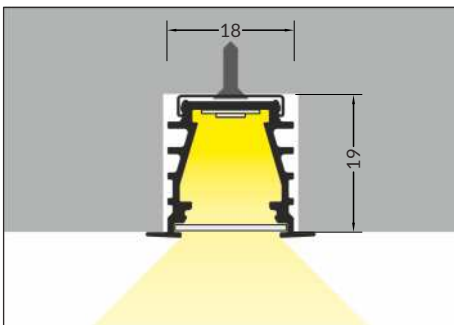
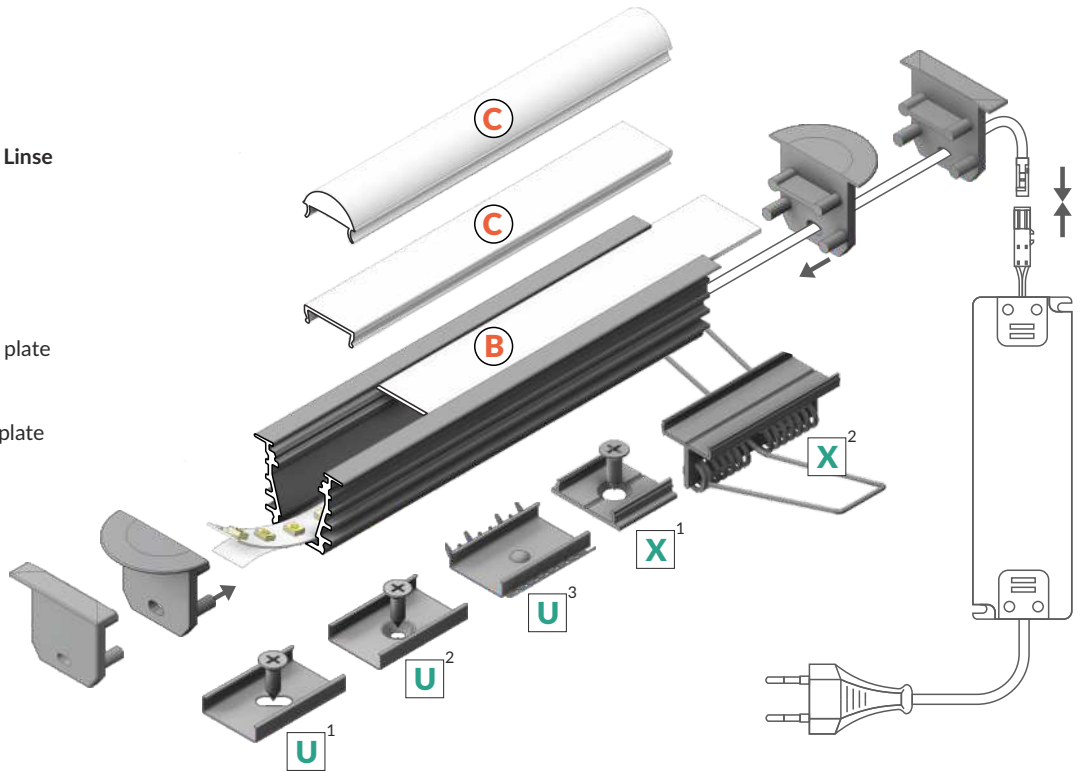

Artikelnummer = 1 Stück, Länge 2.000 mm
INDEX = 1 pc, length 2000 mm

weiß lackiert
white painted
9596030001



eloxiert
anodized
9596030020



schwarz eloxiert
black anodized
9596030021



Rohaluminium
raw aluminium
9596030000



max 10 mm



Einbauprofile
recessed

Die zugänglichen Längen: 1000 mm, 2000 mm, 3000 mm, 4000 mm.
Die standardmäßige Toleranz der Länge von Profilen beträgt: +20 mm.
Mehr Informationen >> 1.08.

Available lengths: 1000 mm, 2000 mm, 3000 mm, 4000 mm.
The standard profile length tolerance is +20 mm.
More details >> 1.08.



ABDECKUNG / COVERS

Abdeckung B einziehbar
Farben: transparent, satiniert, opal
Material: PC, PP, PP

B slide cover
colours: transparent, frosted, opal
material: PC, PP, PP



Achtung! Die Abmessungen des Platzes für die Montage von LED Lichtquelle
Note! Dimensions of the space to install LED source

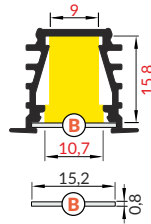

Abdeckung C einclipsbar
Farben: transparent, opal
Material: PMMA

C click cover
colours: transparent, opal
material: PMMA

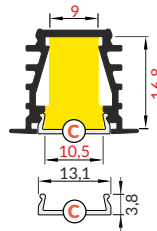

Abdeckung C einclipsbar Linse
Farben: transparent
Material: PC

C lens click cover
colour: transparent
material: PC

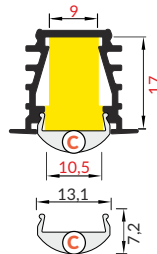

NEU

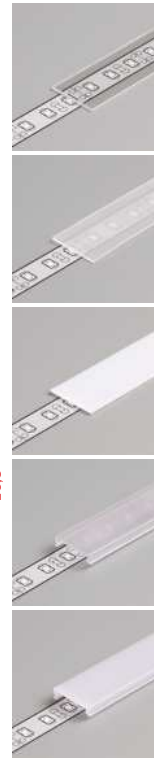

Länge 2.000 mm,
length 2000 mm

B transparent
Artikelnummer = 10 Stück
index = 10 pcs
9576250016

B satiniert / **B** frosted
Artikelnummer = 10 Stück
index = 10 pcs
9576250039

B opal
Artikelnummer = 10 Stück
index = 10 pcs
9576250038

C transparent
Artikelnummer = 1 Stück
index = 1 pc
9576330000

C opal
Artikelnummer = 1 Stück
index = 1 pc
9576330038

Rolle, Länge 20 m,
reel, length 20 m

C opal
Artikelnummer = 1 Stück
index = 1 pc
9576360038S

Länge 2.000 mm,
length 2000 mm

C Linse / **C** lens
Artikelnummer = 1 Stück
index = 1 pc
9576300000

Die Toleranz der Länge von Abdeckungen beträgt: +20 mm.
Mehr Informationen >> 1.08.

The standard cover length tolerance is +20 mm.
More details >> 1.08.

ENDKAPPEN / ENDINGS

Endkappe DEEP10 gen2 mit Öffnung
Farben: weiß, silbern, schwarz, grau
Material: ABS

DEEP10 ending gen2 with hole
colours: white, silver, black, grey
material: ABS

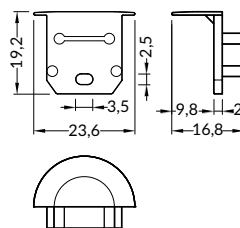

Endkappe DEEP10 gen2 SQ mit Öffnung
Farben: weiß, silbern, schwarz, grau
Material: ABS

DEEP10 ending gen2 SQ with hole
colours: white, silver, black, grey
material: ABS

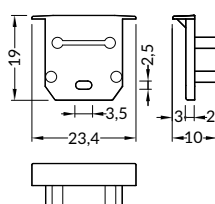

Artikelnummer = 10 Sets = 20 Stück
INDEX = 10 sets = 20 pcs

weiß / white
9596980001
silbern / silver
9596980040
schwarz / black
9596980002
grau / grey
9596980022

weiß / white
9596990001
silbern / silver
9596990040
schwarz / black
9596990002
grau / grey
9596990022



VERBINDUNGSTÜCKE / CONNECTORS

Verbindungsstück X 180 Grad
Farben: Rohaluminium
Material: Aluminium

X connector 180 deg
colour: raw aluminium
material: aluminium

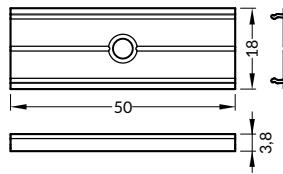

Artikelnummer = 1 Set
INDEX = 1 set

Rohaluminium
raw aluminium
9576350000

HALTER / MOUNTINGS

Halter U flexibel
Farben: inox
Material: rostfreier Stahl

U flexible mounting plate
colour: inox
material: stainless steel

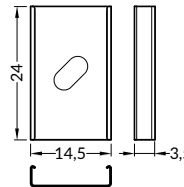

Artikelnummer = 10 Sets = 20 Stück
INDEX = 10 sets = 20 pcs

inox
9576380000

Halter U flexibel cone
Farben: inox
Material: rostfreier Stahl

cone U flexible mounting plate
colour: inox
material: stainless steel

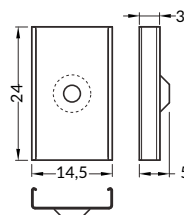

inox
9576620000

Halter U flexibel rack
Farben: inox
Material: rostfreier Stahl

rack U flexible mounting plate
colour: inox
material: stainless steel

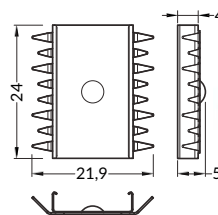

inox
9576610019

Halter X
Farben: Rohaluminium
Material: Aluminium

X mounting plate
colour: raw aluminium
material: aluminium

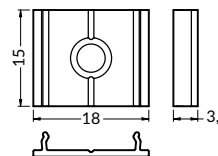

Rohaluminium
raw aluminium
9576260000

Halter X Feder
Farben: Rohaluminium
Material: Aluminium

spring X mounting plate
colour: raw aluminium
material: aluminium

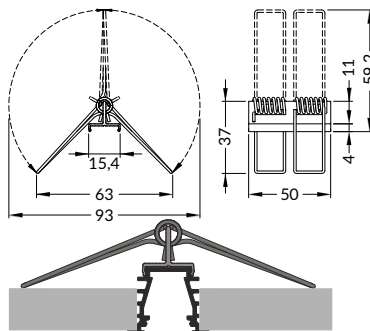

Artikelnummer = 1 Stück
INDEX = 1 pc

Rohaluminium
raw aluminium
9523130000



GROOVE10 BC/UX

EIN ALUMINIUMPROFIL FÜR EINBAU

RECESSED ALUMINIUM PROFILE

- hauptsächlich für Möbelbereich
- möglich ist auch die Anwendung an der Decke
- 6 Abdeckungen zur Wahl
- maximale Breite des LED Streifens 10 mm

- used mainly in furniture
- ceiling installation possible
- 6 types of covers
- maximum LED strip width: 10 mm



ÄHNLICHES IM ANGEBOT / SIMILAR IN THE OFFER



DEEP10
BC/UX



TRIO10
BC



BEGTIN12
J/S



UNI12
BCD/U



GROOVE14
EF/TY



- B** Abdeckung **B** einziehbar
B slide cover
- C** Abdeckung **C** einclipsbar
C click cover
- C** Abdeckung **C** einclipsbar Linse
C lens cover
- U**¹ Halter **U** flexibel
U flexible mounting plate
- U**² Halter **U** flexibel cone
cone U flexible mounting plate
- U**³ Halter **U** flexibel rack
rack U flexible mounting plate
- X**¹ Halter **X**
X mounting plate
- X**² Halter **X** Feder
spring X mounting plate

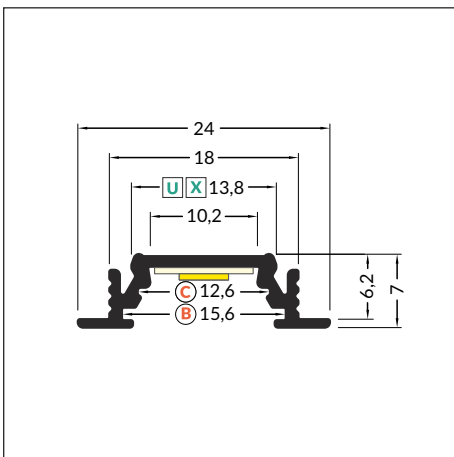
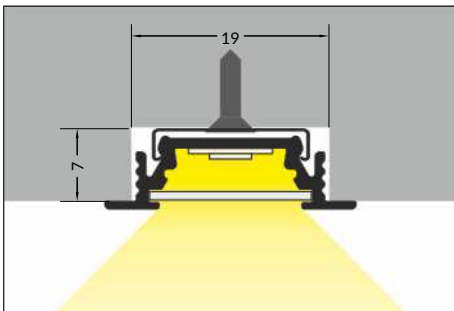
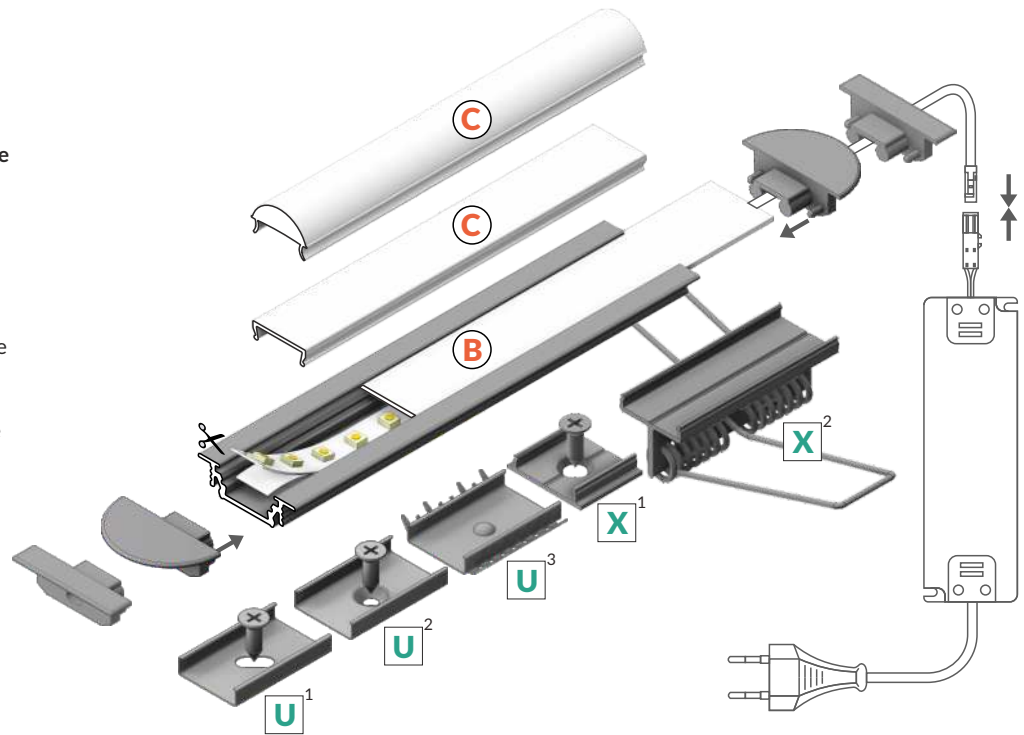

Artikelnummer = 1 Stück, Länge 2.000 mm
INDEX = 1 pc, length 2000 mm

weiß lackiert
white painted
9576210001



eloxiert
anodized
9576210020



schwarz eloxiert
black anodized
9576210021

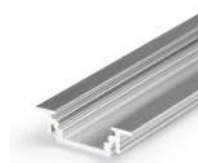

Rohaluminium
raw aluminium
9576210000

Die zugänglichen Längen: 1000 mm, 2000 mm, 3000 mm, 4000 mm.
Die standardmäßige Toleranz der Länge von Profilen beträgt: +20 mm.
Mehr Informationen >> 1.08.

Available lengths: 1000 mm, 2000 mm, 3000 mm, 4000 mm.
The standard profile length tolerance is +20 mm.
More details >> 1.08.



max 10 mm



Einbauprofile
recessed



ABDECKUNG / COVERS

Abdeckung B einschiebbar
Farben: transparent, satiniert, opal
Material: PC, PP, PP

B slide cover
colours: transparent, frosted, opal
material: PC, PP, PP

Abdeckung C einclipsbar
Farben: transparent, opal
Material: PMMA

C click cover
colours: transparent, opal
material: PMMA

Abdeckung C einclipsbar Linse
Farben: transparent
Material: PC

C click cover lens
colour: transparent
material: PC



Achtung! Die Abmessungen des Platzes für die Montage von LED Lichtquelle
Note! Dimensions of the space to install LED source

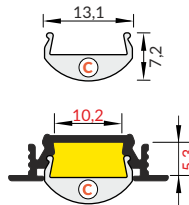
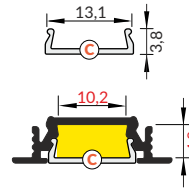
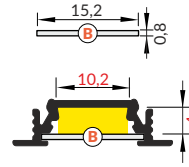

Länge 2.000 mm,
length 2000 mm

B transparent
Artikelnummer = 10 Stück
index = 10 pcs
9576250016

B satiniert / B frosted
Artikelnummer = 10 Stück
index = 10 pcs
9576250039

B opal
Artikelnummer = 10 Stück
index = 10 pcs
9576250038

C transparent
Artikelnummer = 1 Stück
index = 1 pc
9576330000

C opal
Artikelnummer = 1 Stück
index = 1 pc
9576330038

NEU



Rolle, Länge 20 m,
reel, length 20 m

C opal
Artikelnummer = 1 Stück
index = 1 pc
9576360038S



Länge 2.000 mm,
length 2000 mm

C Linse / C lens
Artikelnummer = 1 Stück
index = 1 pc
9576300000

Die Toleranz der Länge von Abdeckungen beträgt: +20 mm.
Mehr Informationen >> 1.08.
The standard cover length tolerance is +20 mm.
More details >> 1.08.

HALTER / MOUNTINGS

Halter U flexibel
Farben: inox
Material: rostfreier Stahl

U flexible mounting plate
colour: inox
material: stainless steel

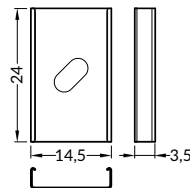
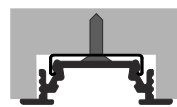

Halter U flexibel cone
Farben: inox
Material: rostfreier Stahl

cone **U** flexible mounting plate
colour: inox
material: stainless steel

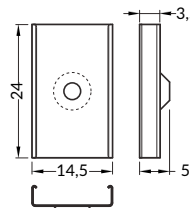
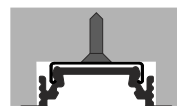

Halter U flexibel rack
Farben: inox
Material: rostfreier Stahl

rack **U** flexible mounting plate
colour: inox
material: stainless steel

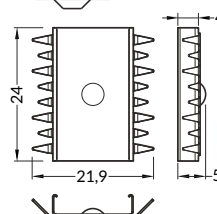

Artikelnummer = 10 Sets = 20 Stück
INDEX = 10 sets = 20 pcs

inox
9576380000

inox
9576620000

inox
9576610019



HALTER / MOUNTINGS

Halter X
Farben: Rohaluminium
Material: Aluminium

X mounting plate
colours: raw aluminium
material: aluminium

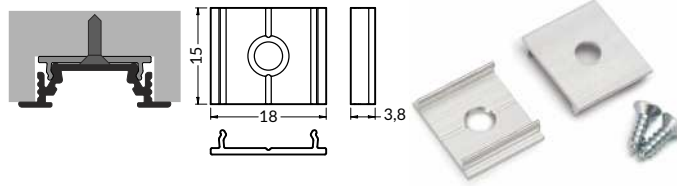

Artikelnummer = 10 Sets = 20 Stück
INDEX = 10 sets = 20 pcs

Rohaluminium
raw aluminium
9576260000

Halter X Feder
Farben: Rohaluminium
Material: Aluminium

spring X mounting plate
colours: raw aluminium
material: aluminium

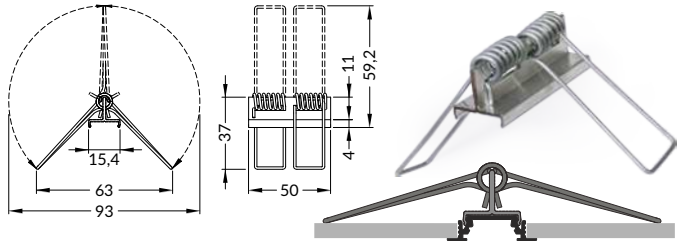

Artikelnummer = 1 Stück
INDEX = 1 pc

Rohaluminium
raw aluminium
9523130000

ENDKAPPEN / ENDINGS

Endkappe GROOVE10 gen2 mit Öffnung
Farben: weiß, silbern, schwarz, grau
Material: ABS

endings GROOVE10 gen2 with hole
colours: white, silver, black, grey
material: ABS

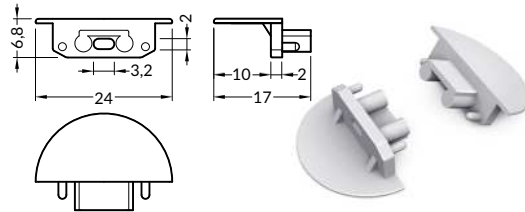

Artikelnummer = 10 Sets = 20 Stück
INDEX = 10 sets = 20 pcs

weiß / white
9576980001
silbern / silver
9576980040
schwarz / black
9576980002
grau / grey
9576980022

Endkappe GROOVE10 gen2 SQ mit Öffnung
Farben: weiß, silbern, schwarz, grau
Material: ABS

endings GROOVE10 gen2 SQ with hole
colours: white, silver, black, grey
material: ABS

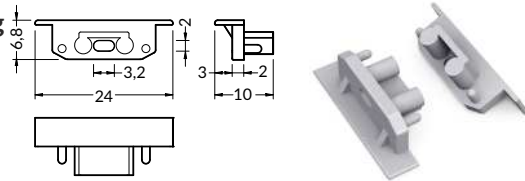

weiß / white
9576990001
silbern / silver
9576990040
schwarz / black
9576990002
grau / grey
9576990022

VERBINDUNGSSTÜCKE / CONNECTORS

Verbindungsstück X 180 Grad
Farben: Rohaluminium
Material: Aluminium

X connector 180 deg
colour: raw aluminium
material: aluminium

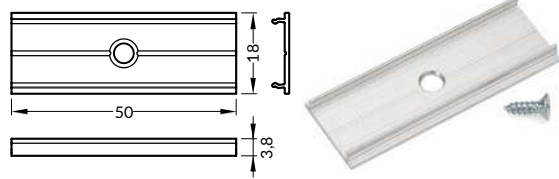

Artikelnummer = 1 Set
INDEX = 1 set

Rohaluminium
raw aluminium
9576350000

Verbinder 90 Grad für GROOVE10
Farben: weiß, eloxiert, schwarz
Material: Aluminium

GROOVE10 connector 90 deg
colours: white, anodized, black
material: aluminium

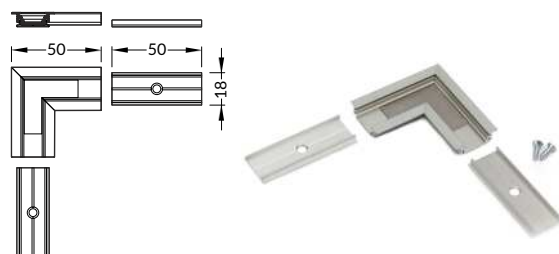

weiß lackiert
white painted
9576530001
eloxiert
anodized
9576530020
schwarz eloxiert
black anodized
9576530021



EINE HOMOGENE LICHTLINIE IN EINEM KLEINEN EINBAUPROFIL

CONTINUOUS LIGHT LINE IN SMALL RECESSED PROFILE

- für die Anwendung in einer Rigipsplatte - ohne in die Konstruktion der Platte einzugreifen
- auch für die Anwendung in Möbel
- eine homogene Lichtlinie (bei LED Streifen mit 120 leds/m und einer opalen Abdeckung)
- Sockel mit Slick Funktion
- kleine Maße
- maximale Breite des LED Streifens 10 mm

- suitable for use in plasterboards - does not affect the structure of the board
- used also in furniture
- continuous line of light (when using LED strip 120 P/m and opal cover)
- SLICK socket
- miniature dimensions
- maximum width of LED strip: 10 mm



ÄHNLICHES IM ANGEBOT / SIMILAR IN THE OFFER



DEEP10
BC/UX



SMART10
AC2/Z



GROOVE10
BC/UX



BEGTIN12
J/S



UNI12
BCD/U



GROOVE14
EF/TY



- A** Abdeckung A einschiebbar
A slide cover
- C2** Abdeckung C2 einclipsbar
C2 click cover
- Z¹** Halter Z flexibel
Z flexible mounting plate
- Z²** Halter Z flexibel cone
cone Z flexible mounting plate

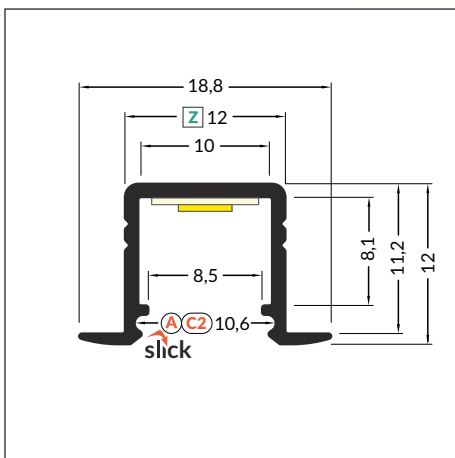
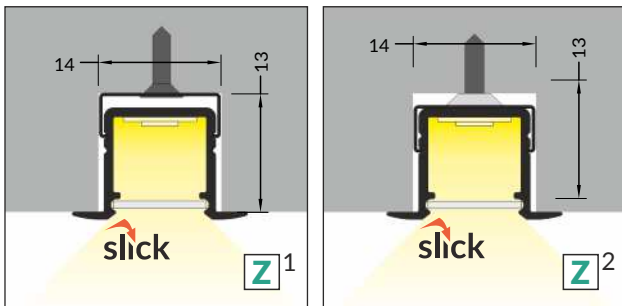
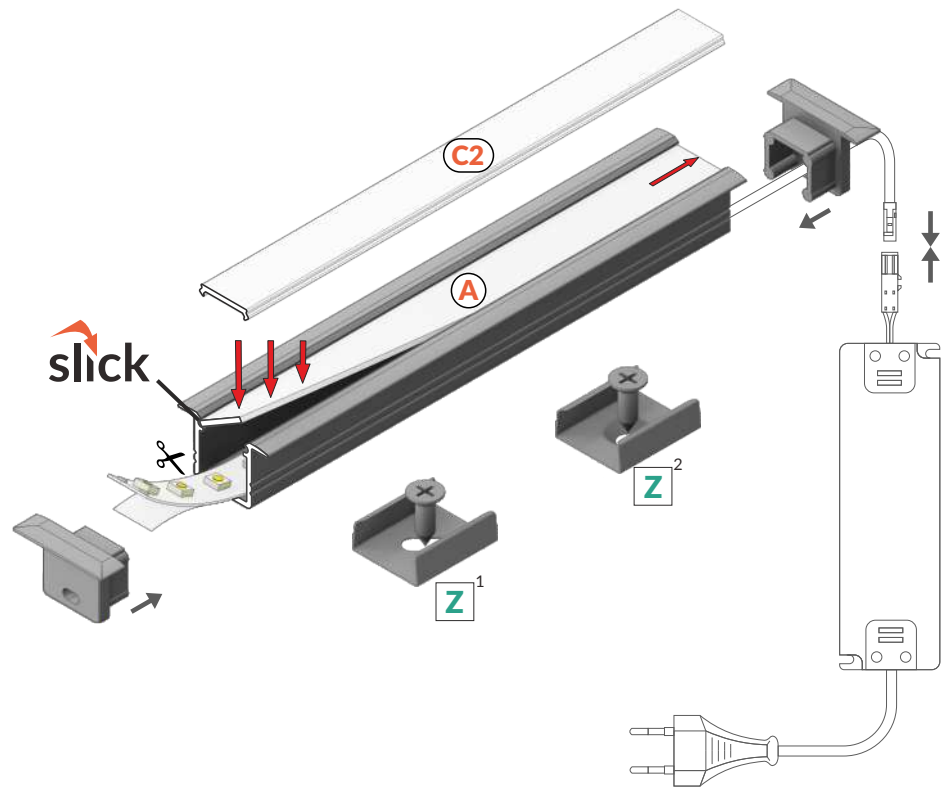

Artikelnummer = 1 Stück, Länge 2.000 mm
INDEX = 1 pc, length 2000 mm

weiß lackiert
white painted
95E3020001

eloxiert
anodized
95E3020020

schwarz eloxiert
black anodized
95E3020021

Rohaluminium
raw aluminium
95E3020000

Die zugänglichen Längen: 1000 mm, 2000 mm, 3000 mm, 4000 mm.
Die standardmäßige Toleranz der Länge von Profilen beträgt: +20 mm.
Mehr Informationen >> 1.08.

Available lengths: 1000 mm, 2000 mm, 3000 mm, 4000 mm.
The standard profile length tolerance is +20 mm.
More details >> 1.08.



ABDECKUNG / COVERS

Abdeckung **A** einziehbar
Farben: transparent, satiniert, opal
Material: PC, PP, PP

A slide cover
colours: transparent, frosted, opal
material: PC, PP, PP



Achtung! Die Abmessungen des Platzes für die Montage von LED Lichtquelle
Note! Dimensions of the space to install LED source

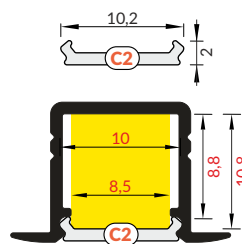
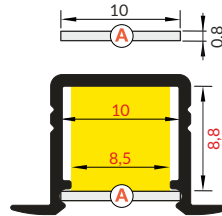

Länge 2.000 mm,
length 2000 mm

A transparent
Artikelnummer = 10 Stück
index = 10 pcs

9589070016

A satiniert / A frosted
Artikelnummer = 10 Stück
index = 10 pcs

9589070039

A opal
Artikelnummer = 10 Stück
index = 10 pcs

9589070038

C2 transparent
Artikelnummer = 1 Stück
index = 1 pc

9589000216

C2 opal
Artikelnummer = 1 Stück
index = 1 pc

9589000238

Die Toleranz der Länge von Abdeckungen beträgt: +20 mm.
Mehr Informationen >> 1.08.
The standard cover length tolerance is +20 mm.
More details >> 1.08.

Abdeckung **C2** einclipsbar
Farben: transparent, opal
Material: PMMA

NEU

C2 click cover
colours: transparent, opal
material: PMMA

ENDKAPPEN / ENDINGS

Endkappe SMART-IN10 mit Öffnung
Farben: weiß, silbern, schwarz, grau
Material: ABS

SMART-IN10 ending with hole
colours: white, silver, black, grey
material: ABS

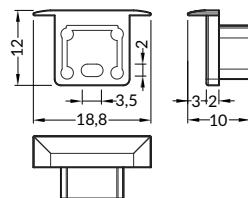

Artikelnummer = 10 Sets = 20 Stück
INDEX = 10 sets = 20 pcs

weiß / white
95E3990001

silbern / silver
95E3990040

schwarz / black
95E3990002

grau / grey
95E3990022

HALTER / MOUNTINGS

Halter **Z** flexibel
Farben: weiß, inox, schwarz
Material: rostfreier Stahl

Z flexible mounting plate
colours: white, inox, black
material: stainless steel

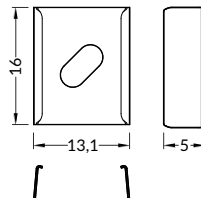
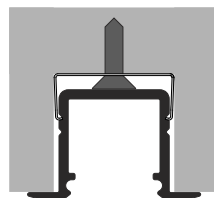

Artikelnummer = 10 Sets = 20 Stück
INDEX = 10 sets = 20 pcs

weiß / white
9589270001

inox
9589270019

schwarz / black
9589270002

Halter **Z** flexibel cone
Farben: weiß, inox, schwarz
Material: rostfreier Stahl

cone **Z** flexible mounting plate
colours: white, inox, black
material: stainless steel

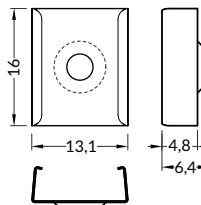
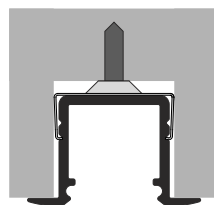

weiß / white
9589980001

inox
9589980019

schwarz / black
9589980002



EIN KLEINES ALUMINIUMPROFIL FÜR EINBAU

SMALL RECESSED ALUMINIUM PROFILE

- ein leichtes Budget-Profil
- hauptsächlich für die Anwendung in Möbel
- Sockel mit Slick Funktion
- maximale Breite des LED Streifens 12 mm

- light weight, budget profile
- used mainly in furniture
- Slick socket
- maximum LED strip width: 12 mm



ÄHNLICHES IM ANGEBOT / SIMILAR IN THE OFFER



DEEP10
BC/UX



GROOVE10
BC/UX



SMART-IN10
AC2/Z



BEGTIN12
J/S



J Abdeckung **J** einziehbar
J slide cover

S¹ Halter **S** flexibel
S flexible mounting plate

S² Halter **S** flexibel cone
 cone **S** flexible mounting plate

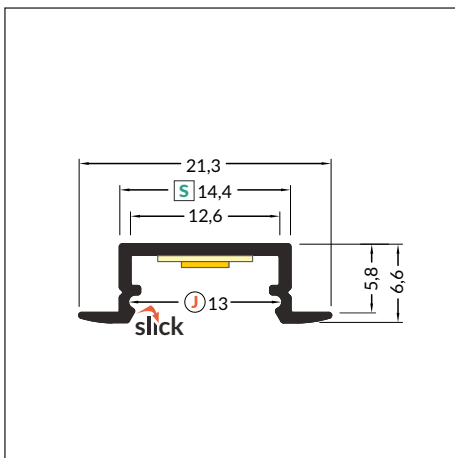
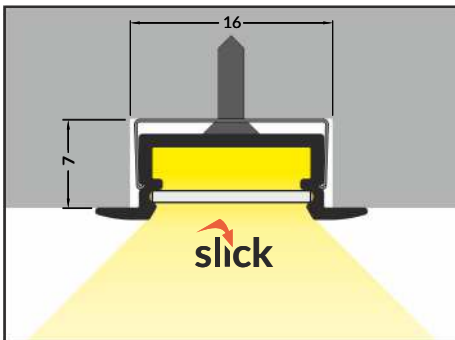
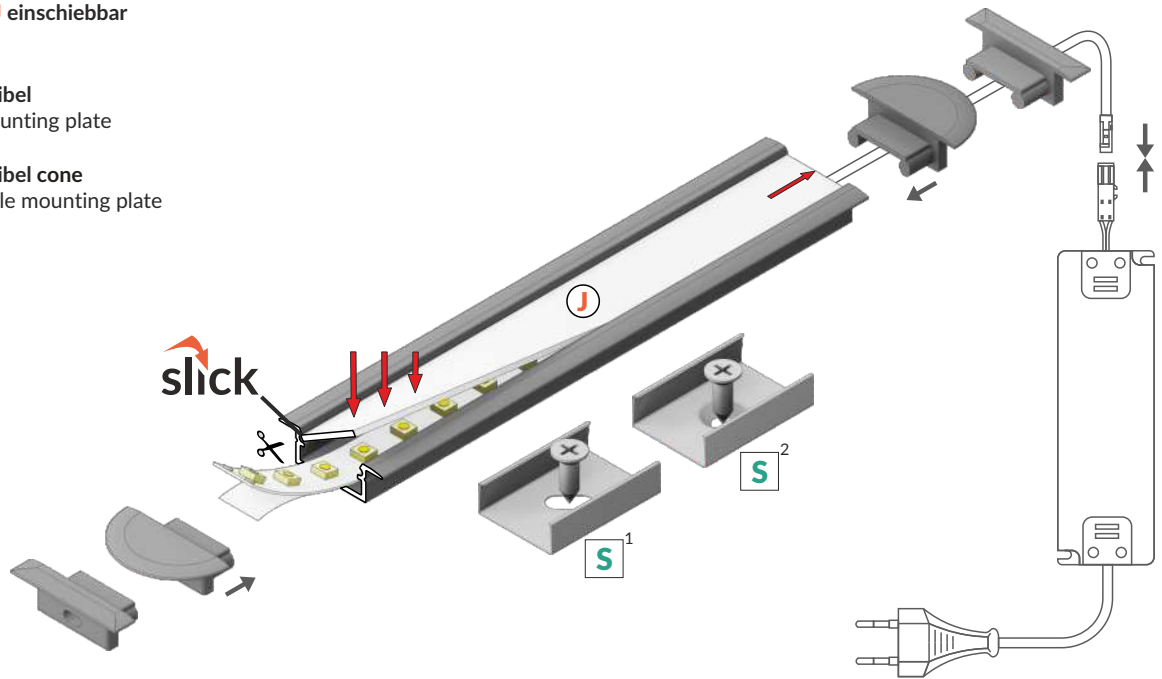

 max 12 mm

 Einbauprofile
 recessed



Artikelnummer = 1 Stück, Länge 2.000 mm
 INDEX = 1 pc, length 2000 mm

weiß lackiert
 white painted
95C8020001



eloxiert
 anodized
95C8020020



schwarz eloxiert
 black anodized
95C8020021



Rohaluminium
 raw aluminium
95C8020000

Die zugänglichen Längen: 1000 mm, 2000 mm, 3000 mm, 4000 mm.
 Die standardmäßige Toleranz der Länge von Profilen beträgt: +20 mm.
 Mehr Informationen >> 1.08.

Available lengths: 1000 mm, 2000 mm, 3000 mm, 4000 mm.
 The standard profile length tolerance is +20 mm.
 More details >> 1.08.



ABDECKUNG / COVERS

Abdeckung **J** einziehbar
Farben: transparent, satiniert, opal
Material: PC, PP, PP

J slide cover
colours: transparent, frosted, opal
material: PC, PP, PP



Achtung! Die Abmessungen des Platzes für die Montage von LED Lichtquelle
Note! Dimensions of the space to install LED source

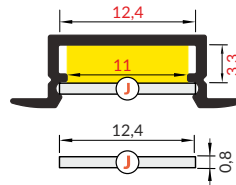

Länge 2.000 mm,
length 2000 mm

B transparent
Artikelnummer = 10 Stück
index = 10 pcs

9570330016

B satiniert / **B** frosted
Artikelnummer = 10 Stück
index = 10 pcs

9570330039

B opal
Artikelnummer = 10 Stück
index = 10 pcs

9570330038

Die Toleranz der Länge von Abdeckungen beträgt: +20 mm.
Mehr Informationen >> 1.08.

The standard cover length tolerance is +20 mm.
More details >> 1.08.

ENDKAPPEN / ENDINGS

Endkappe **BEGTIN12 gen2** mit Öffnung
Farben: weiß, silbern, schwarz, grau
Material: ABS

BEGTIN12 ending gen2 with hole
colours: white, silver, black, grey
material: ABS

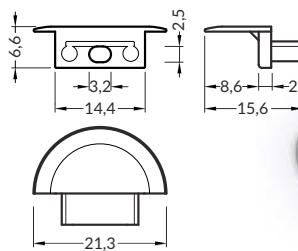

Artikelnummer = 10 Sets = 20 Stück
INDEX = 10 sets = 20 pcs

weiß / white
95C8980001

silbern / silver
95C8980040

schwarz / black
95C8980002

grau / grey
95C8980022

Endkappe **BEGTIN12 gen2 SQ** mit Öffnung
Farben: weiß, silbern, schwarz, grau
Material: ABS

BEGTIN12 ending gen2 SQ with hole
colours: white, silver, black, grey
material: ABS

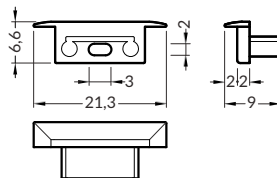

weiß / white
95C8970001

silbern / silver
95C8970040

schwarz / black
95C8970002

grau / grey
95C8970022

HALTER / MOUNTINGS

Halter **S** flexibel
Farben: weiß, inox, schwarz
Material: rostfreier Stahl

S flexible mounting plate
colours: white, inox, black
material: stainless steel

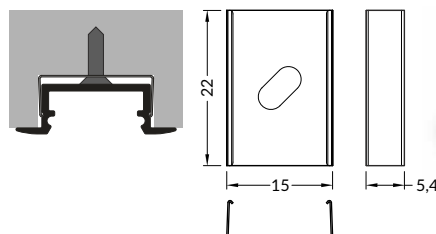

weiß / white
95C7980001

inox
95C7980019

schwarz / black
95C7980002

Halter **S** flexibel cone
Farben: weiß, inox, schwarz
Material: rostfreier Stahl

cone **S** flexible mounting plate
colours: white, inox, black
material: stainless steel

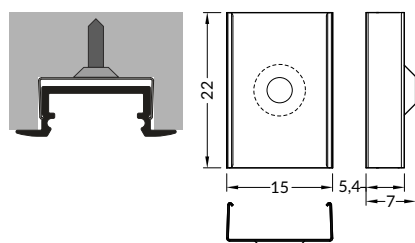

weiß / white
95C7950001

inox
95C7950019

schwarz / black
95C7950002



FLOOR K

EINBAUPROFILE FÜR FUSSBÖDEN

RECESSED FLOOR PROFILES

- eine hohe Beständigkeit gegen Abwischbarkeit, eine feste Abdeckung
- das Erreichen von Wasserbeständigkeit ist möglich
- bei einer erhöhten Feuchtigkeit soll man einen wasserdichten LED Streifen verwenden

- high abrasion resistance, resistant cover
- possibility of waterproof
- with high humidity, please use waterproof tape



ÄHNLICHES IM ANGEBOT / SIMILAR IN THE OFFER



STEP10
C



DEEP10
BC/UX



UNI12
BCD/U



UNI-TILE12
90 deg C



UNI-TILE12
180 deg C

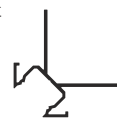

UNI-TILE12
270 deg C



FLOOR8 K

NEU

Optimale Höhe
für den Einbau
in Standardfliesen
oder Fussbodenpanelen > 3.31

Optimal height
for installation
in standard tiles
or floor panels > 3.31



max 8 mm



für homogene Lichtlinie
for continuous
line of light

FLOOR12 K/U

Die ideale Lösung
zur Verwendung
in dickeren
Fussbodenmaterialien > 3.33

The perfect solution
for application
in thicker floor
materials > 3.33



max 12 mm



für homogene Lichtlinie
for continuous
line of light

K Abdeckung K einclipsbar
K click cover

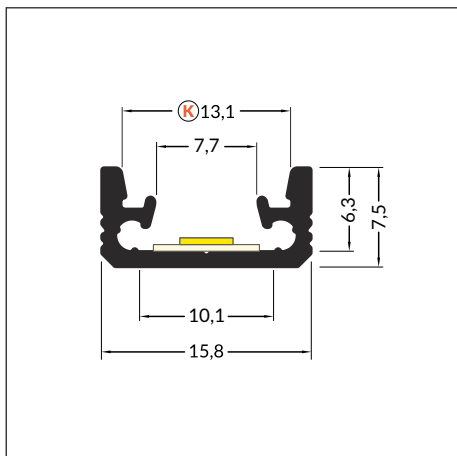
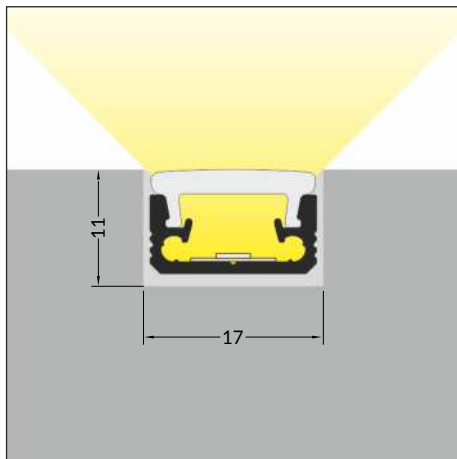
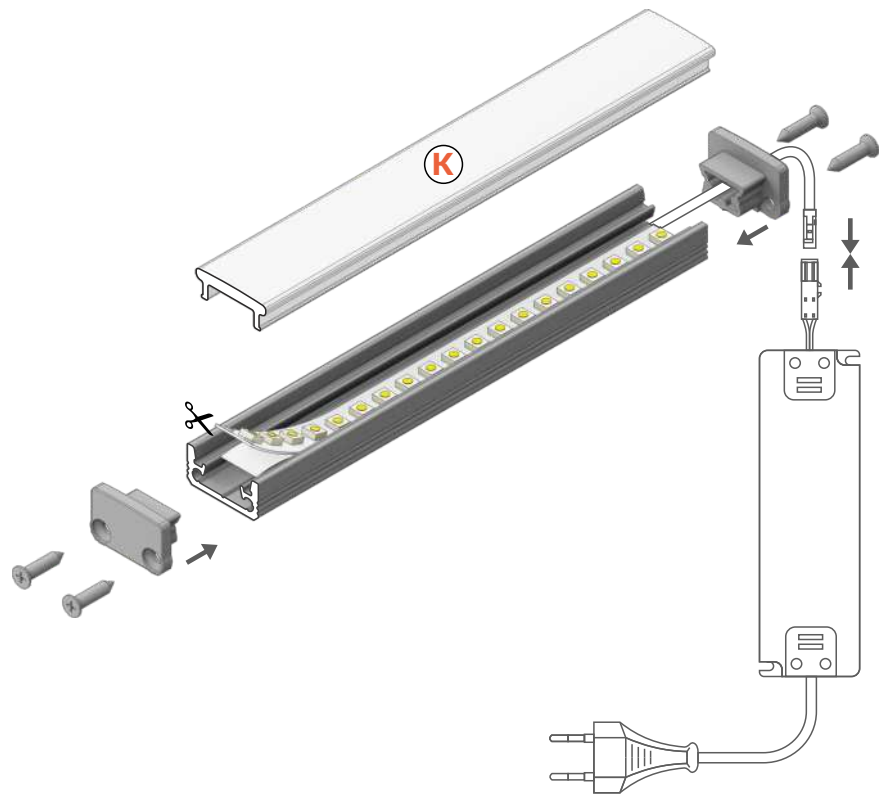

Artikelnummer = 1 Stück, Länge 2.000 mm
INDEX = 1 pc, length 2000 mm



eloxiert
anodized
95G6000220

Die zugänglichen Längen: 1000 mm, 2000 mm, 3000 mm, 4000 mm.
Die standardmäßige Toleranz der Länge von Profilen beträgt: +20 mm.
Mehr Informationen >> 1.08.

Available lengths: 1000 mm, 2000 mm, 3000 mm, 4000 mm.
The standard profile length tolerance is +20 mm.
More details >> 1.08.



max 8 mm



Einbauprofile
recessed



IK08 (5 J)



↓ 5 J





ABDECKUNG / COVERS

Abdeckung **K** einclipsbar

Farben: opal
Material: PC

K click cover
colour: opal
material: PC



Achtung! Die Abmessungen des Platzes für die Montage von LED Lichtquelle
Note! Dimensions of the space to install LED source

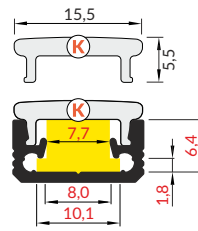

Länge 2.000 mm,
length 2000 mm

K opal
Artikelnummer = 1 Stück
index = 1 pc

95B1040038

Die Toleranz der Länge von Abdeckungen beträgt: +20 mm.
Mehr Informationen >> 1.08.
The standard cover length tolerance is +20 mm.
More details >> 1.08.

ENDKAPPEN / ENDINGS

Endkappe FLOOR8

Farben: silbern, grau
Material: ABS

FLOOR8 ending
colours: silver, grey
material: ABS

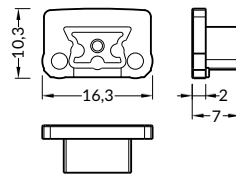

Artikelnummer = 10 Sets = 20 Stück
INDEX = 10 sets = 20 pcs

silbern / silver
95G6999940

grau / grey
95G6999922

DICHTUNGSSET / SEALING

Dichtungsringe für Endkappe FLOOR8

2x Silikondichtung
4x Dichtungsring

sealings for FLOOR8 endings
2x silicone sealings
4x rubber o-ring



bei erhöhter Feuchtigkeit
empfehlen wir ein Abdichtungsset
und ein wasserdichtes
LED Streifen zu verwenden
In high humidity conditions
use waterproof tape and silicone seal



Artikelnummer = 1 Set
INDEX = 1 set

95G69998005





- K** Abdeckung K einclipsbar
K click cover
- U¹** Halter U flexibel
U flexible mounting plate
- U²** Halter U flexibel cone
cone U flexible mounting plate

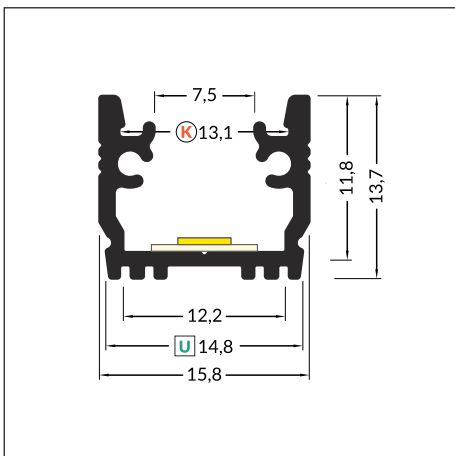
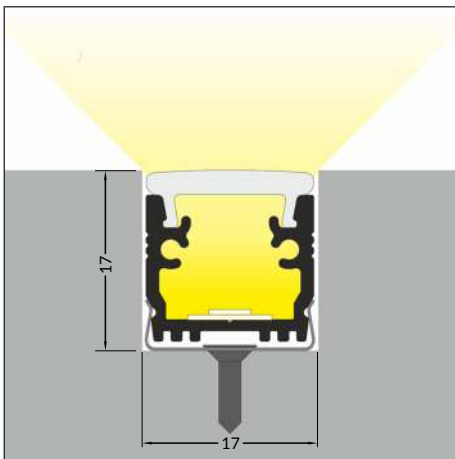
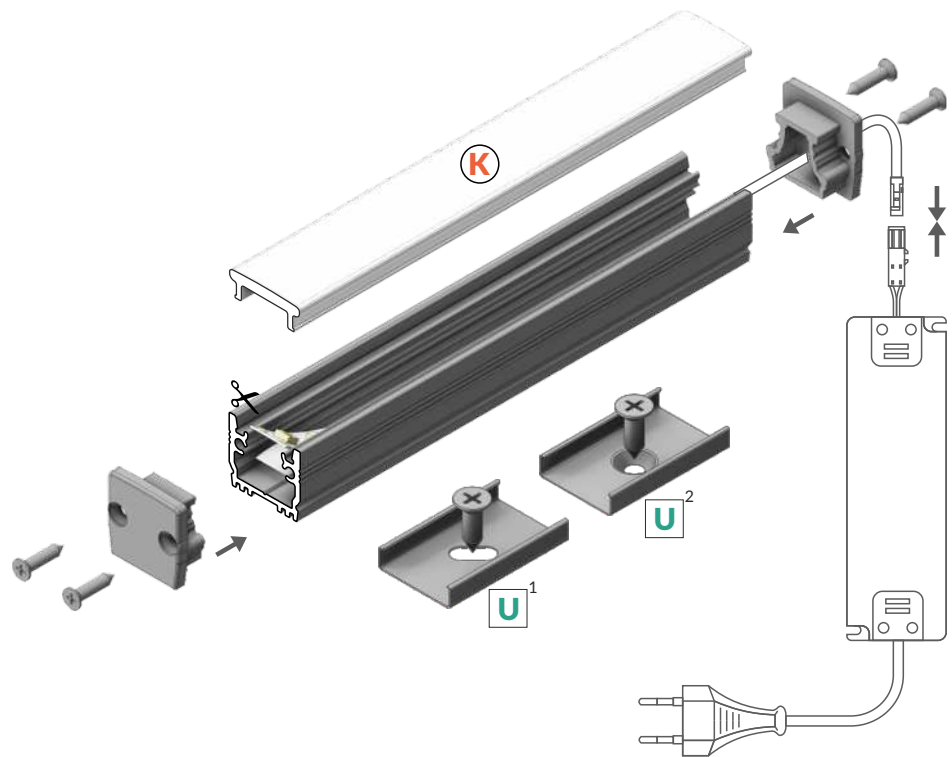

Artikelnummer = 1 Stück, Länge 2.000 mm
INDEX = 1 pc, length 2000 mm



eloxiert
anodized
95B1020020

Die zugänglichen Längen: 1000 mm, 2000 mm, 3000 mm, 4000 mm.
Die standardmäßige Toleranz der Länge von Profilen beträgt: +20 mm.
Mehr Informationen >> 1.08.

Available lengths: 1000 mm, 2000 mm, 3000 mm, 4000 mm.
The standard profile length tolerance is +20 mm.
More details >> 1.08.



max 12 mm



Einbauprofile
recessed



IK08 (5 J)



↓ 5 J

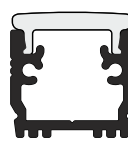



ABDECKUNG / COVERS

Abdeckung **K** einclipbar
Farben: opal
Material: PC

K click cover
colour: opal
material: PC



Achtung! Die Abmessungen des Platzes für die Montage von LED Lichtquelle
Note! Dimensions of the space to install LED source

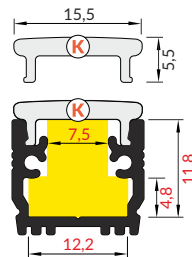

Länge 2.000 mm,
length 2000 mm

K opal
Artikelnummer = 1 Stück
index = 1 pc
95B1040038

Die Toleranz der Länge von Abdeckungen beträgt: +20 mm.
Mehr Informationen >> 1.08.
The standard cover length tolerance is +20 mm.
More details >> 1.08.

ENDKAPPEN / ENDINGS

Endkappe **FLOOR12**
Farben: silbern, grau
Material: ABS

FLOOR12 ending
colours: silver, grey
material: ABS

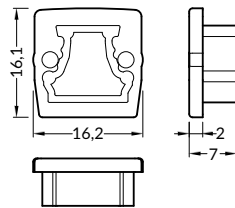

Artikelnummer = 10 Sets = 20 Stück
INDEX = 10 sets = 20 pcs

silbern / silver
95B1940040

grau / grey
95B1940022

Endkappe **FLOOR12 mit Öffnung**
Farben: silbern, grau
Material: ABS

FLOOR12 ending with hole
colours: silver, grey
material: ABS

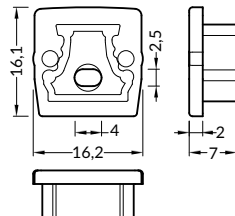

silbern / silver
95B1960040

grau / grey
95B1960022

HALTER / MOUNTINGS

Halter **U** flexibel
Farben: inox
Material: rostfreier Stahl

U flexible mounting plate
colour: inox
material: stainless steel

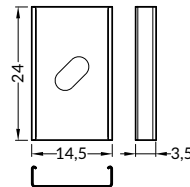
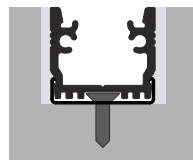

Artikelnummer = 10 Sets = 20 Stück
INDEX = 10 sets = 20 pcs

inox
9576380000

Halter **U** flexibel cone
Farben: inox
Material: rostfreier Stahl

cone **U** flexible mounting plate
colour: inox
material: stainless steel

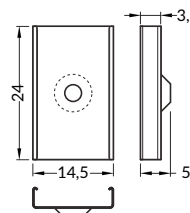
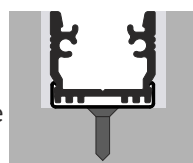

inox
9576620000

DICHTUNGSSET / SEALING

Dichtungsringe für Endkappe **FLOOR12**
2x Silikondichtung
4x Dichtungsring

sealings for FLOOR12 endings
2x silicone sealings
4x rubber o-ring



bei erhöhter Feuchtigkeit empfehlen wir ein Abdichtungsset und ein wasserdichtes LED Streifen zu verwenden
In high humidity conditions use waterproof tape and silicone seal



Artikelnummer = 1 Set
INDEX = 1 set

95B1830000

GROOVE14 EF/TY

EIN GRUNDLEGENDES EINBAUALUMINIUMPROFIL

BASIC ALUMINIUM RECESSED PROFILE

- hauptsächlich für Möbelbereich
- maximale Breite des LED Streifens 14 mm

- used mainly in furniture
- maximum LED strip width: 14 mm



ÄHNLICHES IM ANGEBOT / SIMILAR IN THE OFFER



DEEP10
BC/UX



GROOVE10
BC/UX



TRIO10
BC



UNI12
BCD/U



E Abdeckung E einschiebbar
E slide cover

F Abdeckung F einclipsbar
F click cover

E7 Abdeckung E7 einclipsbar
E7 click cover

Y¹ Halter Y flexibel
Y flexible mounting plate

Y² Halter Y flexibel cone
cone Y flexible mounting plate

T Halter T
T mounting plate

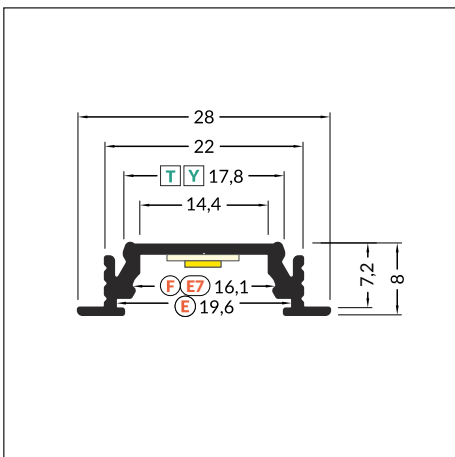
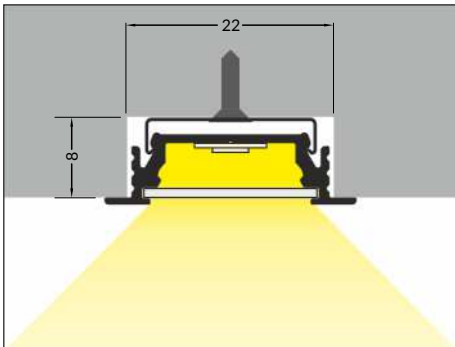
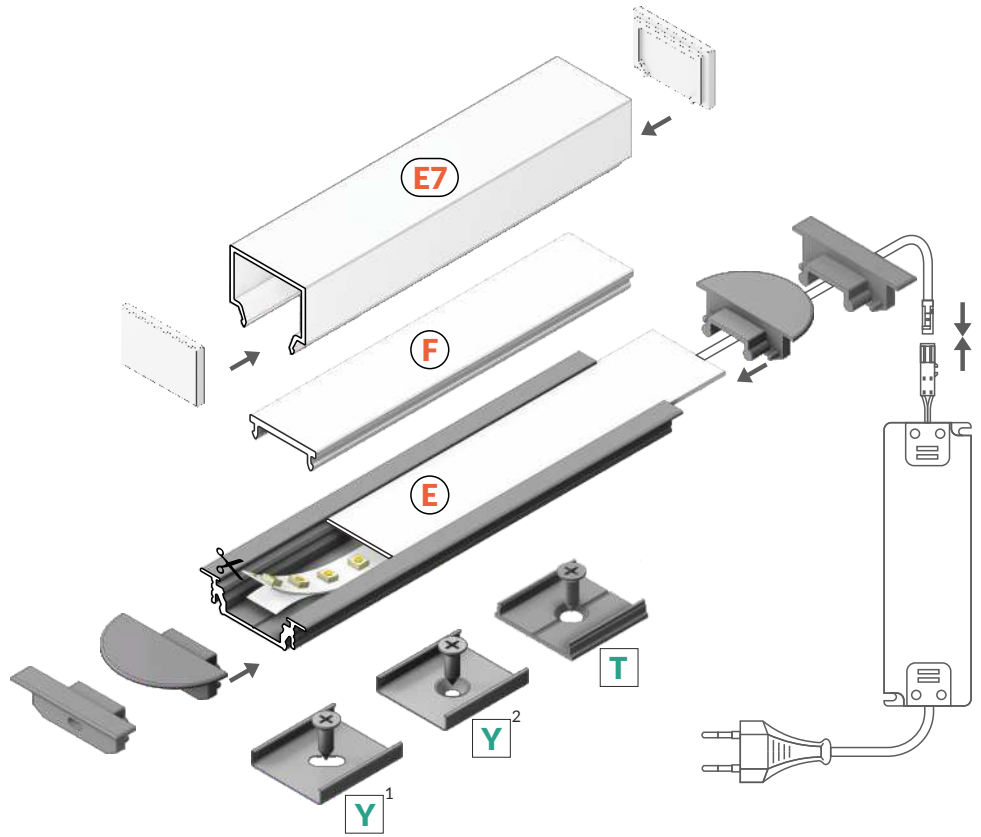

 max 14 mm

 Einbauprofile
recessed



Artikelnummer = 1 Stück, Länge 2.000 mm
INDEX = 1 pc, length 2000 mm

weiß lackiert
white painted
95A3020001



eloxiert
anodized
95A3020020



schwarz eloxiert
black anodized
95A3020021



Rohaluminium
raw aluminium
95A3020000

Die zugänglichen Längen: 1000 mm, 2000 mm, 3000 mm, 4000 mm.
Die standardmäßige Toleranz der Länge von Profilen beträgt: +20 mm.
Mehr Informationen >> 1.08.

Available lengths: 1000 mm, 2000 mm, 3000 mm, 4000 mm.
The standard profile length tolerance is +20 mm.
More details >> 1.08.



ABDECKUNG / COVERS

Abdeckung E einziehbar
Farben: transparent, satiniert, opal
Material: PC, PP, PP

E slide cover
colours: transparent, frosted, opal
material: PC, PP, PP



Achtung! Die Abmessungen des Platzes für die Montage von LED Lichtquelle
Note! Dimensions of the space to install LED source

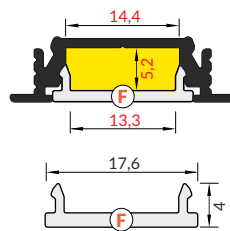
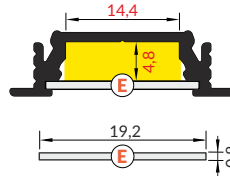

Abdeckung F einclipsbar
Farben: transparent, opal
Material: PMMA

F click cover
colours: transparent, opal
material: PMMA

Abdeckung E7 einclipsbar
Farben: opal
Material: PMMA

E7 click cover
colour: opal
material: PMMA

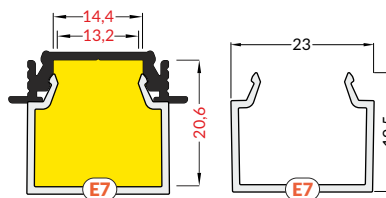

NEU

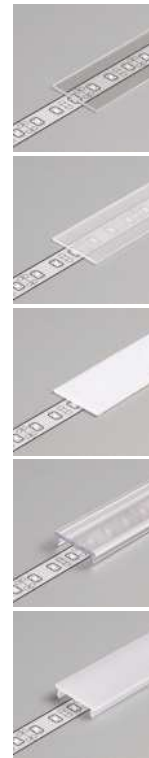

Länge 2.000 mm,
length 2000 mm

E transparent
Artikelnummer = 10 Stück
index = 10 pcs
95A2040016

E satiniert / E frosted
Artikelnummer = 10 Stück
index = 10 pcs
95A2040039

E opal
Artikelnummer = 10 Stück
index = 10 pcs
95A2040038

F transparent
Artikelnummer = 1 Stück
index = 1 pc
95A2060016

F opal
Artikelnummer = 1 Stück
index = 1 pc
95A2060038

Rolle, Länge 20 m,
reel, length 20 m

F opal
Artikelnummer = 1 Stück
index = 1 pc
95A2210038S

Länge 2.000 mm,
length 2000 mm

E7 opal
Artikelnummer = 1 Stück
index = 1 pc
95C1080038

Die Toleranz der Länge von Abdeckungen beträgt: +20 mm.
Mehr Informationen >> 1.08.
The standard cover length tolerance is +20 mm.
More details >> 1.08.

Artikelnummer = 1 Set = 2 Stück
INDEX = 1 set = 2 pcs

Endkappe **E7** opal
E7 opal ending
95C1840038

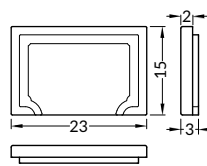

HALTER / MOUNTINGS

Halter Y flexibel
Farben: inox
Material: rostfreier Stahl
Y flexible mounting plate
colour: inox
material: stainless steel

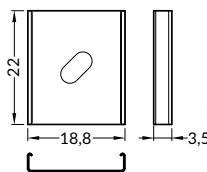
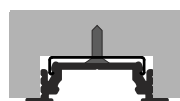

Artikelnummer = 10 Sets = 20 Stück
INDEX = 10 sets = 20 pcs

inox
95A2090019

Halter Y flexibel cone
Farben: inox
Material: rostfreier Stahl
cone **Y** flexible mounting plate
colour: inox
material: stainless steel

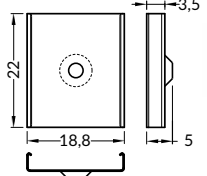
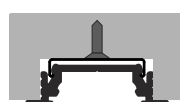

inox
95A2130019



HALTER / MOUNTINGS

Halter T
Farben: Rohaluminium
Material: Aluminium

T mounting plate
colour: raw aluminium
material: aluminium

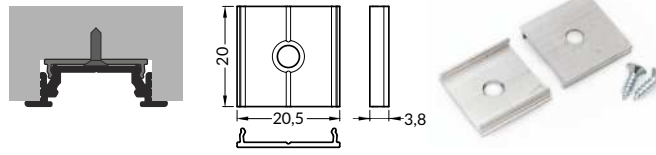

Artikelnummer = 10 Sets = 20 Stück
INDEX = 10 sets = 20 pcs

Rohaluminium
raw aluminium
95C6960000

ENDKAPPEN / ENDINGS

Endkappe GROOVE14 gen2 mit Öffnung
Farben: weiß, silbern, schwarz, grau
Material: ABS

GROOVE14 ending gen2 with hole
colours: white, silver, black, grey
material: ABS

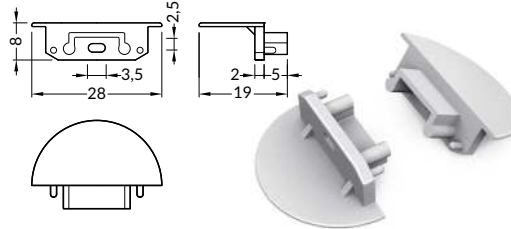

Artikelnummer = 10 Sets = 20 Stück
INDEX = 10 sets = 20 pcs

weiß / white
95A3970001
silbern / silver
95A3970040
schwarz / black
95A3970002
grau / grey
95A3970022

Endkappe GROOVE14 gen2 SQ mit Öffnung
Farben: weiß, silbern, schwarz, grau
Material: ABS

GROOVE14 ending gen2 SQ with hole
colours: white, silver, black, grey
material: ABS

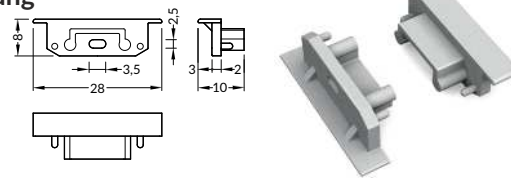

weiß / white
95A3980001
silbern / silver
95A3980040
schwarz / black
95A3980002
grau / grey
95A3980022

VERBINDUNGSTÜCKE / CONNECTOR

Verbindungsstück T 180 Grad
Farben: Rohaluminium
Material: Aluminium

T connector 180 deg
colour: raw aluminium
material: aluminium

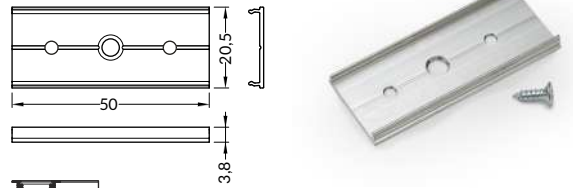

Artikelnummer = 1 Set
INDEX = 1 set

Rohaluminium
raw aluminium
95C6990000

Verbinder 90 Grad für GROOVE14
Farben: weiß, eloxiert, schwarz
Material: Aluminium

GROOVE14 connector 90 deg
colours: white, anodized, black
material: aluminium

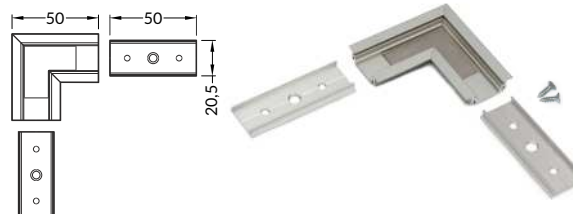

weiß lackiert
white painted
95A3990001
eloxiert
anodized
95A3990020
schwarz eloxiert
black anodized
95A3990021



SMART-IN16 BC3/U4

ÖKONOMISCHES EINBAUPROFIL FÜR LED STREIFEN MIT 16mm

ECONOMICAL RECESSED PROFILE FOR 16 mm LED STRIP

- SLICK Befestigungssockel - einfache Montage der Abdeckung
- verschiedene Montageweisen
- eine homogene Lichtlinie (beim Gebrauch eines LED Streifens mit 120 P/m und einer opalen Abdeckung)
- maximale Breite des LED Streifens: 16 mm
- SLICK socket - easy assembly technology
- various ways of mounting
- continuous line of light (when using LED strip 120 P/m and opal cover)
- maximum width of LED strip: 16 mm



ÄHNLICHES IM ANGEBOT / SIMILAR IN THE OFFER



SMART16
BC3/U4



SMART-IN10
AC2/Z



BEGTIN12
J/S



GROOVE14
EF/TY



LINEA-IN20
EF/U7

B Abdeckung **B** einschiebbar
B slide cover

C3 Abdeckung **C3** einclipsbar
C3 click cover

U4¹ Halter **U4**
U4 mounting plate

U4² Halter **U4** cone
cone U4 mounting plate

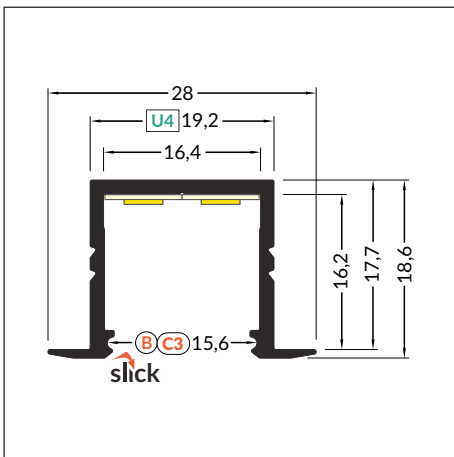
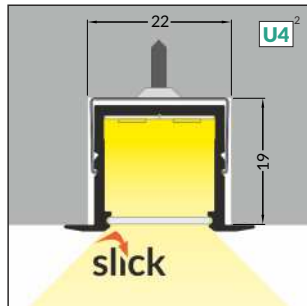
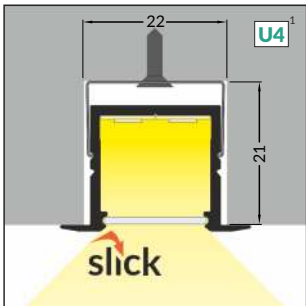
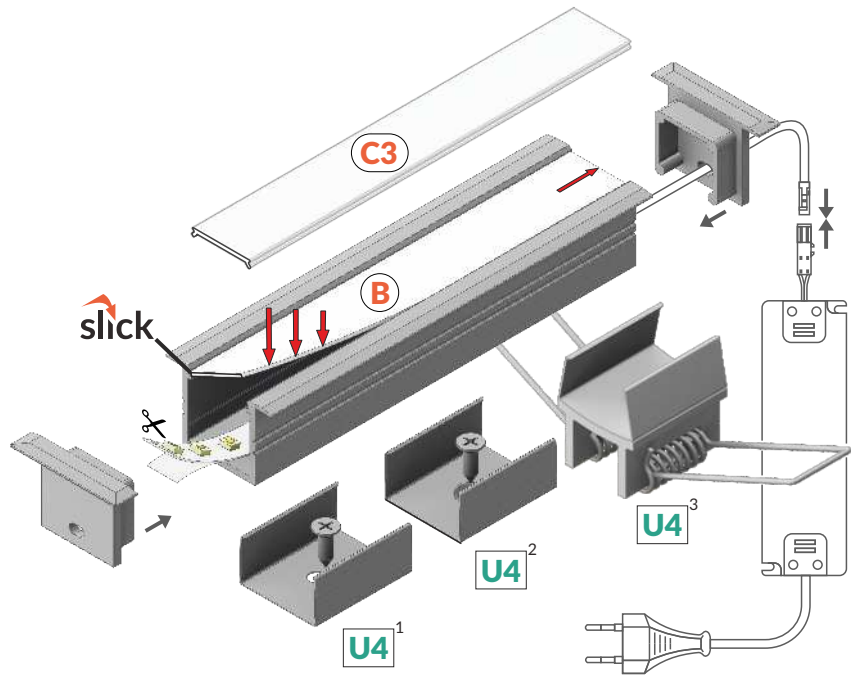

max 16 mm



Einbauprofile
recessed

Artikelnummer = 1 Stück, Länge 2.000 mm
INDEX = 1 pc, length 2000 mm

weiß lackiert
white painted
95F6000201

eloxiert
anodized
95F6000220

Rohaluminium
raw aluminium
95F6000200

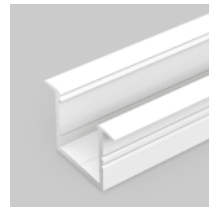

Die zugänglichen Längen: 1000 mm, 2000 mm, 3000 mm, 4000 mm.
Die standardmäßige Toleranz der Länge von Profilen beträgt: +20 mm.
Mehr Informationen >> 1.08.

Available lengths: 1000 mm, 2000 mm, 3000 mm, 4000 mm.
The standard profile length tolerance is +20 mm.
More details >> 1.08.



ABDECKUNG / COVERS

Abdeckung B einschiebbar
Farben: transparent, satiniert, opal
Material: PC, PP, PP

B slide cover
colours: transparent, frosted, opal
material: PC, PP, PP

Abdeckung C3 einclipsbar
Farben: transparent, opal
Material: PMMA

C3 click cover
colours: transparent, opal
material: PMMA

NEU

Achtung! Die Abmessungen des Platzes für die Montage von LED Lichtquelle
Note! Dimensions of the space to install LED source

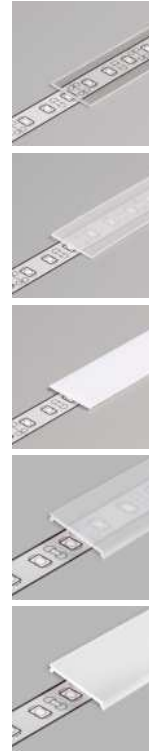
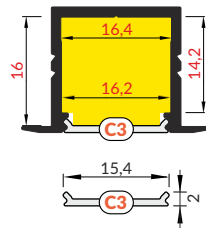
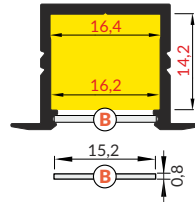

Länge 2.000 mm,
length 2000 mm

B transparent
Artikelnummer = 10 Stück
index = 10 pcs
9576250016

B satiniert / B frosted
Artikelnummer = 10 Stück
index = 10 pcs
9576250039

B opal
Artikelnummer = 10 Stück
index = 10 pcs
9576250038

C3 transparent
Artikelnummer = 1 Stück
index = 1 pc
95F1000216

C3 opal
Artikelnummer = 1 Stück
index = 1 pc
95F1000238

Die Toleranz der Länge von Abdeckungen beträgt: +20 mm.
Mehr Informationen >> 1.08.

The standard cover length tolerance is +20 mm.
More details >> 1.08.

ENDKAPPEN / ENDINGS

Endkappe SMART-IN16 mit Öffnung
Farben: weiß, silbern, grau
Material: ABS

SMART-IN16 ending with hole
colours: white, silver, grey
material: ABS

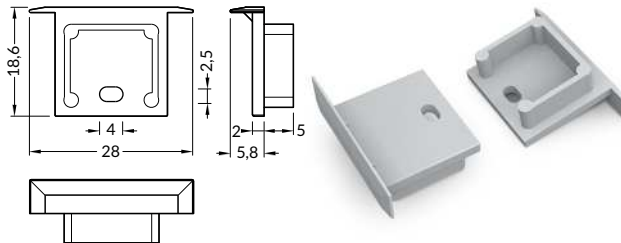

Artikelnummer = 10 Sets = 20 Stück
INDEX = 10 sets = 20 pcs

weiß / white
95F6009901

silbern / silver
95F6009940

grau / grey
95F6009922

HALTER / MOUNTINGS

Halter U4
Farben: weiß, inox
Material: rostfreier Stahl

U4 mounting plate
colour: white, inox
material: stainless steel

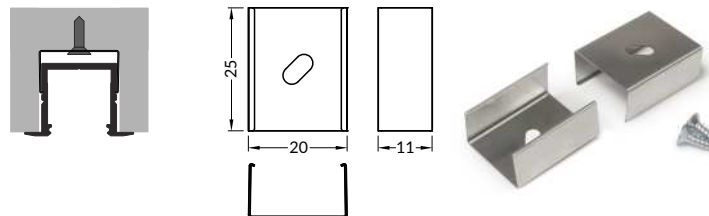

Artikelnummer = 10 Sets = 20 Stück
INDEX = 10 sets = 20 pcs

weiß / white
95F1970001

inox
95F1970019

Halter U4 cone
Farben: weiß, inox
Material: rostfreier Stahl

cone **U4** mounting plate
colour: white, inox
material: stainless steel

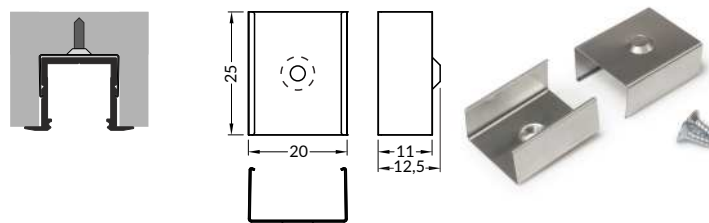

weiß / white
95F1980001

inox
95F1980019

ZUBEHÖR / ACCESSORIES

HALTER / MOUNTINGS

Halter **U4** Feder
Farben: inox
Material: rostfreier Stahl

spring **U4** mounting plate
colour: inox
material: stainless steel

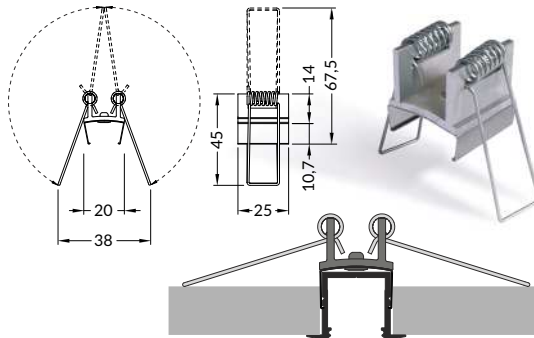

Artikelnummer = 1 Set = 2 Stück
INDEX = 1 set = 2 pcs

inox
95F6009819S



LINEA-IN20 EF/U7

BILDEN VON LICHTMODELLEN DANK DEN ECKVERBINDERN

CREATING LIGHTING PATTERNS THANKS TO ANGULAR CONNECTORS

- eine homogene Lichtlinie (bei LED Streifen mit 120 leds/m und einer opalen Abdeckung)
 - Lichtecken
 - mehr als 20 Zubehörteile
 - drei Möglichkeiten der Montage von LED Modulen:
mit einem Thermband, LED Modul auf einem Band, zusätzlich LED Klemme
 - maximale Breite des LED Streifens 20 mm
-
- continuous line of light (when using LED strip 120 P/m and opal cover)
 - angled connections illuminated
 - over 20 accessories available
 - 3 mounting options of LED modules: thermic tape, LED module on a strip, additionally LED clamp
 - maximum LED source width: 20 mm

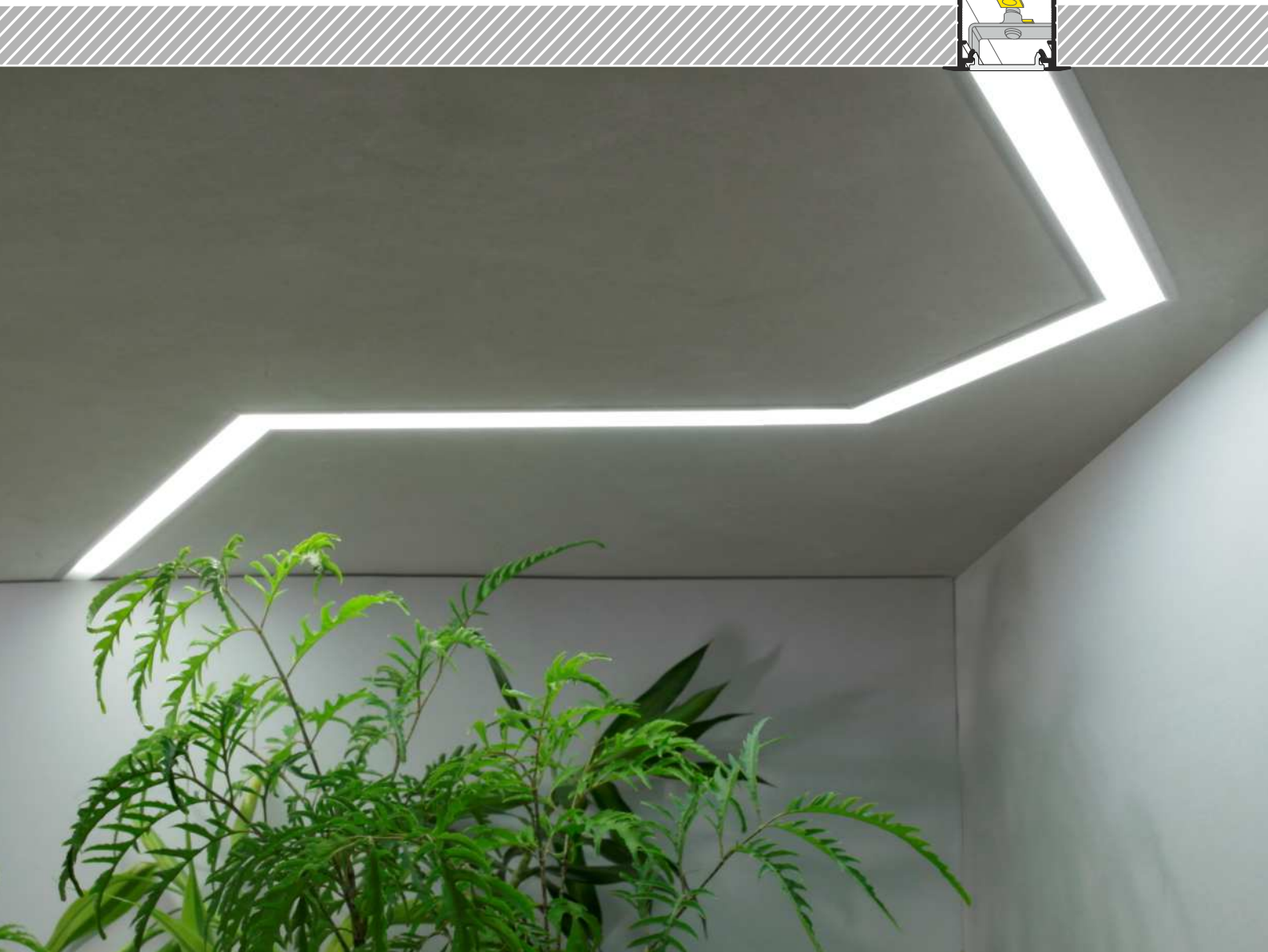
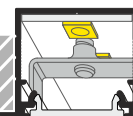

ÄHNLICHES IM ANGEBOT / SIMILAR IN THE OFFER





- E** Abdeckung **E** einziehbar
E slide cover
- F** Abdeckung **F** einclipsbar
F click cover
- E7** Abdeckung **E7** einclipsbar
E7 click cover
- U7**¹ Halter **U7**
U7 mounting plate
- U7**² Halter **U7** cone
cone U7 mounting plate
- U7**³ Halter **U7** rack
rack U7 mounting plate
- U7**⁴ Halter **U7** Feder
spring U7 mounting plate

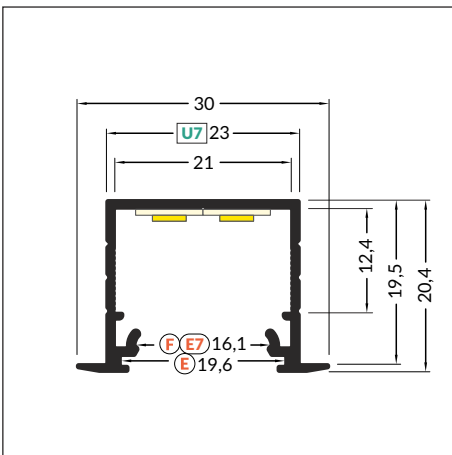
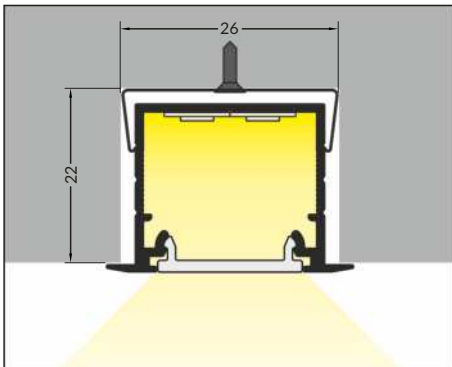
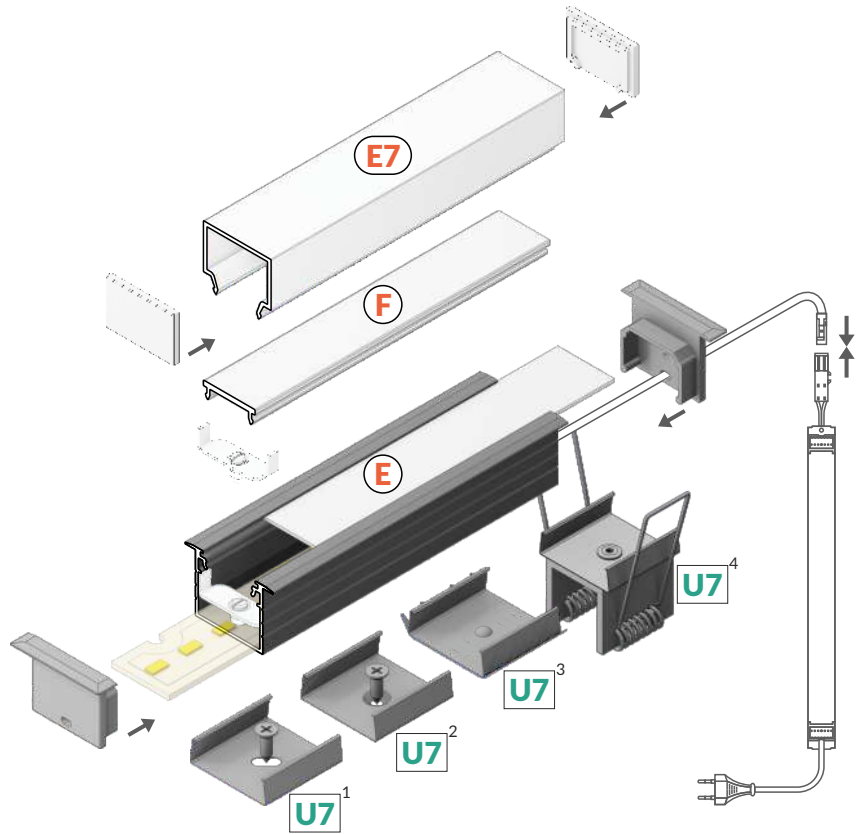

Artikelnummer = 1 Stück, Länge 2.000 mm
INDEX = 1 pc, length 2000 mm

weiß lackiert
white painted

95E4020001



eloxiert
anodized

95E4020020



schwarz eloxiert
black anodized

95E4020021



Rohaluminium
raw aluminium

95E4020000



max 20 mm



Einbauprofile
recessed

Die zugänglichen Längen: 1000 mm, 2000 mm, 3000 mm, 4000 mm.
Die standardmäßige Toleranz der Länge von Profilen beträgt: +20 mm.
Mehr Informationen >> 1.08.

Available lengths: 1000 mm, 2000 mm, 3000 mm, 4000 mm.
The standard profile length tolerance is +20 mm.
More details >> 1.08.



ABDECKUNG / COVERS

Abdeckung E einziehbar
Farben: transparent, satiniert, opal
Material: PC, PP, PP

E slide cover
colours: transparent, frosted, opal
material: PC, PP, PP



Achtung! Die Abmessungen des Platzes für die Montage von LED Lichtquelle
Note! Dimensions of the space to install LED source

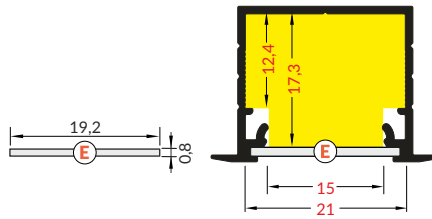

Länge 2.000 mm,
length 2000 mm

E transparent
Artikelnummer = 10 Stück
index = 10 pcs
95A2040016



E satiniert / **E** frosted
Artikelnummer = 10 Stück
index = 10 pcs
95A2040039

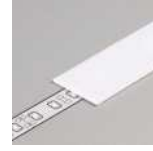

E opal
Artikelnummer = 10 Stück
index = 10 pcs
95A2040038

Abdeckung F einclipsbar
Farben: transparent, opal
Material: PMMA

F click cover
colours: transparent, opal
material: PMMA

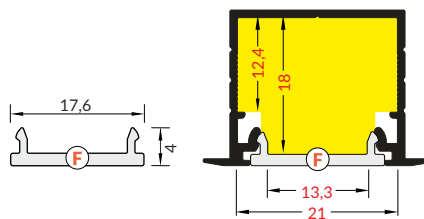

F transparent
Artikelnummer = 1 Stück
index = 1 pc
95A2060016



F opal
Artikelnummer = 1 Stück
index = 1 pc
95A2060038



Abdeckung E7 einclipsbar
Farben: opal
Material: PMMA

E7 click cover
colour: opal
material: PMMA

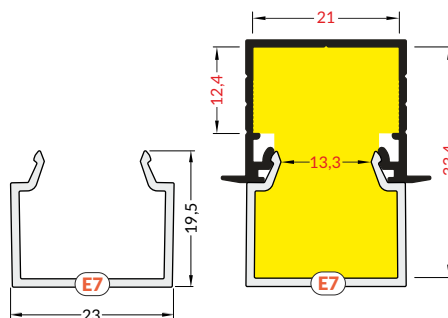

Rolle, Länge 20 m,
reel, length 20 m

F opal
Artikelnummer = 1 Stück
index = 1 pc
95A2210038S



Länge 2.000 mm,
length 2000 mm

E7 opal
Artikelnummer = 1 Stück
index = 1 pc
95C1080038

Die Toleranz der Länge von Abdeckungen beträgt: +20 mm.
Mehr Informationen >> 1.08.

The standard cover length tolerance is +20 mm.
More details >> 1.08.

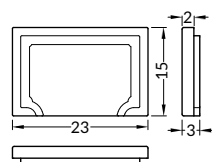

Artikelnummer = 1 Set = 2 Stück
INDEX = 1 set = 2 pcs

Endkappe **E7** opal
E7 opal ending
95C1840038

ENDKAPPEN / ENDINGS

Endkappe LINEA-IN20 mit Öffnung
Farben: weiß, silbern, schwarz, grau
Material: ABS

LINEA-IN20 ending with hole
colours: white, silver, black, grey
material: ABS

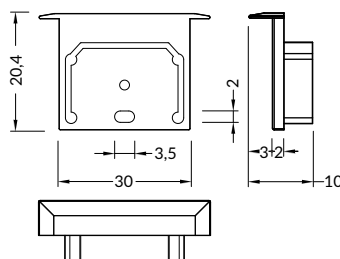

Artikelnummer = 10 Sets = 20 Stück
INDEX = 10 sets = 20 pcs

weiß / white
95E4990001

silbern / silver
95E4990040

schwarz / black
95E4990002

grau / grey
95E4990022



ENDKAPPEN / ENDINGS

Endkappe LINEA-IN20-E7
mit Öffnung **NEU**
Farben: weiß, silbern, schwarz, grau
Material: ABS
LINEA-IN20-E7 ending with hole
colours: white, silver, black, grey
material: ABS

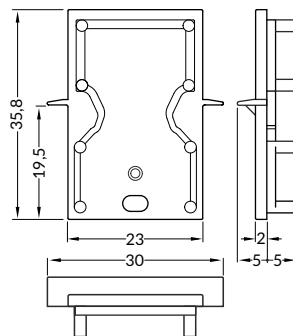

Artikelnummer = 10 Sets = 20 Stück
INDEX = 10 sets = 20 pcs

weiß / white
95E4999901
silbern / silver
95E4999940
schwarz / black
95E4999902
grau / grey
95E4999922

HALTER / MOUNTINGS

Halter **U7**
Farben: inox
Material: rostfreier Stahl
U7 mounting plate
colour: inox
material: stainless steel

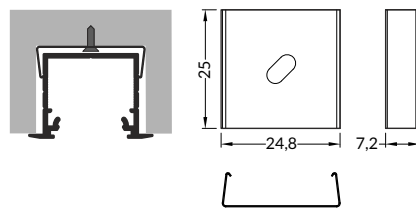

Artikelnummer = 10 Sets = 20 Stück
INDEX = 10 sets = 20 pcs

inox
95E4960019

Halter **U7 cone**
Farben: inox
Material: rostfreier Stahl
cone U7 mounting plate
colour: inox
material: stainless steel

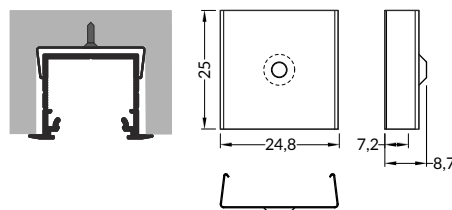

inox
95E4970019

Halter **U7 rack**
Farben: inox
Material: rostfreier Stahl
rack U7 mounting plate
colour: inox
material: stainless steel

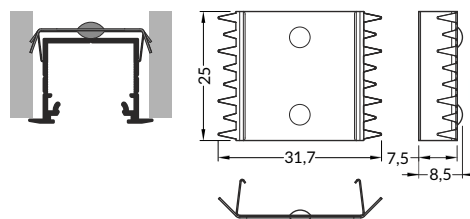

inox
95E4980019

Halter **U7 Feder**
Farben: inox
Material: rostfreier Stahl
spring U7 mounting plate
colour: inox
material: stainless steel

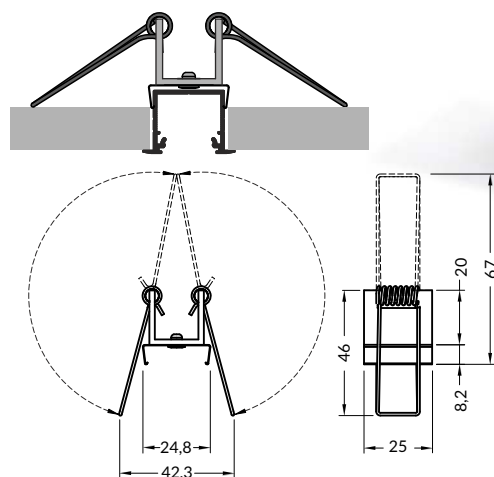

Artikelnummer = 1 Set = 2 Stück
INDEX = 1 set = 2 pcs

inox
95E4880019s

LINEA-IN20 EF/U7

VERBINDUNGSMÖGLICHKEITEN CONNECTION POSSIBILITY



60°



90°



120°



135°



180°

ECKVERBINDER

Dank den Eckverbindern mit fünf unterschiedlichen Winkeln (60° / 90° / 120° / 135° / 180°) ist die Bildung von vielen unterschiedlichen Lichtvarianten möglich ohne das Profil auf Gehrung zuschneiden zu müssen.

Gebogene Verbindungsstücke ermöglichen das Verbinden von zwei Profilen in zwei Ebenen, unter zwei Winkeln; dem inneren Winkel von 90° und dem äußeren Winkel von 270°.

ANGULAR CONNECTORS

Thanks to five different angle connectors (60° / 90° / 120° / 135° / 180°) it is possible to create many various lighting systems – with no need to cut the profile at an angle.

Bent connectors allows to connect profiles in two planes, at two angles: 90° on the inside and 270° on the outside.

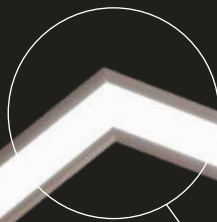

Ein Element aus durchsichtigem Kunststoff sichert die Stabilisierung der Verbindung und gleichzeitig lässt sie das Licht durch. Diese Lösung ermöglicht das Leuchten der Gehäuse auf der ganzen Fläche - auch in den Ecken.

The component made of clear fabric provides secure connection, letting light through at the same time. Thanks to that, the luminaire can illuminate on the entire surface of the cover – even in the corners.



VERBINDUNGSTÜCKE / CONNECTORS

Verbinder 60 Grad für LINEA-IN20
Farben: weiß, eloxiert, schwarz
Material: Aluminium, Polycarbonat

LINEA-IN20 connector 60 deg
colours: white, anodized, black
material: aluminium, polycarbonate

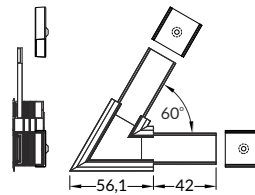

Artikelnummer = 1 Set
INDEX = 1 set

weiß lackiert / white painted
95E4890001s

eloxiert / anodized
95E4890002s

schwarz eloxiert / black anodized
95E48900021s

Verbinder 90 Grad für LINEA-IN20
Farben: weiß, eloxiert, schwarz
Material: Aluminium, Polycarbonat

LINEA-IN20 connector 90 deg
colours: white, anodized, black
material: aluminium, polycarbonate

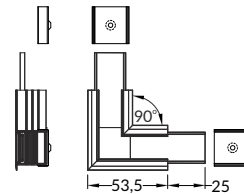

weiß lackiert / white painted
95E4900001s

eloxiert / anodized
95E4900002s

schwarz eloxiert / black anodized
95E49000021s

Verbinder 90 Grad für LINEA-IN20 gebogen
Farben: weiß, eloxiert, schwarz
Material: Aluminium, Polycarbonat

LINEA-IN20 connector 90 deg bent
colours: white, anodized, black
material: aluminium, polycarbonate

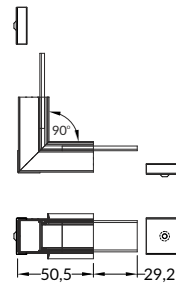

weiß lackiert / white painted
95E4910001s

eloxiert / anodized
95E4910002s

schwarz eloxiert / black anodized
95E49100021s

Verbinder 120 Grad für LINEA-IN20
Farben: weiß, eloxiert, schwarz
Material: Aluminium, Polycarbonat

LINEA-IN20 connector 120 deg
colours: white, anodized, black
material: aluminium, polycarbonate

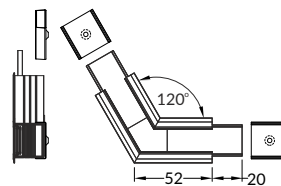

weiß lackiert / white painted
95E4920001s

eloxiert / anodized
95E4920002s

schwarz eloxiert / black anodized
95E49200021s

Verbinder 135 Grad für LINEA-IN20
Farben: weiß, eloxiert, schwarz
Material: Aluminium, Polycarbonat

LINEA-IN20 connector 135 deg
colours: white, anodized, black
material: aluminium, polycarbonate

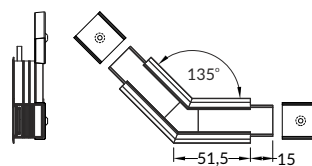

weiß lackiert / white painted
95E4930001s

eloxiert / anodized
95E4930002s

schwarz eloxiert / black anodized
95E49300021s

Verbinder 180 Grad für LINEA-IN20
Material: Polycarbonat

LINEA-IN20 connector 180 deg
material: polycarbonate

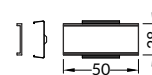

95E4940000s

Verbinder 270 Grad für LINEA-IN20 gebogen
Farben: weiß, eloxiert, schwarz
Material: Aluminium, Polycarbonat

LINEA-IN20 connector 270 deg bent
colours: white, anodized, black
material: aluminium, polycarbonate

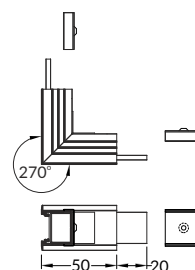

weiß lackiert / white painted
95E4950001s

eloxiert / anodized
95E4950002s

schwarz eloxiert / black anodized
95E49500021s



KLEMME / CLAMP

Klemme für LEDs für LINEA20

Farben: weiß

Material: Stahl, Kunststoff

LINEA20 LED clamp

colour: white

material: painted steel, plastic

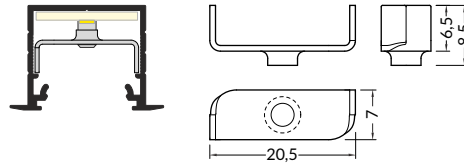

Klemme für LEDs für LINEA20-1

Farben: weiß

Material: Stahl, Kunststoff

LINEA20-1 LED clamp

colour: white

material: painted steel, plastic

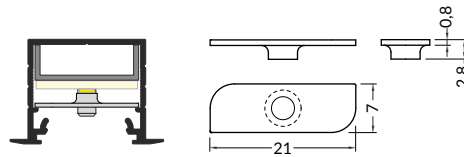

Artikelnummer = 10 Sets = 20 Stück
INDEX = 10 sets = 20 pcs

weiß / white
95C6940001

weiß / white
95C6930001

MONTAGETEIL FÜR LED / LED MOUNTING

Montageteil LED für LINEA20

Material: Aluminium

Montageteil LED für LINEA20

Material: Aluminium

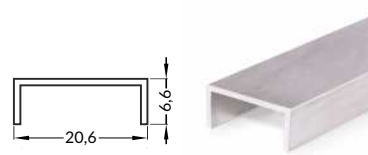

Artikelnummer = 1 Stück, Länge 2.000 mm
INDEX = 1 pc, length 2000 mm

Rohaluminium
raw aluminium
95C6060000

Die zugänglichen Längen: 1000 mm, 2000 mm, 3000 mm, 4000 mm. Die standardmäßige Toleranz der Länge von Profilen beträgt: +20 mm. Mehr Informationen >> 1.08.

Available lengths: 1000 mm, 2000 mm, 3000 mm, 4000 mm. The standard profile length tolerance is +20 mm. More details >> 1.08.

LEUCHTEFFEKT / LIGHTING EFFECT

LED Montageteil für LINEA20 + LED Klemme LINEA20-1 / LINEA20 LED mounting + LINEA20-1 LED clamp



Leuchteffekt ohne die Einschiebepatte für LED bei dem Profil LINEA20 zu verwenden / Lighting effect without LINEA20 LED mounting



EINE HOMOGENE LICHTLINIE
bei LED Streifen mit 120 leds/m und einer opalen Abdeckung

CONTINUOUS LIGHT OF LINE
when using LED strip 120 P/m and opal cover



LINEA-IN20 TRIMLESS EF

GERINGERE SICHTBARKEIT DES PROFILRANDES

REDUCED VISIBILITY OF PROFILE EDGE

- für Spachteltechnik
- SLICK Befestigungssockel - einfache Montage der Abdeckung
- drei Möglichkeiten der Montage von LED Modulen
- eine homogene Lichtlinie (beim Gebrauch eines LED Streifens mit 120 P/m und einer opalen Abdeckung)
- maximale Breite des LED Streifens: 20 mm

- for spackle flange mounting
- Slick socket - easy assembly technology
- 3 mounting options of LED modules
- continuous line of light (when using LED strip 120 P/m and opal cover)
- maximum LED source width: 20 mm



ÄHNLICHES IM ANGEBOT / SIMILAR IN THE OFFER



LINEA20
EF/TY

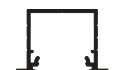

LINEA-IN20
EF/U7

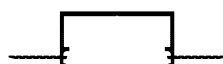

VARIO30-04



VARIO30-05

- E** Abdeckung **E** einziehbar
E slide cover
- F** Abdeckung **F** einclipsbar
F click cover
- E7** Abdeckung **E7** einclipsbar
E7 click cover

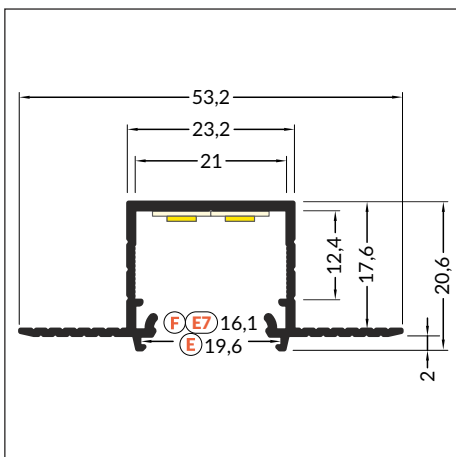
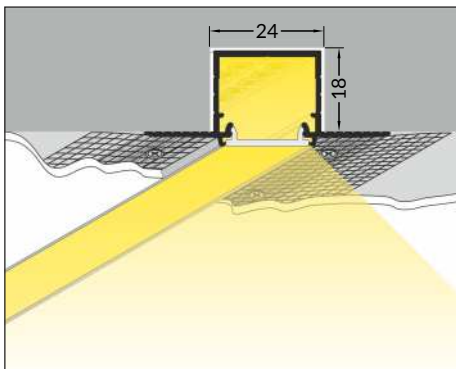
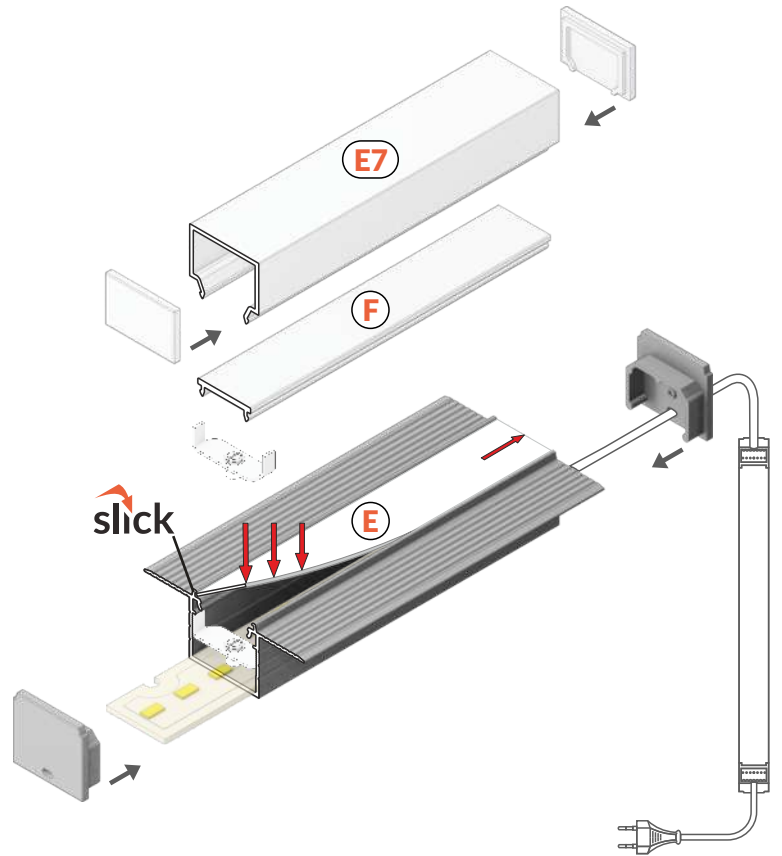

max 20 mm



Einbauprofile
recessed



Artikelnummer = 1 Stück, Länge 2.000 mm
INDEX = 1 pc, length 2000 mm

weiß lackiert
white painted
95G1000201



eloxiert
anodized
95G1000220



Rohaluminium
raw aluminium
95G1000200

Die zugänglichen Längen: 1000 mm, 2000 mm, 3000 mm, 4000 mm.
Die standardmäßige Toleranz der Länge von Profilen beträgt: +20 mm.
Mehr Informationen >> 1.08.

Available lengths: 1000 mm, 2000 mm, 3000 mm, 4000 mm.
The standard profile length tolerance is +20 mm.
More details >> 1.08.



ABDECKUNG / COVERS

Abdeckung E einziehbar
Farben: transparent, satiniert, opal
Material: PC, PP, PP

E slide cover
colours: transparent, frosted, opal
material: PC, PP, PP

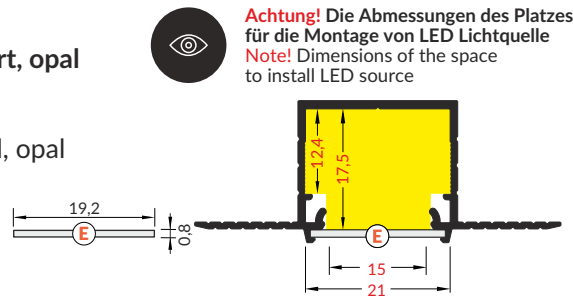

Abdeckung F einclipsbar
Farben: transparent, opal
Material: PMMA

F click cover
colours: transparent, opal
material: PMMA

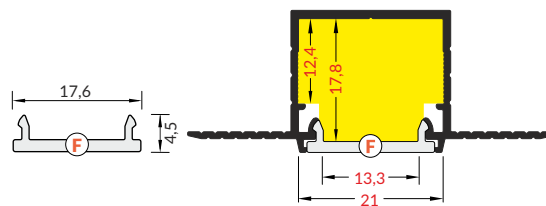

Abdeckung E7 einclipsbar
Farben: opal
Material: PMMA

E7 click cover
colour: opal
material: PMMA

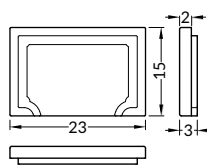
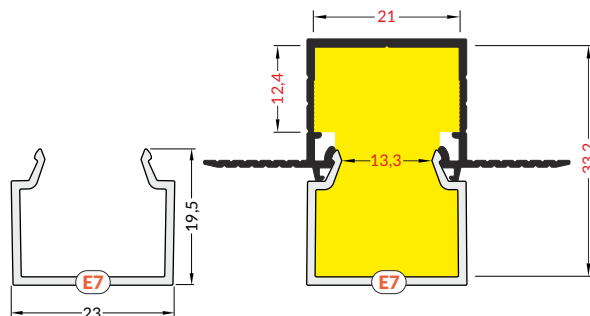

ENDKAPPE / ENDINGS

Endkappe LINEA-IN20 TRIMLESS mit Öffnung
Farben: weiß, silbern, grau
Material: ABS

LINEA-IN20 TRIMLESS ending with hole
colours: white, silver, grey
material: ABS

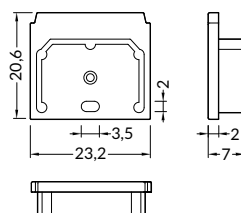

Länge 2.000 mm,
length 2000 mm

E transparent
Artikelnummer = 10 Stück
index = 10 pcs
95A2040016

E satiniert / E frosted
Artikelnummer = 10 Stück
index = 10 pcs
95A2040039

E opal
Artikelnummer = 10 Stück
index = 10 pcs
95A2040038

F transparent
Artikelnummer = 1 Stück
index = 1 pc
95A2060016

F opal
Artikelnummer = 1 Stück
index = 1 pc
95A2060038

Rolle, Länge 20 m,
reel, length 20 m

F opal
Artikelnummer = 1 Stück
index = 1 pc
95A2210038S

Länge 2.000 mm,
length 2000 mm

E7 opal
Artikelnummer = 1 Stück
index = 1 pc
95C1080038

Die Toleranz der Länge von Abdeckungen beträgt: +20 mm.
Mehr Informationen >> 1.08.
The standard cover length tolerance is +20 mm.
More details >> 1.08.

Artikelnummer = 1 Set = 2 Stück
INDEX = 1 set = 2 pcs

Endkappe **E7** opal
E7 opal ending
95C1840038

Artikelnummer = 10 Sets = 20 Stück
INDEX = 10 sets = 20 pcs

weiß / white
95G1000501

silbern / silver
95G1000540

grau / grey
95G1000522



KLEMME / CLAMP

Klemme für LEDs für LINEA20

Farben: weiß
Material: Stahl, Kunststoff

LINEA20 LED clamp
colour: white
material: painted steel, plastic

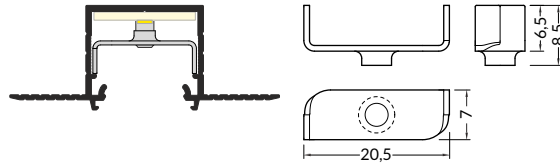

Artikelnummer = 10 Sets = 20 Stück
INDEX = 10 sets = 20 pcs

weiß / white
95C6940001

Klemme für LEDs für LINEA20-1

Farben: weiß
Material: Stahl, Kunststoff

LINEA20-1 LED clamp
colour: white
material: painted steel, plastic

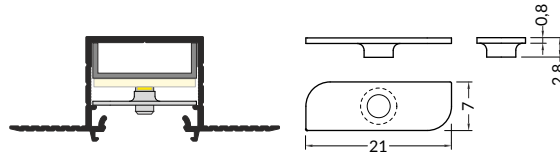

weiß / white
95C6930001

MONTAGETEIL FÜR LED / LED MOUNTING

Montageteil LED für LINEA20

Material: Aluminium

LINEA20 LED mounting
material: aluminium

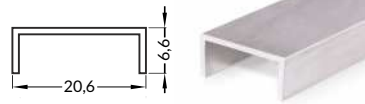

Artikelnummer = 1 Stück, Länge 2.000 mm
INDEX = 1 pc, length 2000 mm

Rohaluminium
raw aluminium
95C6060000

Die zugänglichen Längen: 1000 mm, 2000 mm, 3000 mm, 4000 mm. Die standardmäßige Toleranz der Länge von Profilen beträgt: +20 mm. Mehr Informationen >> 1.08.

Available lengths: 1000 mm, 2000 mm, 3000 mm, 4000 mm. The standard profile length tolerance is +20 mm. More details >> 1.08.



TRIO10 BC

ECKPROFIL 45°

ANGULAR PROFILE 45°

- für Vitrinenecken (Montage mit Schrauben)
- für Einbau (Befestigung mit Montageklebstoff)
- es eignet sich auch für die Beleuchtung von Treppen
- maximale Breite des LED Streifens 10 mm

- for display cases' corners (mounted with screws)
- recessed (mounted with adhesive glue)
- suitable also for lighting up steps
- maximum LED strip width: 10 mm

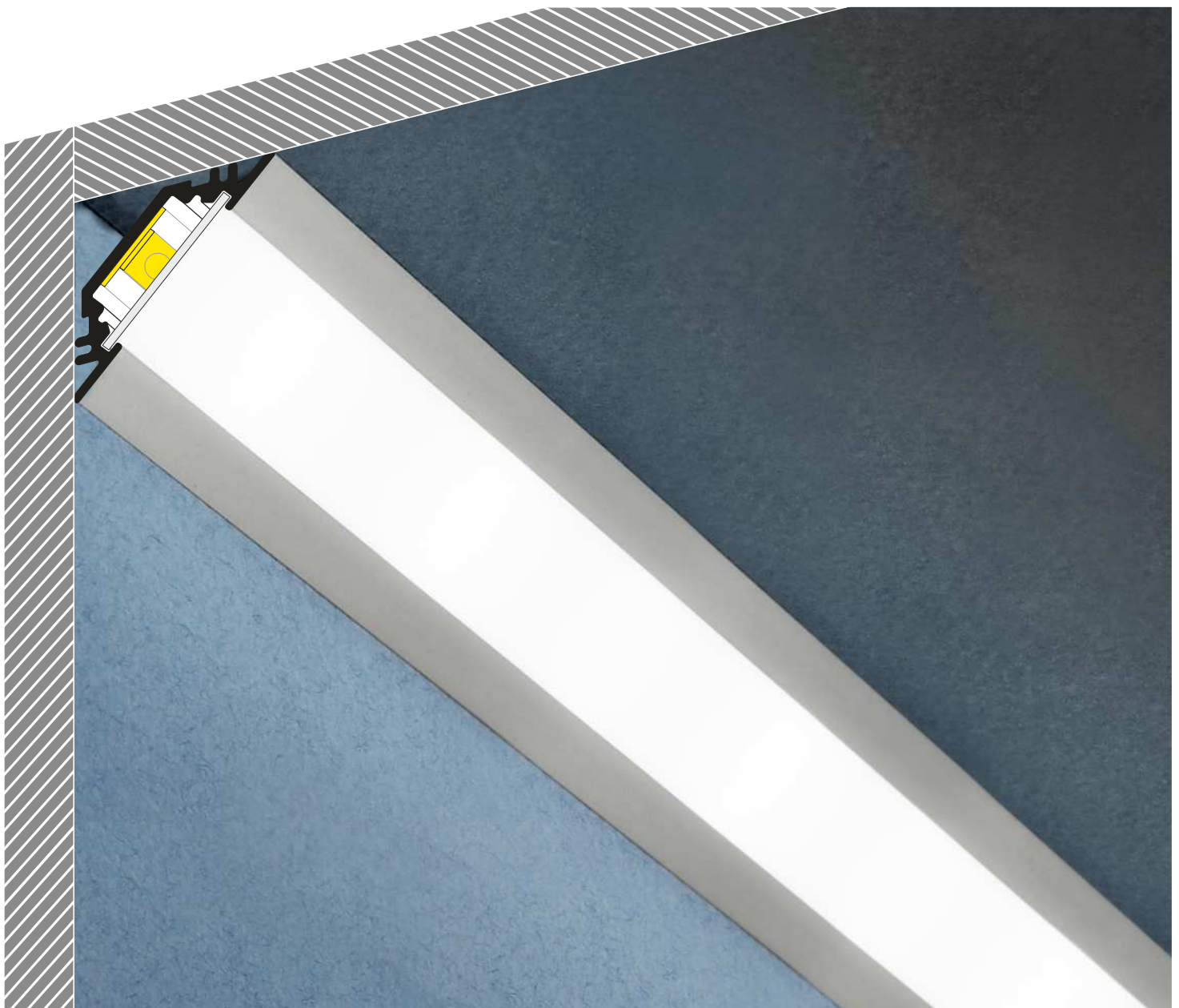

ÄHNLICHES IM ANGEBOT / SIMILAR IN THE OFFER



CORNER10
BC/UX



QUARTER10
BD/U6



CABI12
E



CORNER14
EF/TY



- B** Abdeckung **B** einschiebbar
B slide cover
- C** Abdeckung **C** einclipsbar
C click cover
- C** Abdeckung **C** einclipsbar Linse
C lens cover

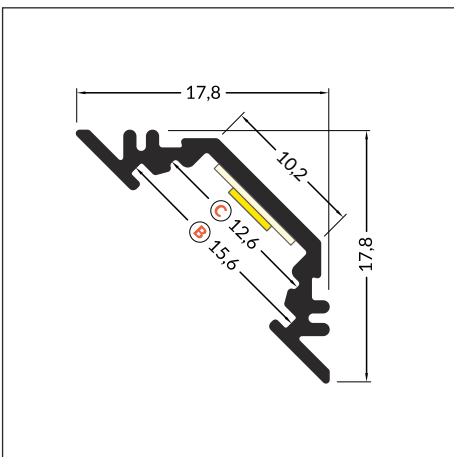
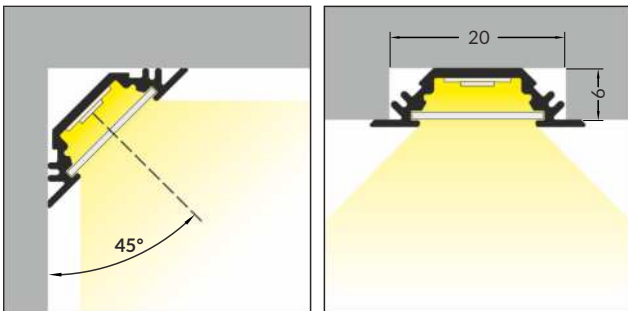
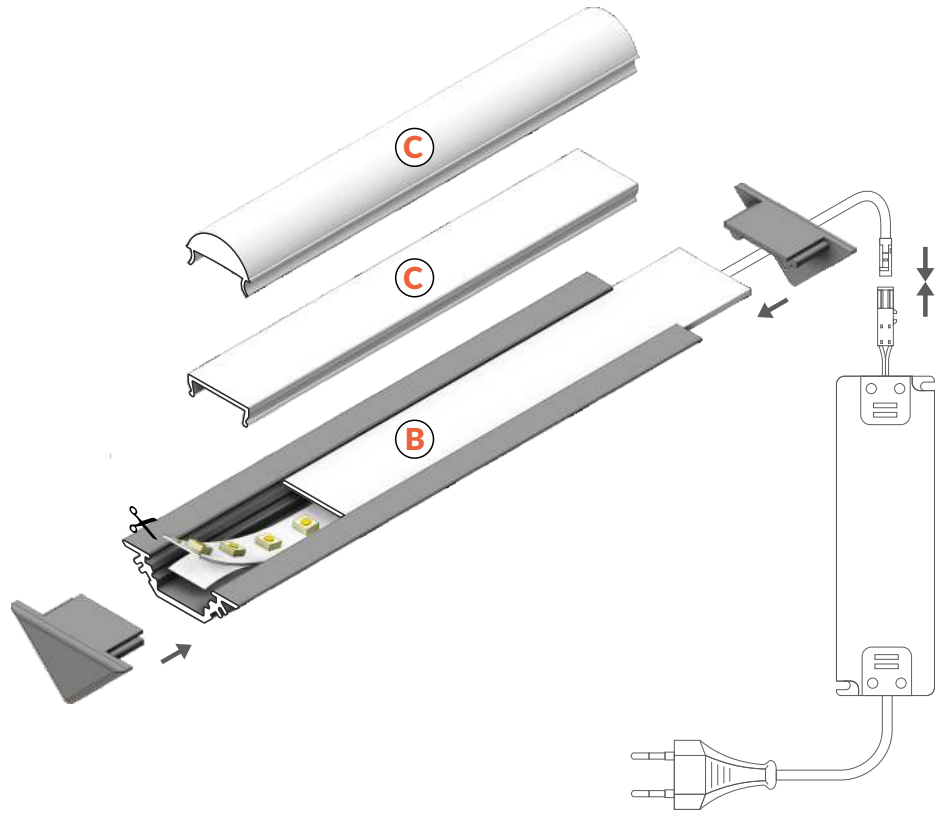

Artikelnummer = 1 Stück,
Länge 2.000 mm,
INDEX = 1 pc, length 2000 mm

weiß lackiert
white painted
9591030001



eloxiert
anodized
9591030020



schwarz eloxiert
black anodized
9591030021



Rohaluminium
raw aluminium
9591030000

Die zugänglichen Längen: 1000 mm, 2000 mm, 3000 mm, 4000 mm.
Die standardmäßige Toleranz der Länge von Profilen beträgt: +20 mm.
Mehr Informationen >> 1.08.

Available lengths: 1000 mm, 2000 mm, 3000 mm, 4000 mm.
The standard profile length tolerance is +20 mm.
More details >> 1.08.



ABDECKUNG / COVERS

Abdeckung B einschiebbar
Farben: transparent, satiniert, opal
Material: PC, PP, PP

B slide cover
colours: transparent, frosted, opal
material: PC, PP, PP



Achtung! Die Abmessungen des Platzes für die Montage von LED Lichtquelle
Note! Dimensions of the space to install LED source

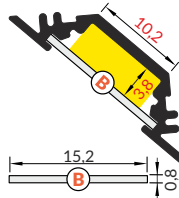

Länge 2.000 mm,
length 2000 mm

B transparent
Artikelnummer = 10 Stück
index = 10 pcs
9576250016

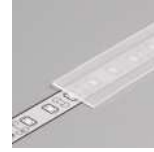

B satiniert / B frosted
Artikelnummer = 10 Stück
index = 10 pcs
9576250039

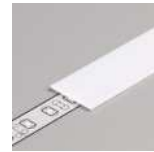

B opal
Artikelnummer = 10 Stück
index = 10 pcs
9576250038



C transparent
Artikelnummer = 1 Stück
index = 1 pc
9576330000



C opal
Artikelnummer = 1 Stück
index = 1 pc
9576330038

Abdeckung C einclipsbar
Farben: transparent, opal
Material: PMMA

C click cover
colours: transparent, opal
material: PMMA

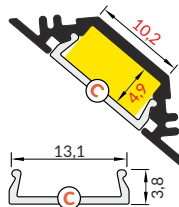

Rolle, Länge 20 m,
reel, length 20 m

C opal
Artikelnummer = 1 Stück
index = 1 pc
9576360038S



Länge 2.000 mm,
length 2000 mm

C Linse / C lens
Artikelnummer = 1 Stück
index = 1 pc
9576300000

Abdeckung C einclipsbar Linse
Farben: transparent
Material: PC

C lens click cover
colour: transparent
material: PC

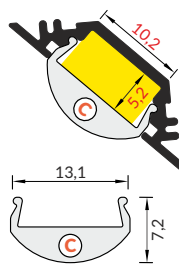

NEU

Die Toleranz der Länge von Abdeckungen beträgt: +20 mm.
Mehr Informationen >> 1.08.

The standard cover length tolerance is +20 mm.
More details >> 1.08.

ENDKAPPEN / ENDINGS

Endkappe TRIO10
Farben: weiß, silbern, schwarz, grau
Material: ABS
TRIO10 ending
colours: white, silver, black, grey
material: ABS

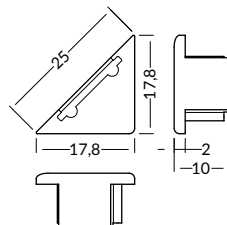

Artikelnummer = 10 Sets = 20 Stück
INDEX = 10 sets = 20 pcs

weiß / white
9591060001

silbern / silver
9591060040

schwarz / black
9591060002

grau / grey
9591060022



Die Endkappe mit Punkten für das Bohren von Öffnungen.
Ending with marked space to bore the holes.

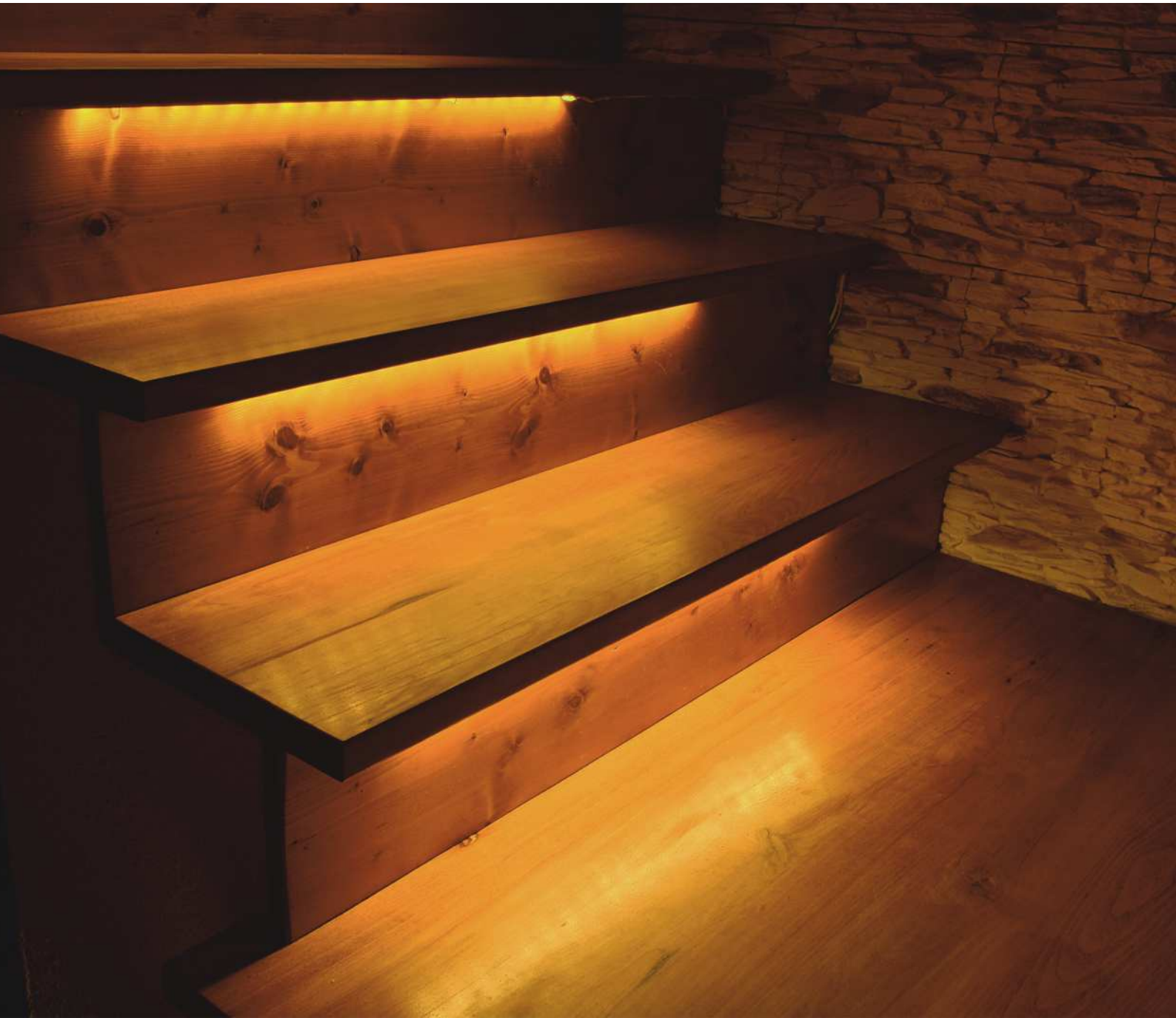

CORNER10 BC/UX

EIN KLEINES ALUMINIUMPROFIL FÜR ECKEN

SMALL, ALUMINIUM, ANGULAR PROFILE

- zwei Leuchtwinkel 30° und 60°
- eine versteckte Befestigung
- eine breite Auswahl von Zubehör, 6 Arten der Abdeckungen
- maximale Breite des LED Streifens 10 mm

- lighting directions: 30° or 60°
- hidden mounting
- wide range of accessories, 6 types of covers
- maximum LED strip width: 10 mm



ÄHNLICHES IM ANGEBOT / SIMILAR IN THE OFFER



TRIO10
BC



QUARTER10
BD/UX6



CABI12
E



CORNER14
EF/TY



CORNER27
G/UX



- B** Abdeckung **B** einschiebbar
B slide cover
- C** Abdeckung **C** einclipsbar
C click cover
- C** Abdeckung **C** einclipsbar Linse
C lens cover
- U**¹ Halter **U** flexibel
U flexible mounting plate
- U**² Halter **U** flexibel cone
cone U flexible mounting plate
- X**¹ Halter **X**
X mounting plate

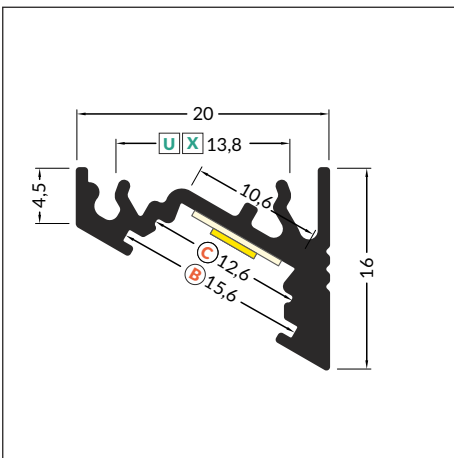
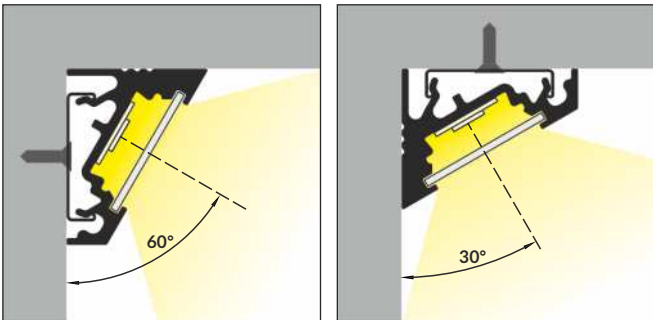
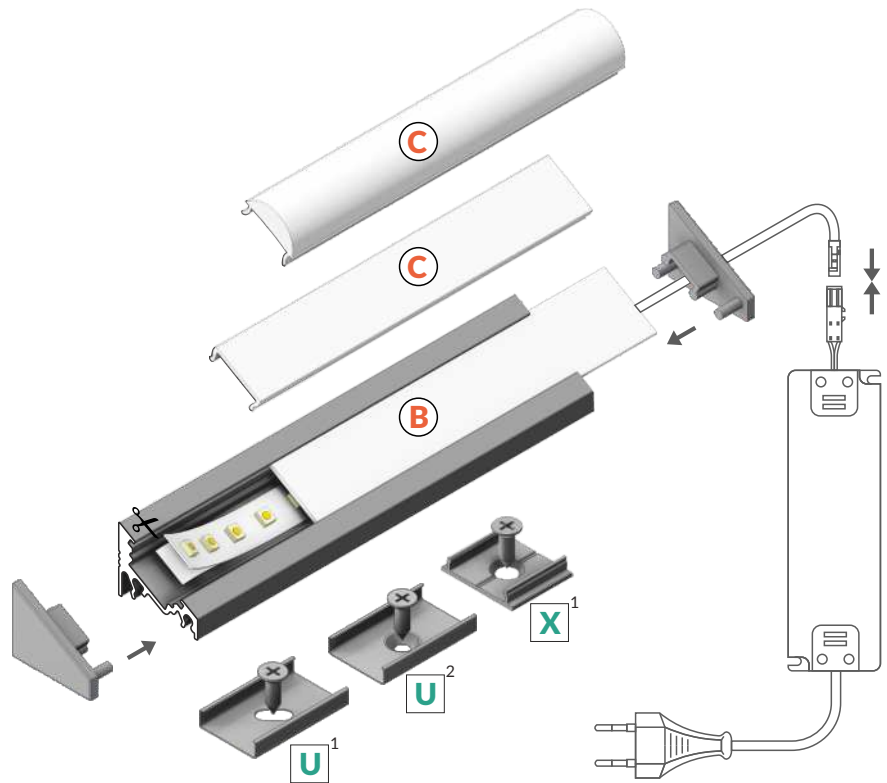

Artikelnummer = 1 Stück,
Länge 2.000 mm,
INDEX = 1 pc, length 2000 mm

weiß lackiert
white painted
9583050001

eloxiert
anodized
9583050020

schwarz eloxiert
black anodized
9583050021

Rohaluminium
raw aluminium
9583050000

Die zugänglichen Längen: 1000 mm, 2000 mm, 3000 mm, 4000 mm.
Die standardmäßige Toleranz der Länge von Profilen beträgt: +20 mm.
Mehr Informationen >> 1.08.

Available lengths: 1000 mm, 2000 mm, 3000 mm, 4000 mm.
The standard profile length tolerance is +20 mm.
More details >> 1.08.



ABDECKUNG / COVERS

Abdeckung B einziehbar
Farben: transparent, satiniert, opal
Material: PC, PP, PP

B slide cover
colours: transparent, frosted, opal
material: PC, PP, PP

Abdeckung C einclipsbar
Farben: transparent, opal
Material: PMMA

C click cover
colours: transparent, opal
material: PMMA

Abdeckung C einclipsbar Linse
Farben: transparent
Material: PC

C lens click cover
colour: transparent
material: PC



Achtung! Die Abmessungen des Platzes für die Montage von LED Lichtquelle
Note! Dimensions of the space to install LED source

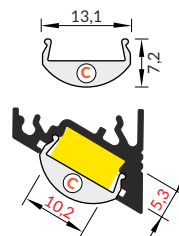
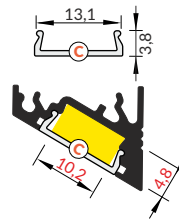
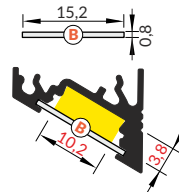

Länge 2.000 mm,
length 2000 mm

B transparent
Artikelnummer = 10 Stück
index = 10 pcs
9576250016

B satiniert / B frosted
Artikelnummer = 10 Stück
index = 10 pcs
9576250039

B opal
Artikelnummer = 10 Stück
index = 10 pcs
9576250038

C transparent
Artikelnummer = 1 Stück
index = 1 pc
9576330000

C opal
Artikelnummer = 1 Stück
index = 1 pc
9576330038

NEU



Rolle, Länge 20 m,
reel, length 20 m

C opal
Artikelnummer = 1 Stück
index = 1 pc
9576360038S



Länge 2.000 mm,
length 2000 mm

C Linse / C lens
Artikelnummer = 1 Stück
index = 1 pc
9576300000

Die Toleranz der Länge von Abdeckungen beträgt: +20 mm.
Mehr Informationen >> 1.08.
The standard cover length tolerance is +20 mm.
More details >> 1.08.

ENDKAPPEN / ENDINGS

Endkappe CORNER10 gen2
Farben: weiß, silbern, schwarz, grau
Material: ABS
CORNER10 ending gen2
colours: white, silver, black, grey
material: ABS

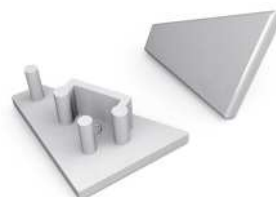
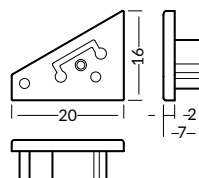

Endkappe CORNER10 gen2 mit Öffnung
Farben: weiß, silbern, schwarz, grau
Material: ABS
CORNER10 ending gen2 with hole
colours: white, silver, black, grey
material: ABS

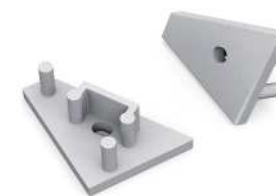
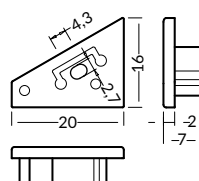

Artikelnummer = 10 Sets = 20 Stück
INDEX = 10 sets = 20 pcs

weiß / white

9583990001

silbern / silver

9583990040

schwarz / black

9583990002

grau / grey

9583990022

weiß / white

9583980001

silbern / silver

9583980040

schwarz / black

9583980002

grau / grey

9583980022



VERBINDUNGSTÜCKE / CONNECTORS

Verbindungsstück X 180 Grad
Farben: Rohaluminium
Material: Aluminium

X connector 180 deg
colour: raw aluminium
material: aluminium

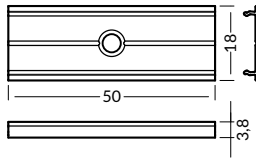

Artikelnummer = 1 Set
INDEKS = 1 set

Rohaluminium
raw aluminium
9576350000

Artikelnummer = 1 Set
INDEKS = 1 set

weiß lackiert
white painted
9583110001

eloxiert
anodized
9583110020

schwarz eloxiert
black anodized
9583110021

Verbinder 90 Grad für CORNER10
Farben: weiß, eloxiert, schwarz
Material: Aluminium

CORNER10 connector 90 deg
colours: white, anodized, black
material: aluminium

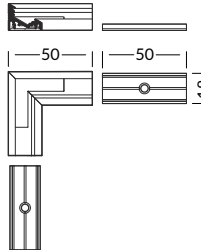

HALTER / MOUNTINGS

Halter U flexibel
Farben: inox
Material: rostfreier Stahl

U flexible mounting plate
colours: inox
material: stainless steel

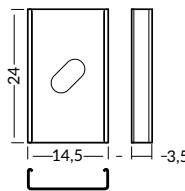
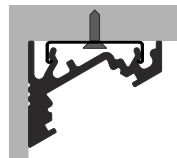

Artikelnummer = 10 Sets = 20 Stück
INDEX = 10 sets = 20 pcs

inox
9576380000

Halter U flexibel cone
Farben: inox
Material: rostfreier Stahl

cone U flexible mounting plate
colours: inox
material: stainless steel

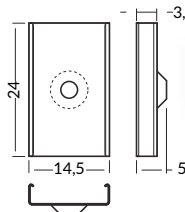
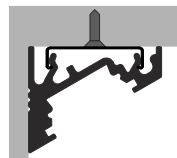

inox
9576620000

Halter X
Farben: Rohaluminium
Material: Aluminium

X mounting plate
colours: raw aluminium
material: aluminium

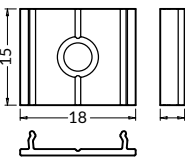
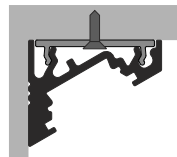

Rohaluminium
raw aluminium
9576260000



QUARTER10 BD/U6

ECKLICHT

LIGHT FROM AN ANGLE

- volle Beleuchtung eines Viertelkreises
- 45 Grad Abstrahlwinkel der Lichtquelle
- Sockel mit Slick Funktion
- maximale Breite des LED Streifens 10 mm

- full circle quadrant illumination
- LED strip aligned to 45° angle
- Slick socket
- maximum LED strip width: 10 mm

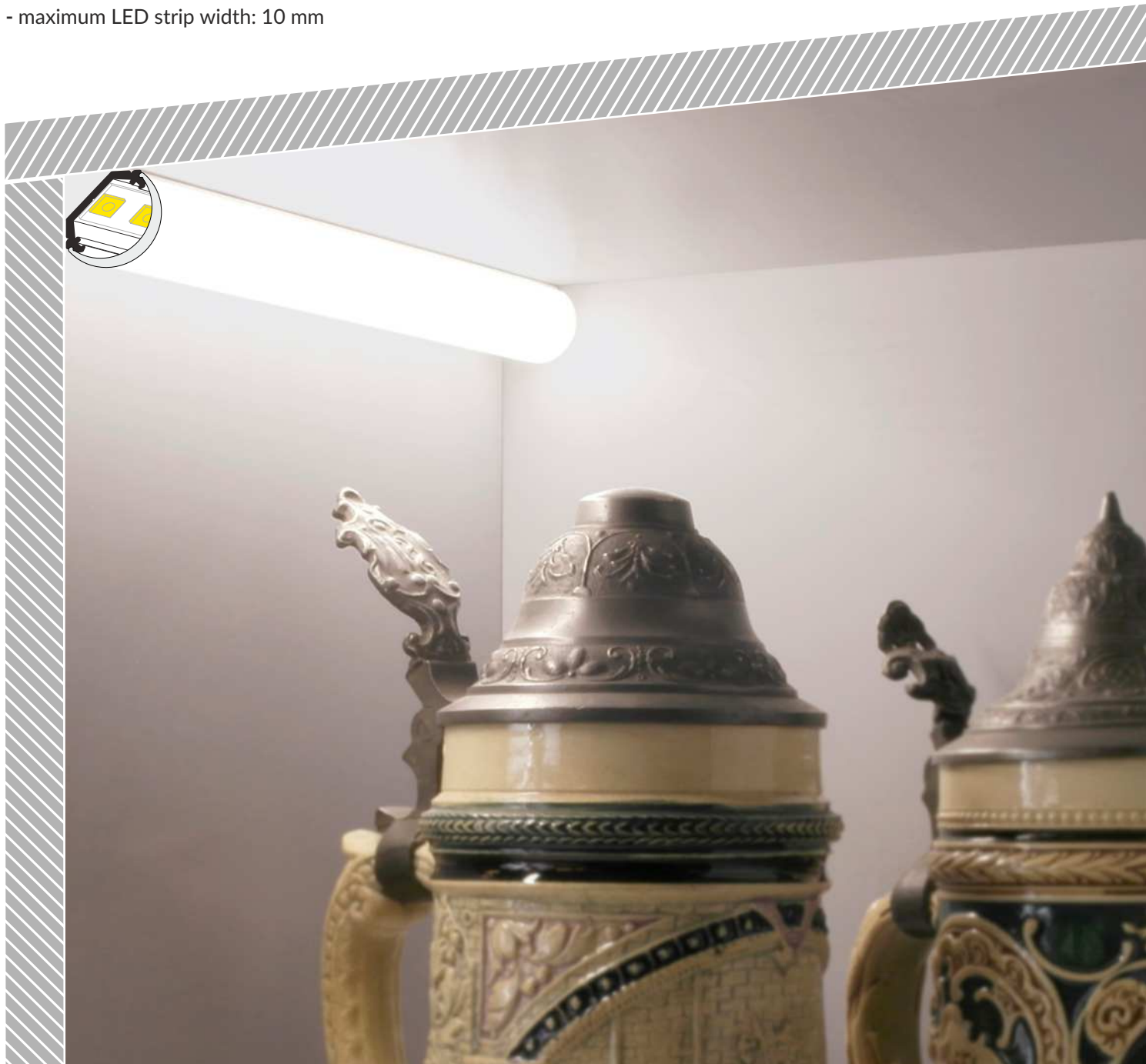

ÄHNLICHES IM ANGEBOT / SIMILAR IN THE OFFER



TRIO10
BC



CORNER10
BC/UX



CABI12
E



CORNER14
EF/TY



CORNER27
G/UX



B Abdeckung **B** einziehbar
B slide cover

D Abdeckung **D** einclipsbar
D click cover

U6¹ Halter **U6**
U6 mounting plate

U6² Halter **U6** cone
cone U6 mounting plate

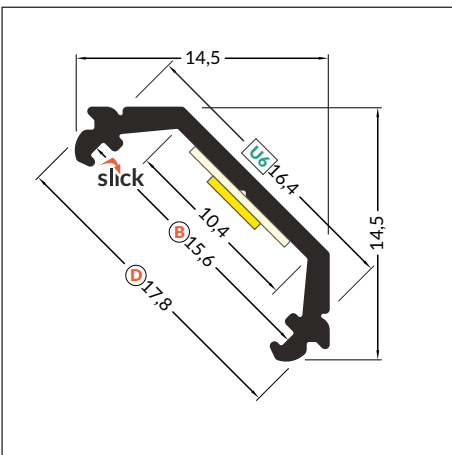
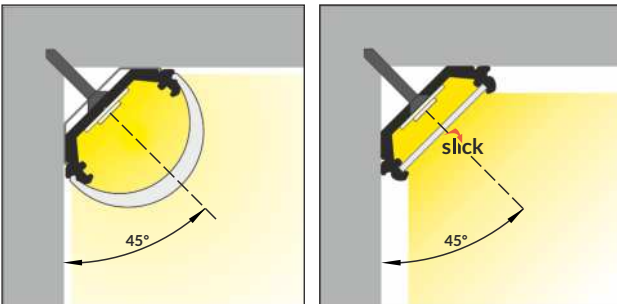
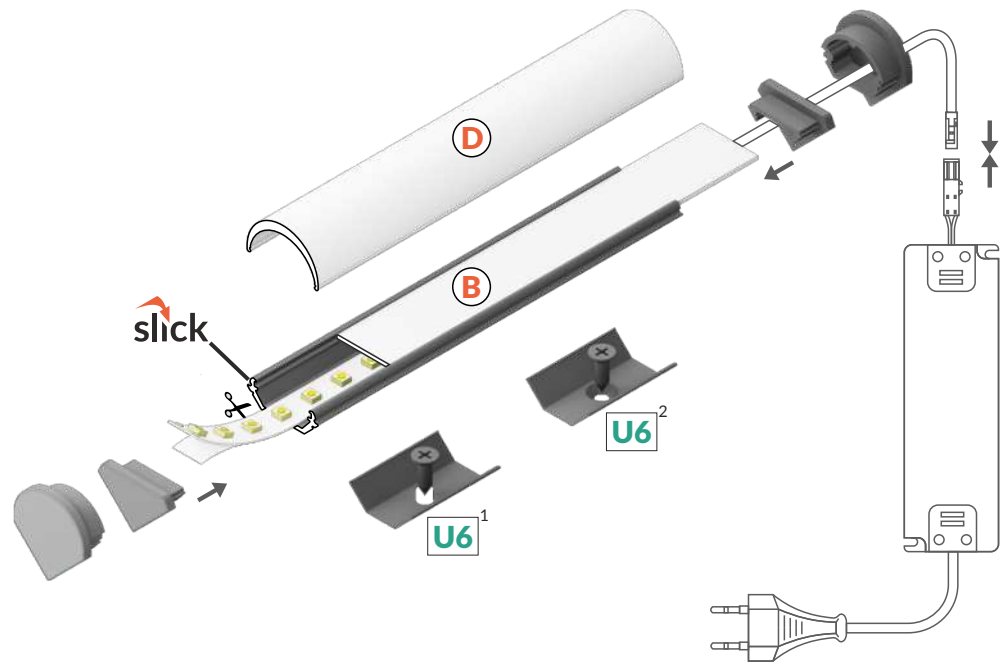

 max 10 mm

 Eckprofile
corner

Artikelnummer = 1 Stück,
Länge 2.000 mm,
INDEX = 1 pc, length 2000 mm

eloxiert
anodized
95D3020020

Die zugänglichen Längen: 1000 mm, 2000 mm, 3000 mm, 4000 mm.
Die standardmäßige Toleranz der Länge von Profilen beträgt: +20 mm.
Mehr Informationen >> 1.08.

Available lengths: 1000 mm, 2000 mm, 3000 mm, 4000 mm.
The standard profile length tolerance is +20 mm.
More details >> 1.08.



ABDECKUNG / COVERS

Abdeckung **B** einziehbar
Farben: transparent, satiniert, opal
Material: PC, PP, PP

B slide cover
colours: transparent, frosted, opal
material: PC, PP, PP

Abdeckung **D** einclipbar
Farben: opal
Material: PMMA

D slide cover
colours: opal
material: PMMA



Achtung! Die Abmessungen des Platzes für die Montage von LED Lichtquelle
Note! Dimensions of the space to install LED source

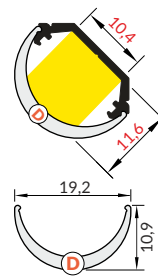
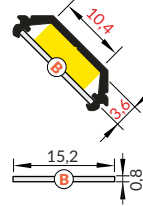

Länge 2.000 mm,
length 2000 mm

B transparent
Artikelnummer = 10 Stück
index = 10 pcs
9576250016

B satiniert / B frosted
Artikelnummer = 10 Stück
index = 10 pcs
9576250039

B opal
Artikelnummer = 10 Stück
index = 10 pcs
9576250038

D opal
Artikelnummer = 1 Stück
index = 1 pcs
95A1140038

Die Toleranz der Länge von Abdeckungen beträgt: +20 mm.
Mehr Informationen >> 1.08.
The standard cover length tolerance is +20 mm.
More details >> 1.08.

ENDKAPPEN / ENDINGS

Endkappe QUARTER10
Farben: silbern, grau
Material: ABS
QUARTER10 ending
colours: silver, grey
material: ABS

Endkappe QUARTER10 D
Farben: silbern, grau
Material: ABS
QUARTER10 D ending
colours: silver, grey
material: ABS



Die Endkappe mit Punkten für das Bohren von Öffnungen.
Ending with marked space to bore the holes.

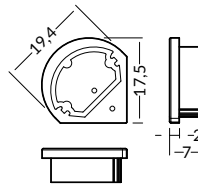
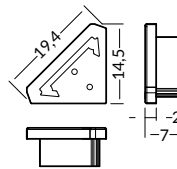

Artikelnummer = 10 Sets = 20 Stück
INDEX = 10 sets = 20 pcs

silbern / silver
95D3980040
grau / grey
95D3980022

silbern / silver
95D3990040
grau / grey
95D3990022

HALTER / MOUNTINGS

Halter **U6**
Farben: inox
Material: rostfreier Stahl
U6 mounting plate
colours: inox
material: stainless steel

Halter **U6** cone
Farben: inox
Material: rostfreier Stahl
cone **U6** mounting plate
colours: inox
material: stainless steel

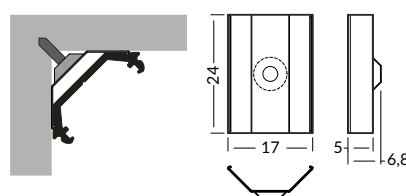
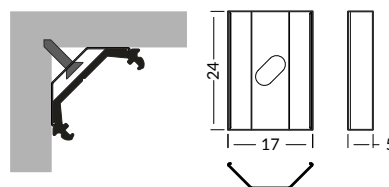

Artikelnummer = 10 Sets = 20 Stück
INDEX = 10 sets = 20 pcs

inox
95D3960019

inox
95D3970019



EIN PROFIL FÜR DIE BELEUCHTUNG DES INNEREN DER VITRINE VERTIKAL UND HORIZONTAL

A PROFILE FOR SHOW CASE'S INSIDE VERTICAL AND HORIZONTAL ILLUMINATION

- zwei Leuchtwinkel 30° und 60°
- kleine Größe, keine Halter und ein Kabeldurchführungskanal - minimaler Eingriff in das Aussehen der Vitrine
- Sockel mit Slick Funktion
- maximale Breite des LED Streifens 12 mm
- two lighting angles: 30°/60°
- small sizes, no holders and a channel for hiding cables - minimum interference in glass show case's look
- Slick socket
- maximum LED strip width: 12 mm

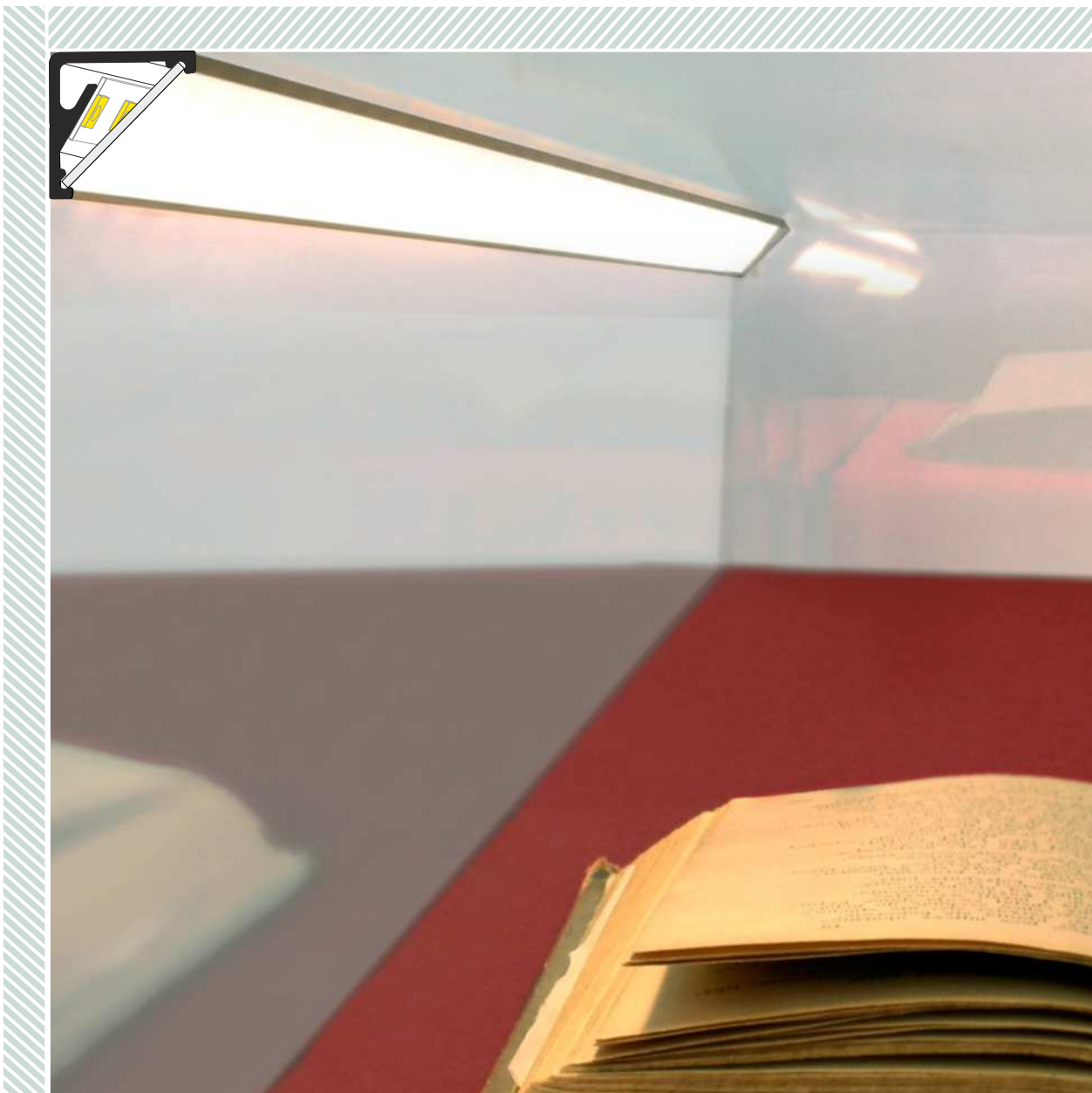

ÄHNLICHES IM ANGEBOT / SIMILAR IN THE OFFER





E Abdeckung **E** einziehbar
E slide cover

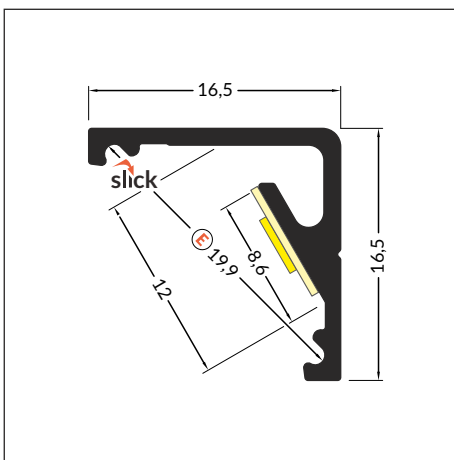
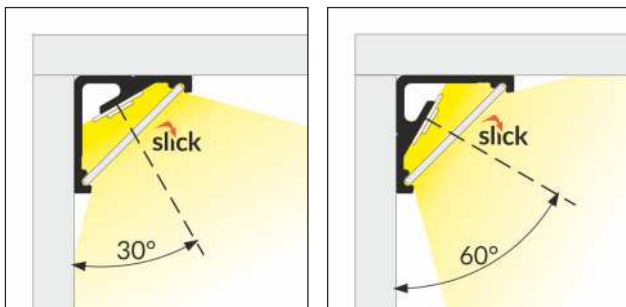
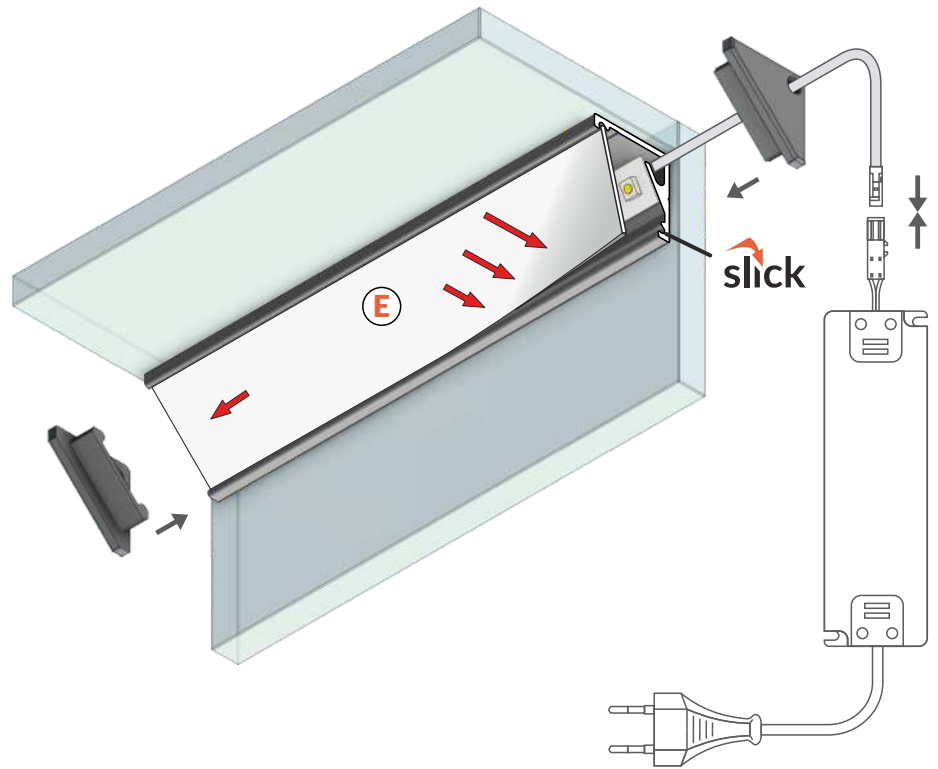

 max 12 mm

 Eckprofile
 corner



Artikelnummer = 1 Stück,
 Länge 2.000 mm,
 INDEX = 1 pc, length 2000 mm

weiß lackiert
 white painted
95C9020001



eloxiert
 anodized
95C9020020



schwarz eloxiert
 black anodized
95C9020021



Rohaluminium
 raw aluminium
95C9020000

Die zugänglichen Längen: 1000 mm, 2000 mm.
 Die standardmäßige Toleranz der Länge von Profilen beträgt: +20 mm.
 Mehr Informationen >> 1.08.

Available lengths: 1000 mm, 2000 mm.
 The standard profile length tolerance is +20 mm.
 More details >> 1.08.



ABDECKUNG / COVERS

Abdeckung **E** einziehbar
Farben: transparent, satiniert, opal
Material: PC, PP, PP

E slide cover
colours: transparent, frosted, opal
material: PC, PP, PP



Achtung! Die Abmessungen des Platzes für die Montage von LED Lichtquelle
Note! Dimensions of the space to install LED source

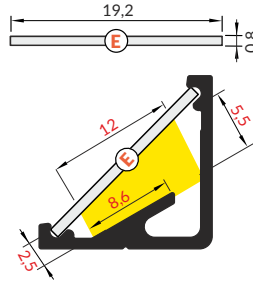

Länge 2.000 mm,
length 2000 mm

E transparent
Artikelnummer = 10 Stück
index = 10 pcs
95A2040016

E satiniert / E frosted
Artikelnummer = 10 Stück
index = 10 pcs
95A2040039

E opal
Artikelnummer = 10 Stück
index = 10 pcs
95A2040038

Die Toleranz der Länge von Abdeckungen beträgt: +20 mm.
Mehr Informationen >> 1.08.

The standard cover length tolerance is +20 mm.
More details >> 1.08.

ENDKAPPEN / ENDINGS

Endkappe CABI12
Farben: weiß, silbern, schwarz, grau
Material: ABS
CABI12 ending
colours: white, silver, black, grey
material: ABS

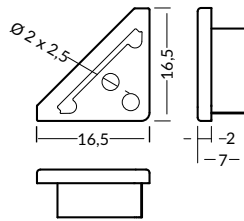

Die Endkappe mit Punkten für das Bohren von Öffnungen.
Ending with marked space to bore the holes.

Artikelnummer = 10 Sets = 20 Stück
INDEX = 10 sets = 20 pcs

weiß / white
95C9980001

silbern / silver
95C9980040

schwarz / black
95C9980002

grau / grey
95C9980022



UNSICHTBARE KABEL

Ein Kabeldurchführungskanal ermöglicht das ästhetische Aussehen der Vitrine zu bewahren.

INVISIBLE WIRES

Special channel to hide the wires allows to remain esthetic look of the showcase.



GLEICHE SEITENLÄNGE

Ein symmetrischer Profilaufbau ermöglicht eine präzise Verbindung in unterschiedlichen Konfigurationen.

EQUAL SIDE LENGTHS

The symmetrical profile design allows precise connections in a different configurations.

CORNER14 EF/TY

ECKPROFIL 30°/60°

ANGULAR PROFILE 30°/60°

- dekorativ-beleuchtendes Profil
- eine versteckte Befestigung
- zwei Leuchtwinkel 30° und 60°
- maximale Breite des LED Streifens 14 mm

- decorative and lighting profile
- hidden mounting
- two lighting angles: 30°/60°
- maximum LED strip width: 14 mm



ÄHNLICHES IM ANGEBOT / SIMILAR IN THE OFFER



TRIO10
BC



CORNER10
BC/UX



QUARTER10
BD/U6



CABI12
E



CORNER27
G/UX



- E** Abdeckung E einschiebbar
E slide cover
- F** Abdeckung F einclipsbar
F click cover
- E7** Abdeckung E7 einclipsbar
E7 click cover
- Y¹** Halter Y flexibel
Y flexible mounting plate
- Y²** Halter Y flexibel cone
cone Y flexible mounting plate
- T** Halter T
T mounting plate

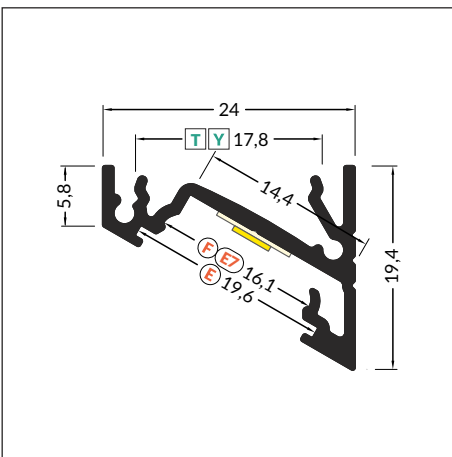
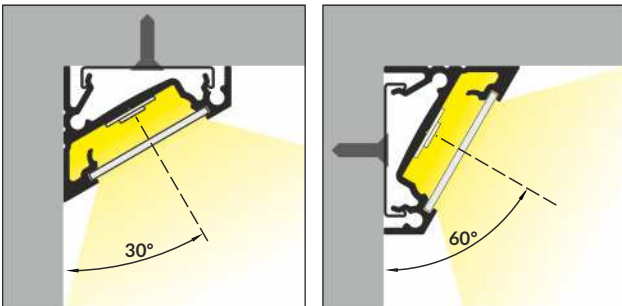
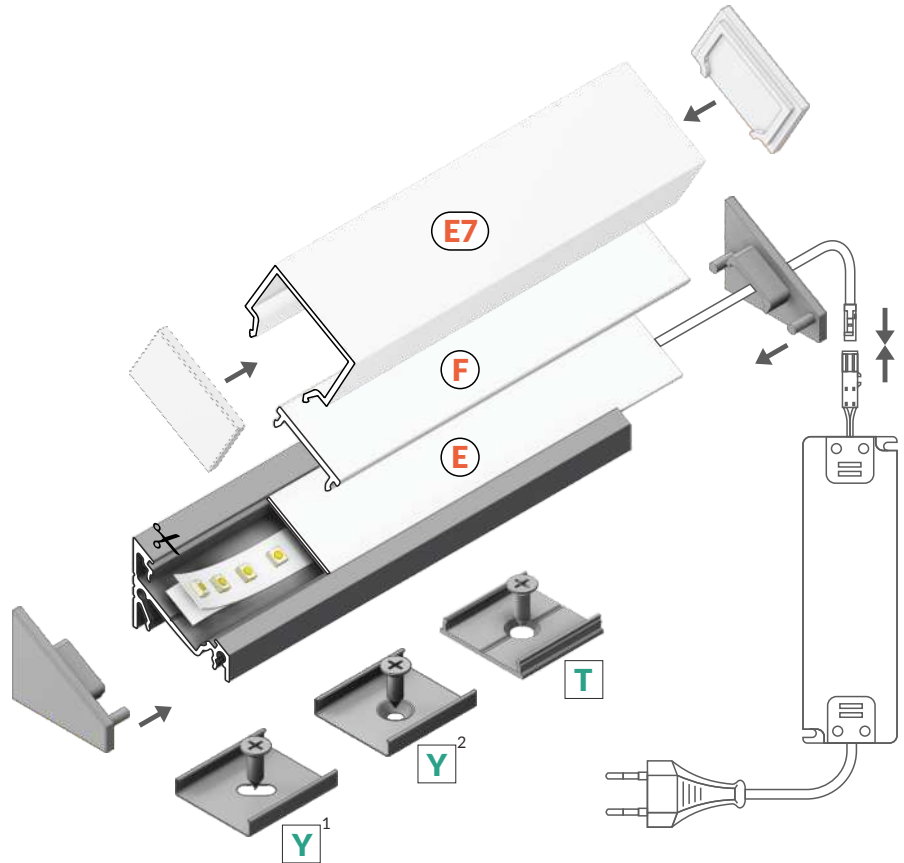

 max 14 mm

 Eckprofile
corner



Artikelnummer = 1 Stück,
Länge 2.000 mm,
INDEX = 1 pc, length 2000 mm

weiß lackiert
white painted
95A4020001

eloxiert
anodized
95A4020020

schwarz eloxiert
black anodized
95A4020021

Rohaluminium
raw aluminium
95A4020000

Die zugänglichen Längen: 1000 mm, 2000 mm, 3000 mm, 4000 mm.
Die standardmäßige Toleranz der Länge von Profilen beträgt: +20 mm.
Mehr Informationen >> 1.08.

Available lengths: 1000 mm, 2000 mm, 3000 mm, 4000 mm.
The standard profile length tolerance is +20 mm.
More details >> 1.08.



ABDECKUNG / COVERS

Abdeckung E einziehbar
Farben: transparent, satiniert, opal
Material: PC, PP, PP

E slide cover
colours: transparent, frosted, opal
material: PC, PP, PP



Achtung! Die Abmessungen des Platzes für die Montage von LED Lichtquelle
Note! Dimensions of the space to install LED source

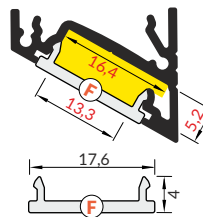
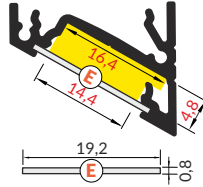

Abdeckung F einclipsbar
Farben: transparent, opal
Material: PMMA

F click cover
colours: transparent, opal
material: PMMA

Abdeckung E7 einclipsbar
Farben: opal
Material: PMMA

E7 click cover
colours: opal
material: PMMA

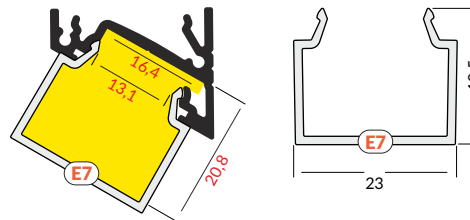

NEU

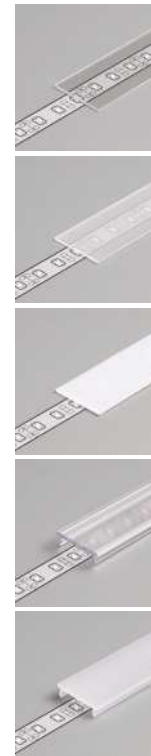
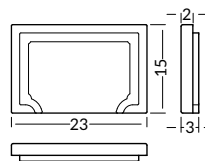

Länge 2.000 mm,
length 2000 mm

E transparent
Artikelnummer = 10 Stück
index = 10 pcs
95A2040016

E satiniert / E frosted
Artikelnummer = 10 Stück
index = 10 pcs
95A2040039

E opal
Artikelnummer = 10 Stück
index = 10 pcs
95A2040038

F transparent
Artikelnummer = 1 Stück
index = 1 pc
95A2060016

F opal
Artikelnummer = 1 Stück
index = 1 pc
95A2060038

Rolle, Länge 20 m,
reel, length 20 m

F opal
Artikelnummer = 1 Stück
index = 1 pc
95A2210038S

Länge 2.000 mm,
length 2000 mm

E7 opal
Artikelnummer = 1 Stück
index = 1 pc
95C1080038

Die Toleranz der Länge von Abdeckungen beträgt: +20 mm.
Mehr Informationen >> 1.08.
The standard cover length tolerance is +20 mm.
More details >> 1.08.

Artikelnummer = 1 Set = 2 Stück
INDEX = 1 set = 2 pcs

Endkappe E7 opal
E7 opal ending
95C1840038

HALTER / MOUNTINGS

Halter Y flexibel
Farben: inox
Material: rostfreier Stahl
Y flexible mounting plate
colours: inox
material: stainless steel

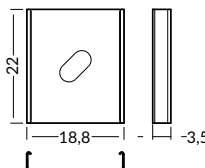
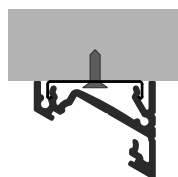

Halter Y flexibel cone
Farben: inox
Material: rostfreier Stahl
cone Y flexible mounting plate
colours: inox
material: stainless steel

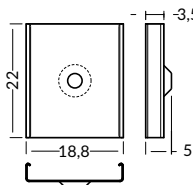
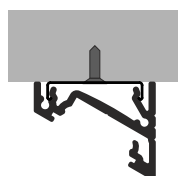

Artikelnummer = 10 Sets = 20 Stück
INDEX = 10 sets = 20 pcs

inox
95A2090019

inox
95A2130019



HALTER / MOUNTINGS

Halter T
Farben: Rohaluminium
Material: Aluminium

T mounting plate
colours: raw aluminium
material: aluminium

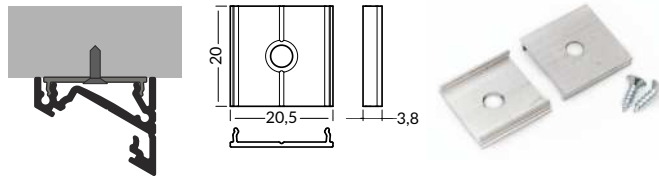

Artikelnummer = 10 Sets = 20 Stück
INDEX = 10 sets = 20 pcs

Rohaluminium
raw aluminium
95C696000

ENDKAPPEN / ENDINGS

Endkappe CORNER14 gen2
Farben: weiß, silbern, schwarz, grau
Material: ABS
endings CORNER14 gen2
colours: white, silver, black, grey
material: ABS

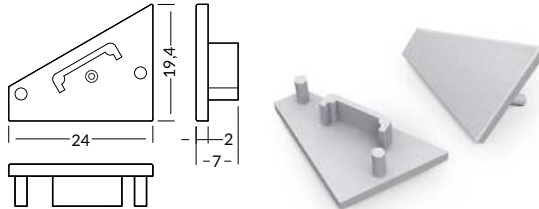

Artikelnummer = 10 Sets = 20 Stück
INDEX = 10 sets = 20 pcs

weiß / white
95A4980001
silbern / silver
95A4980040
schwarz / black
95A4980002
grau / grey
95A4980022

Endkappe CORNER14 gen2 mit Öffnung
Farben: weiß, silbern, schwarz, grau
Material: ABS
endings CORNER14 gen2 with hole
colours: white, silver, black, grey
material: ABS

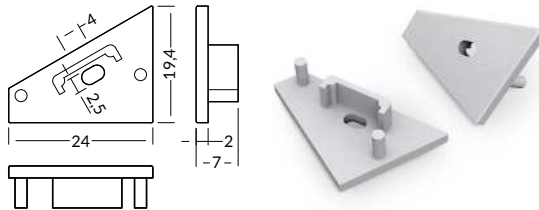

weiß / white
95A4970001
silbern / silver
95A4970040
schwarz / black
95A4970002
grau / grey
95A4970022

VERBINDUNGSTÜCKE / CONNECTORS

Verbindungsstück T 180 Grad
Farben: Rohaluminium
Material: Aluminium
T connector 180 deg
colour: raw aluminium
material: aluminium

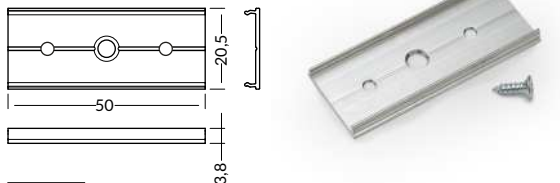

Artikelnummer = 1 Set
INDEX = 1 set

Rohaluminium
raw aluminium
95C6990000

Verbinder 90 Grad für CORNER14
Farben: weiß, eloxiert, schwarz
Material: Aluminium
CORNER14 connector 90 deg
colours: white, anodized, black
material: aluminium

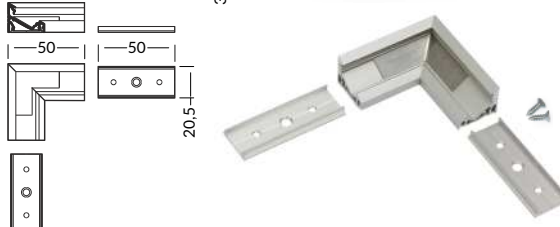

weiß lackiert
white painted
95A4990001
eloxiert
anodized
95A4990020

schwarz eloxiert
black anodized
95A4990021



CORNER27 G/UX

EIN GROßES ECKPROFIL

LARGE-SIZE ANGULAR PROFILE

- Beleuchtungsprofil - Möglichkeit eine hohe Effizienz zu erreichen
- eine versteckte Befestigung
- zwei Leuchtwinkel 30° und 60°
- maximale Breite des LED Streifens: 27 mm oder bis drei Standardstreifen mit 8 mm Breite
- lighting profile - possibility of high lumen output
- hidden mounting
- two lighting angles: 30° or 60°
- maximum LED strip width: 27 mm or 3 standard strips (8 mm)



ÄHNLICHES IM ANGEBOT / SIMILAR IN THE OFFER



TRIO10
BC



CORNER10
BC/UX



QUARTER10
BD/U6



CABI12
E



CORNER14
EF/TY



G Abdeckung **G** einschiebbar
G slide cover

U¹ Halter **U** flexibel
U flexible mounting plate

U² Halter **U** flexibel cone
cone **U** flexible mounting plate

X¹ Halter **X**
X mounting plate

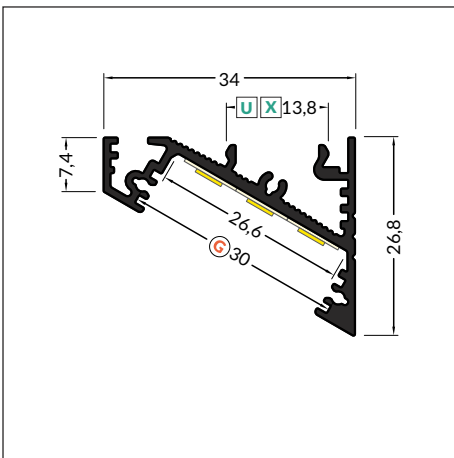
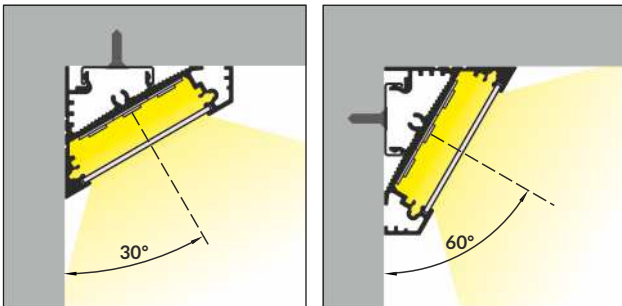
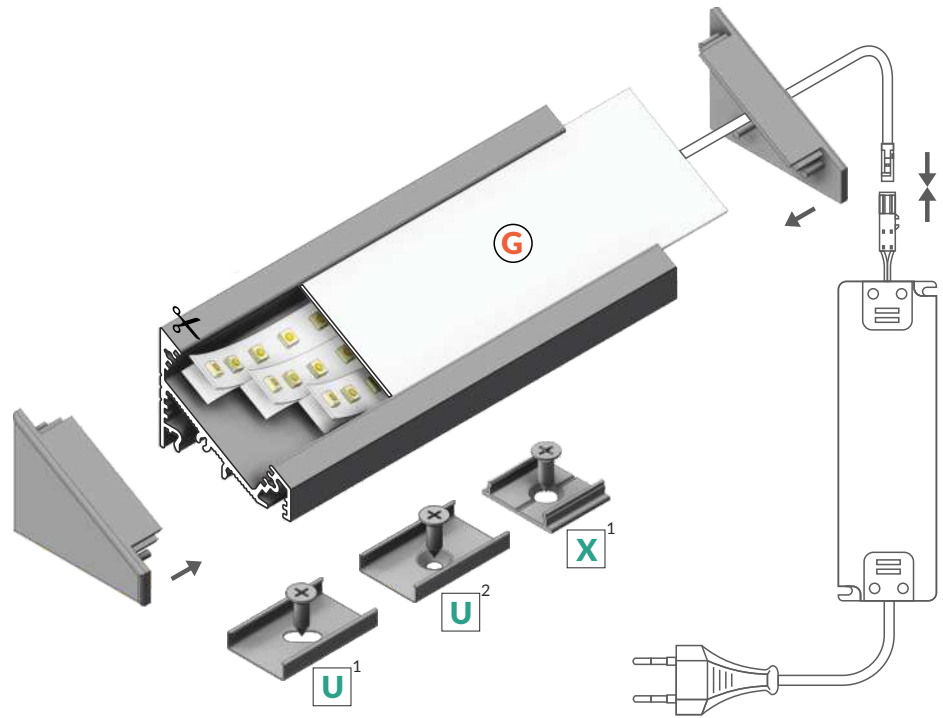

 max 27 mm

 Eckprofile
corner



Artikelnummer = 1 Stück,
Länge 2.000 mm,
INDEX = 1 pc, length 2000 mm

weiß lackiert
white painted
9598030001



eloxiert
anodized
9598030020



schwarz eloxiert
black anodized
9598030021

Die zugänglichen Längen: 1000 mm, 2000 mm, 3000 mm, 4000 mm.
Die standardmäßige Toleranz der Länge von Profilen beträgt: +20 mm.
Mehr Informationen >> 1.08.

Available lengths: 1000 mm, 2000 mm, 3000 mm, 4000 mm.
The standard profile length tolerance is +20 mm.
More details >> 1.08.



ABDECKUNG / COVERS

Abdeckung **G** einschiebbar
Farben: transparent, satiniert, opal
Material: PC, PP, PP

G slide cover
colours: transparent, frosted, opal
material: PC, PP, PP



Achtung! Die Abmessungen des Platzes für die Montage von LED Lichtquelle
Note! Dimensions of the space to install LED source

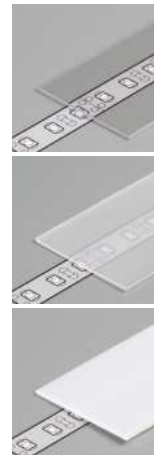
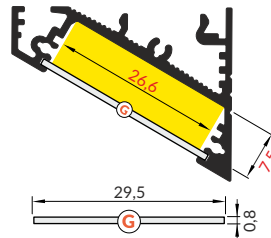

Länge 2.000 mm,
length 2000 mm

G transparent
Artikelnummer = 10 Stück
index = 10 pcs
9584070016

G satiniert / G frosted
Artikelnummer = 10 Stück
index = 10 pcs
9584070039

G opal
Artikelnummer = 10 Stück
index = 10 pcs
9584070038

Die Toleranz der Länge von Abdeckungen beträgt: +20 mm.
Mehr Informationen >> 1.08.

The standard cover length tolerance is +20 mm.
More details >> 1.08.

ENDKAPPEN / ENDINGS

Endkappe CORNER27
Farben: weiß, silbern, schwarz, grau
Material: ABS

endings CORNER27
colours: white, silver, black, grey
material: ABS

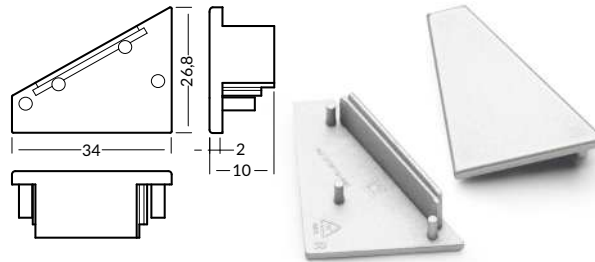

Artikelnummer = 10 Sets = 20 Stück
INDEX = 10 sets = 20 pcs

weiß / white
9598050001

silbern / silver
9598050040

schwarz / black
9598050002

grau / grey
9598050022

HALTER / MOUNTINGS

Halter **U** flexibel
Farben: inox
Material: rostfreier Stahl

U flexible mounting plate
colours: inox
material: stainless steel

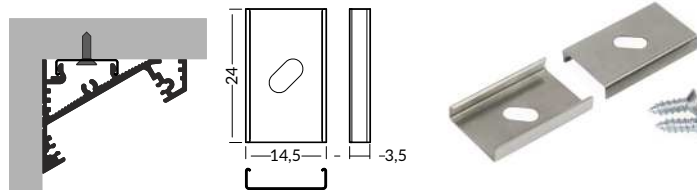

Halter **U** flexibel cone
Farben: inox
Material: rostfreier Stahl

cone **U** flexible mounting plate
colours: inox
material: stainless steel

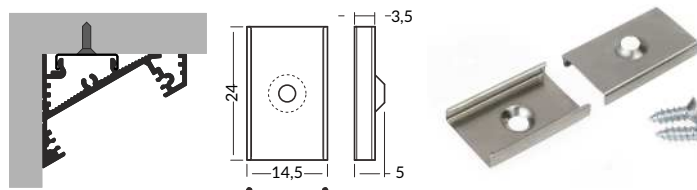

Artikelnummer = 10 Sets = 20 Stück
INDEX = 10 sets = 20 pcs

inox
9576380000

inox
9576620000

Halter **X**
Farben: Rohaluminium
Material: Aluminium

X mounting plate
colours: raw aluminium
material: aluminium

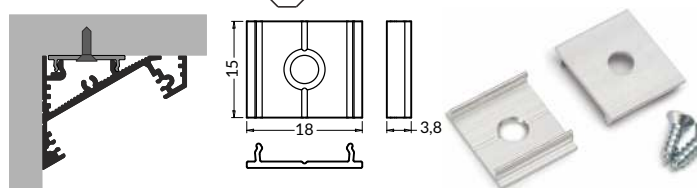

Rohaluminium
raw aluminium
9576260000



VERBINDUNGSTÜCKE / CONNECTORS

Verbindungsstück X 180 Grad
Farben: Rohaluminium
Material: Aluminium

X connector 180 deg
colour: raw aluminium
material: aluminium

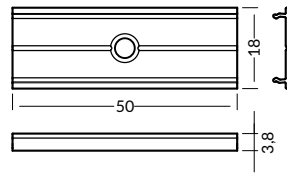

Artikelnummer = 1 Set
INDEX = 1 set

Rohaluminium
raw aluminium
9576350000



PEN8 |

EIN UNIVERSELLES ALUMINIUMPROFIL

MULTI-PURPOSE ALUMINIUM PROFILE

- ein dekorativ-beleuchtendes Profil, z.B. für Glasvitrinen
 - neun Befestigungsmöglichkeiten: für die vertikale oder horizontale Beleuchtung (auch mit Verstellmöglichkeit des Lichtkegels)
 - die Möglichkeit der Montage zwischen den Wänden
 - maximale Breite des LED Streifens 8 mm
-
- decorative and lighting profile, eg. for glass cabinets
 - 9 types of mountings: for horizontal or vertical lighting (also with adjustment)
 - possibility of mounting between the walls of a cabinet
 - maximum LED strip width: 8 mm

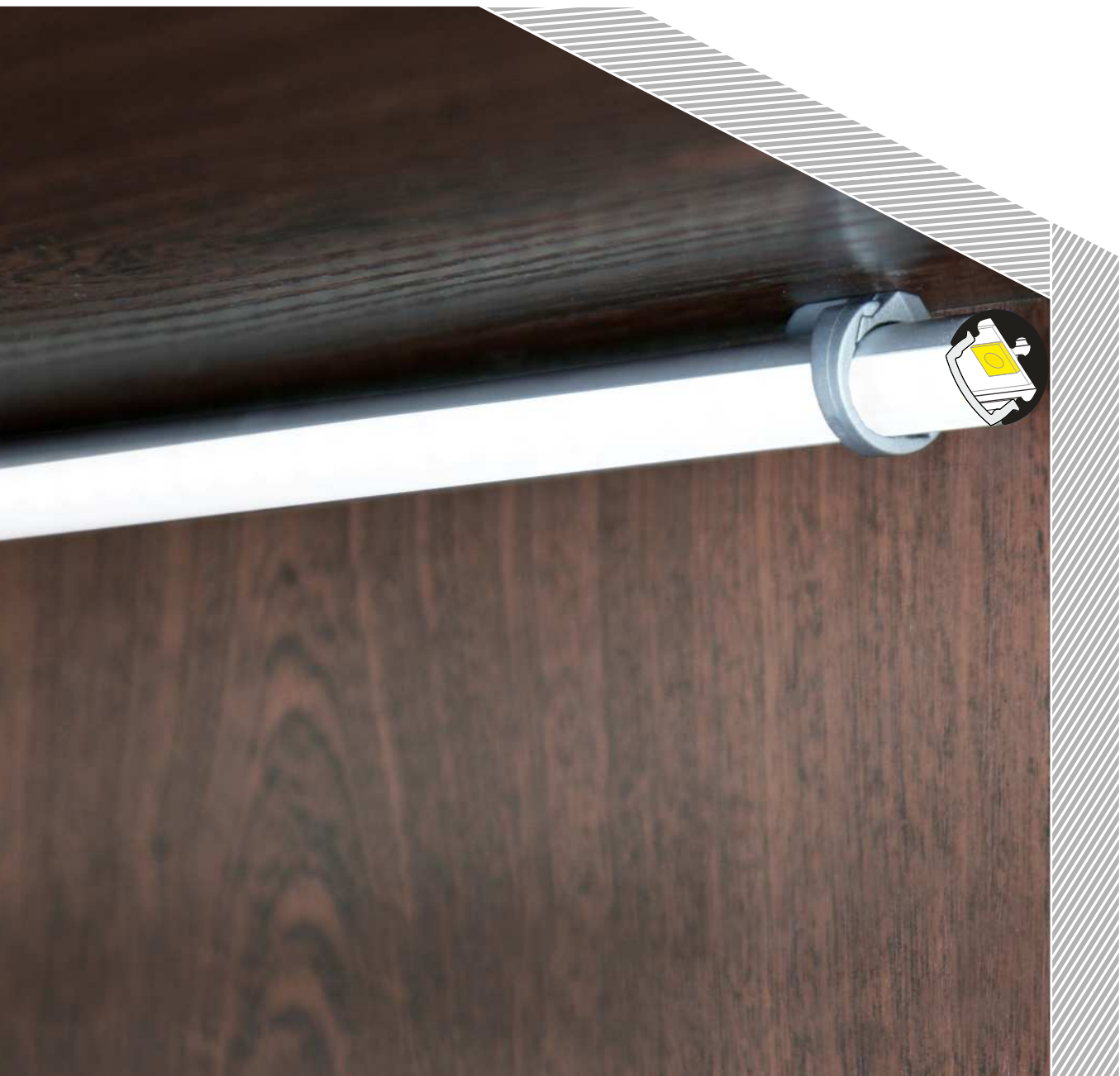

ÄHNLICHES IM ANGEBOT / SIMILAR IN THE OFFER



PEN12
CJ



CABI12
E



CORNER10
BC/UX



TRIO10
BC



OVAL20
BC



I Abdeckung | einclipsbar
| click cover

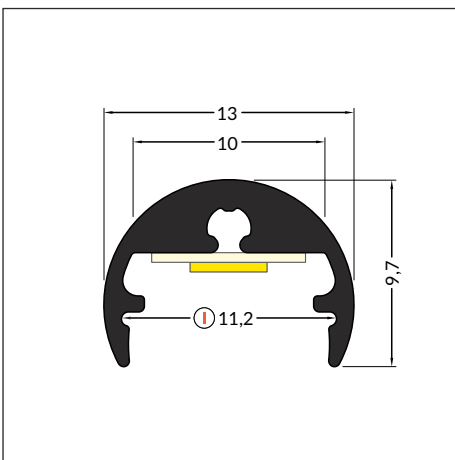
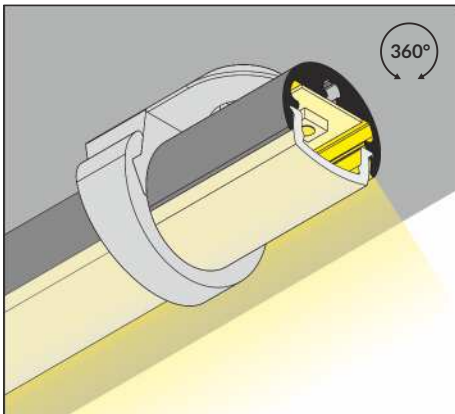
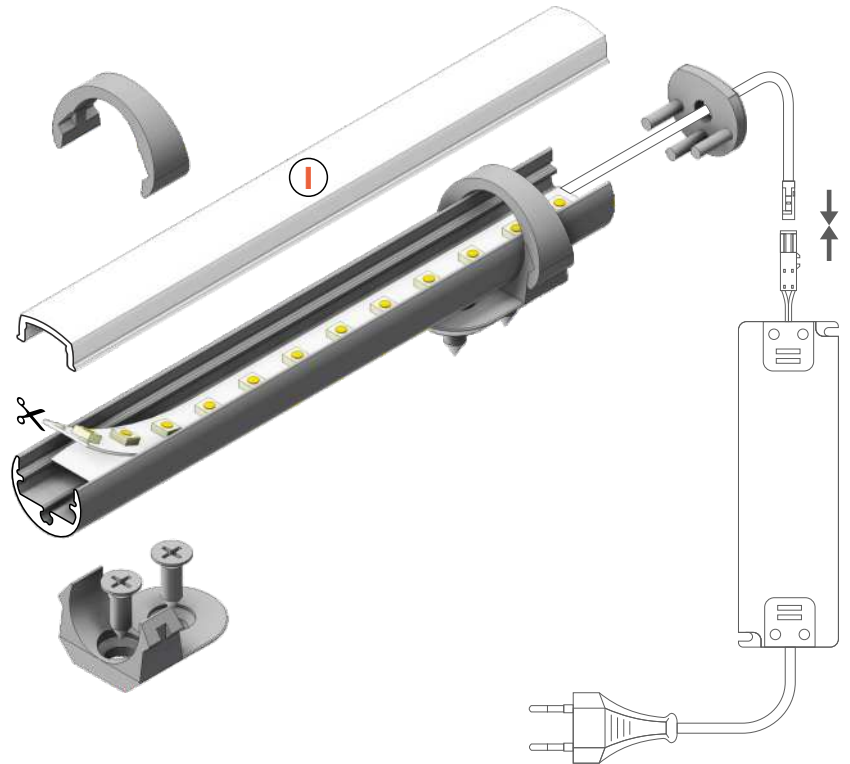

max 8 mm



spezielle Profile
special application

Artikelnummer = 1 Stück,
Länge 2.000 mm,
INDEX = 1 pc, length 2000 mm

eloxiert
anodized

9586030020

Die zugänglichen Längen: 1000 mm, 2000 mm, 3000 mm, 4000 mm.
Die standardmäßige Toleranz der Länge von Profilen beträgt: +20 mm.
Mehr Informationen >> 1.08.

Available lengths: 1000 mm, 2000 mm, 3000 mm, 4000 mm.
The standard profile length tolerance is +20 mm.
More details >> 1.08.



ABDECKUNG / COVERS

Abdeckung | einclipsbar
Farben: satiniert, opal
Material: PMMA

| click cover
colours: frosted, opal
material: PMMA



Achtung! Die Abmessungen des Platzes für die Montage von LED Lichtquelle
Note! Dimensions of the space to install LED source

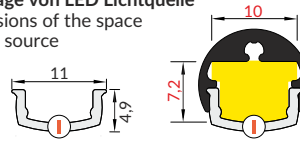

Länge 2.000 mm,
length 2000 mm

| satiniert / | frosted
Artikelnummer = 1 Stück
index = 1 pc
9586060000

| opal
Artikelnummer = 1 Stück
index = 1 pc
9586060038

Die Toleranz der Länge von Abdeckungen beträgt: +20 mm.
Mehr Informationen >> 1.08.

The standard cover length tolerance is +20 mm.
More details >> 1.08.

ENDKAPPEN / ENDINGS

Endkappe PEN8
Farben: silbern, grau
Material: ABS

PEN8 ending
colours: silver, grey
material: ABS

Endkappe PEN8 mit Öffnung
Farben: silbern, grau
Material: ABS

PEN8 ending with hole
colours: silver, grey
material: ABS

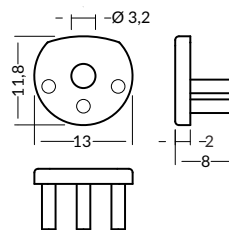

Artikelnummer = 1 Set,
INDEX = 1 set

silbern / silver
9586490040
grau / grey
9586490022

silbern / silver
9586470040
grau / grey
9586470022

HALTER / MOUNTINGS

Halter PEN8 flach
Farben: grau
Material: ABS

PEN8 flat holder
colour: grey
material: ABS

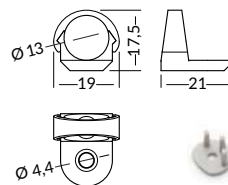
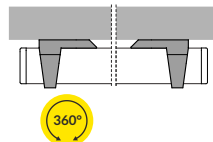

Artikelnummer = 10 Sets = 20 Stück
INDEX = 10 sets = 20 pcs

grau / grey
9586070022

Artikelnummer = 1 Set = 2 Stück
INDEX = 1 set = 2 pcs

Halter PEN8 einfach
Material: verzinkter Stahl

PEN8 simple holder
material: zinc coated steel

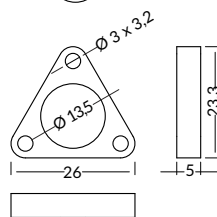
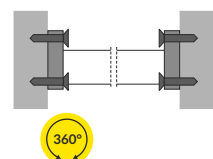

verzinkt
zinc coated
9586370030

Montagering PEN8
Farben: Chrom
Material: Messing

PEN8 ring holder
colours: chrome
material: brass

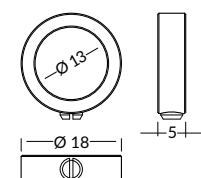
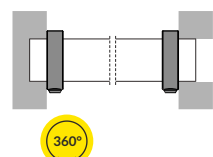

Chrom
chrome
9586440003

Dübelhalter PEN8
Farben: Chrom
Material: Messing

PEN8 stretcher holder
colour: chrome
material: brass

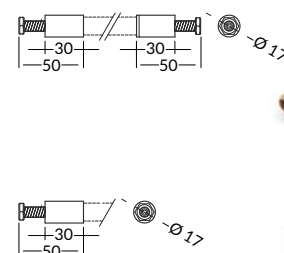
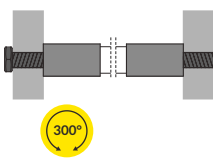

Chrom
chrome
9586290003

Artikelnummer = 1 Set = 1 Stück
INDEX = 1 set = 1 pc

Endhalter PEN8
Farben: Chrom
Material: Messing

PEN8 end holder
colour: chrome
material: brass

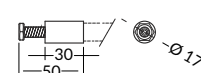
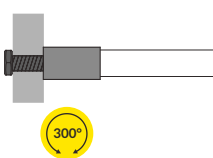

Chrom
chrome
9586160003



HALTER / MOUNTINGS

Gelenkhalter mit Deckenhalter für PEN8

Farben: Chrom
Material: Stahl, Messing

PEN8 jointed holder with soffit ceiling
colour: chrome
material: steel, brass

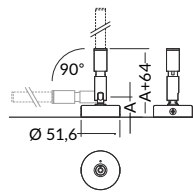

Doppelhalter mit Gewinde für PEN8

Farben: Chrom
Material: Stahl, Messing

PEN8 double holder with thread
colour: chrome
material: steel, brass

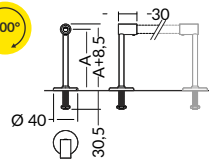

Doppelhalter mit Deckenhalter für PEN8

Farben: Chrom
Material: Stahl, Messing

PEN8 double holder with soffit ceiling
colour: chrome
material: steel, brass

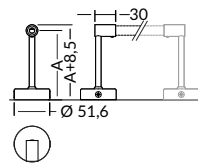

Artikelnummer = 1 Set = 1 Stück
INDEX = 1 set = 1 pc

A =

27 mm	9586080003
100 mm	9586300003
200 mm	9586100003
300 mm	9586120003

Artikelnummer = 1 Set = 2 Stück
INDEX = 1 set = 2 pcs

A =

100 mm	9586330003
200 mm	9586180003
300 mm	9586200003

Artikelnummer = 1 Set = 2 Stück
INDEX = 1 set = 2 pcs

A =

100 mm	9586320003
200 mm	9586170003
300 mm	9586190003

Photo: / Photo:
PORSA - Systemy Meblowe Mirosław Krysiak



BACK10 A/UX

ZWEI ABSTRAHLRICHTUNGEN

TWO LIGHTING DIRECTIONS

- **dekorative Beleuchtung**
 - **Konstruktion in der Form des Buchstabens "T"** ermöglicht den Lichtkegel in zwei Richtungen auszurichten (oben/unten, rechts/links)
 - **Befestigung mit Hilfe von speziellen Haltern (an die Wand) oder direkt mit Hilfe der Schrauben (an ein Möbelstück)**
 - **eine optionale Anwendung der Abdeckung A**
 - **maximale Breite des LED Streifens 10 mm**
-
- decorative illumination
 - the T-shaped structure makes possible to direct the light beam in two directions (up/down, left/right)
 - mounting with two dedicated holders (to the wall) or directly to the piece of furniture, using screws
 - optionally, the A cover can be used
 - maximum LED strip width: 10 mm

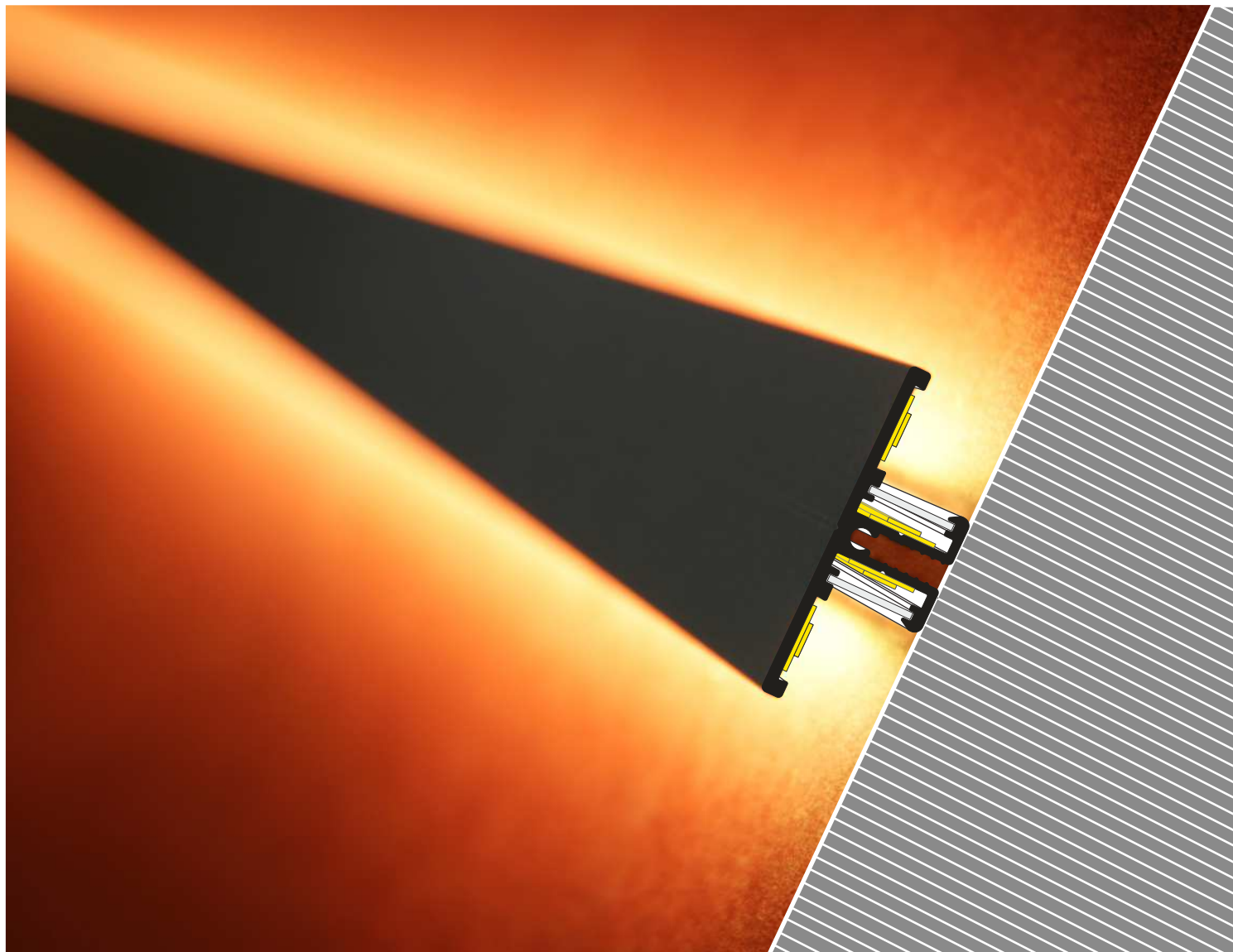

ÄHNLICHES IM ANGEBOT / SIMILAR IN THE OFFER



TWIN8



WALLE12
CD



- A** Abdeckung **A** einschiebbar
A slide cover
- U**¹ Halter **U** flexibel
U flexible mounting plate
- U**² Halter **U** flexibel cone
cone U flexible mounting plate
- X**¹ Halter **X**
X mounting plate

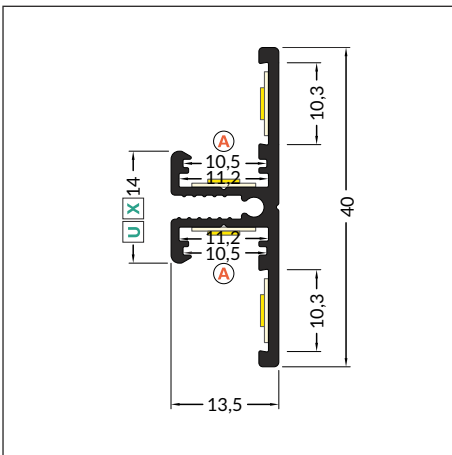
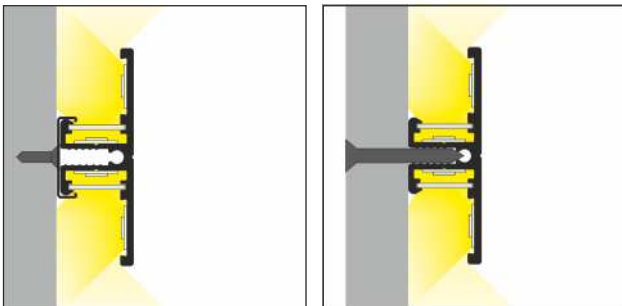
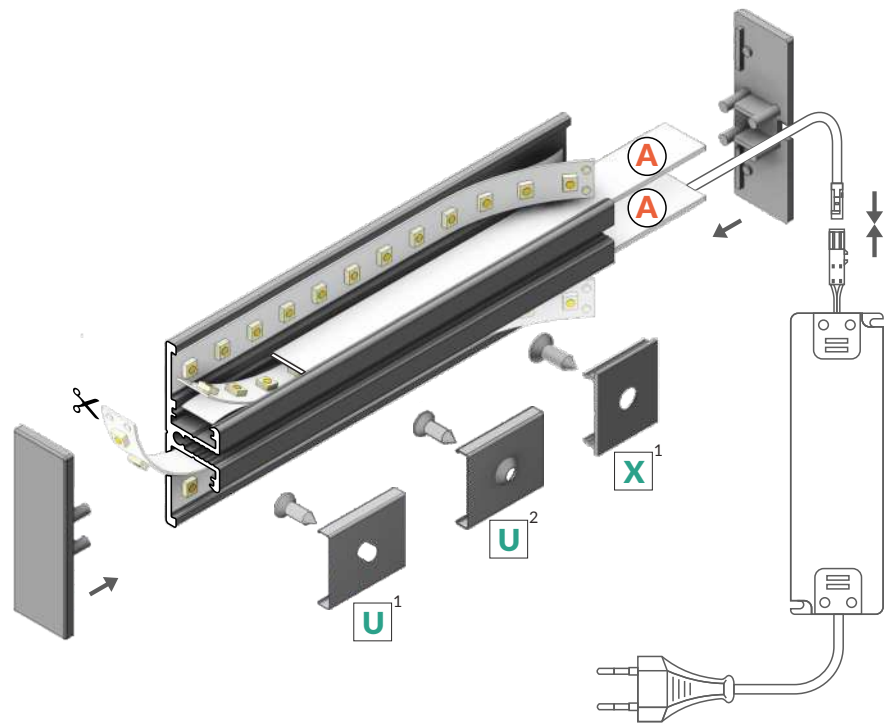

max 10 mm



spezielle Profile
special application



Artikelnummer = 1 Stück,
Länge 2.000 mm,
INDEX = 1 pc, length 2000 mm

weiß lackiert
white painted
9590030001

eloxiert
anodized
9590030020

schwarz lackiert
black painted
9590030002

Rohaluminium
raw aluminium
9590030000

Die zugänglichen Längen: 1000 mm, 2000 mm, 3000 mm, 4000 mm.
Die standardmäßige Toleranz der Länge von Profilen beträgt: +20 mm.
Mehr Informationen >> 1.08.

Available lengths: 1000 mm, 2000 mm, 3000 mm, 4000 mm.
The standard profile length tolerance is +20 mm.
More details >> 1.08.



ABDECKUNG / COVERS

Abdeckung **A** einziehbar
Farben: transparent, satiniert, opal
Material: PC, PP, PP

A slide cover
colours: transparent, frosted, opal
material: PC, PP, PP

Achtung! Die Abmessungen
des Platzes für die Montage
von LED Lichtquelle
Note! Dimensions of the space
to install LED source

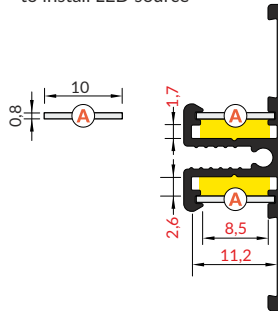

Länge 2.000 mm,
length 2000 mm

A transparent
Artikelnummer = 10 Stück
index = 10 pcs
9589070016

A satiniert / **A** frosted
Artikelnummer = 10 Stück
index = 10 pcs
9589070039

A opal
Artikelnummer = 10 Stück
index = 10 pcs
9589070038

Die Toleranz der Länge von Abdeckungen beträgt: +20 mm.
Mehr Informationen >> 1.08.

The standard cover length tolerance is +20 mm.
More details >> 1.08.

ENDKAPPEN / ENDINGS

Endkappe **BACK10**
Farben: weiß, silbern, schwarz, grau
Material: ABS
BACK10 ending
colours: white, silver, black, grey
material: ABS

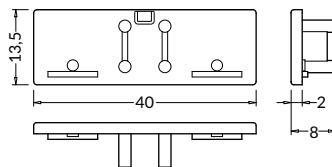

Artikelnummer = 10 Sets = 20 Stück
INDEX = 10 sets = 20 pcs

weiß / white
9590100001
silbern / silver
9590100040
schwarz / black
9590100002
grau / grey
9590100022

Endkappe **BACK10 mit Öffnung**
Farben: weiß, silbern, schwarz, grau
Material: ABS
BACK10 ending with hole
colours: white, silver, black, grey
material: ABS

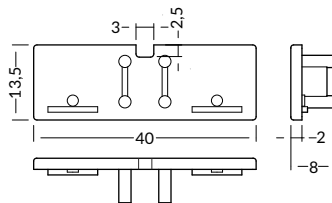

weiß / white
9590150001
silbern / silver
9590150040
schwarz / black
9590150002
grau / grey
9590150022

HALTER / MOUNTINGS

Halter **U** flexibel
Farben: inox
Material: rostfreier Stahl
U flexible mounting plate
colour: inox
material: stainless steel

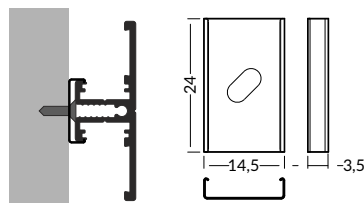

inox
9576380000

Halter **U** flexibel cone
Farben: inox
Material: rostfreier Stahl
cone **U** flexible mounting plate
colour: inox
material: stainless steel

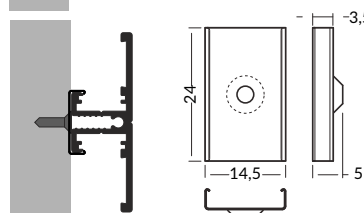

inox
9576620000

Halter **X**
Farben: Rohaluminium
Material: Aluminium
X mounting plate
colour: raw aluminium
material: aluminium

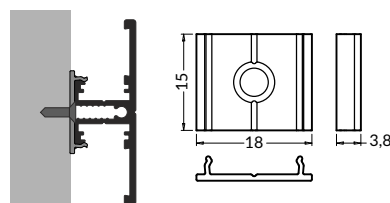

Rohaluminium
raw aluminium
9576260000



VERBINDUNGSTÜCKE / CONNECTORS

Verbindungsstück X 180 Grad

Farben: inox

Material: Aluminium

X connector 180 deg
colour: raw aluminium
material: aluminium

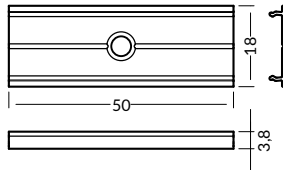

Artikelnummer = 1 Set,
INDEX = 1 set

Rohaluminium
raw aluminium
9576350000



STEP10 C

TREPPENPROFIL

STEP EDGE PROFILE

- akzentuierender oder beleuchtender Lichteffekt
- zwei Montagemöglichkeiten - drei Leuchtvarianten zur Wahl
- die Möglichkeit der Montage von einem Anti-Rutsch-Streifen
- eine versteckte Befestigung
- schlagbeständig
- maximale Breite des LED Streifens 10 mm

- highlighting or illuminating feature
- 2 mounting options - 3 lighting options to choose from
- anti slip insert installation option
- hidden mounting
- impact resistant
- maximum LED strip width: 10 mm



ÄHNLICHES IM ANGEBOT / SIMILAR IN THE OFFER



C Abdeckung **C** einclipsbar
C click cover

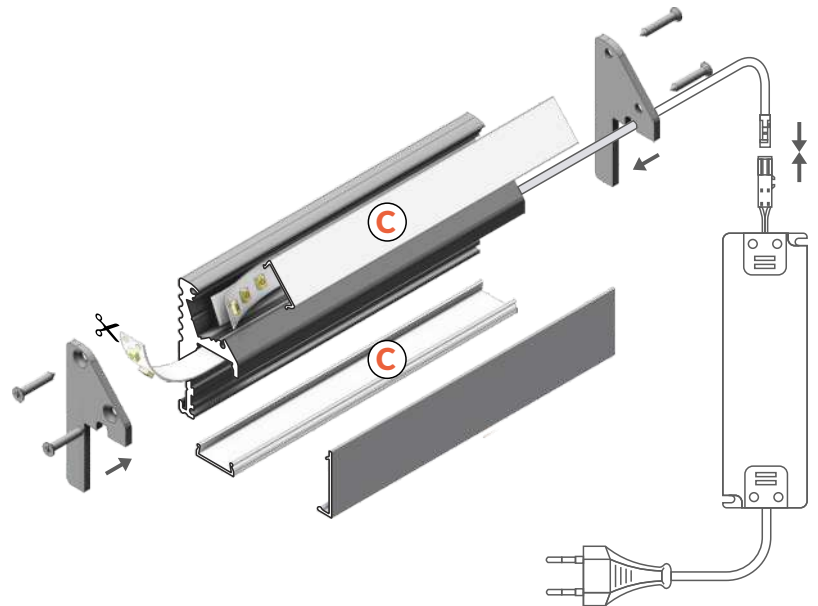
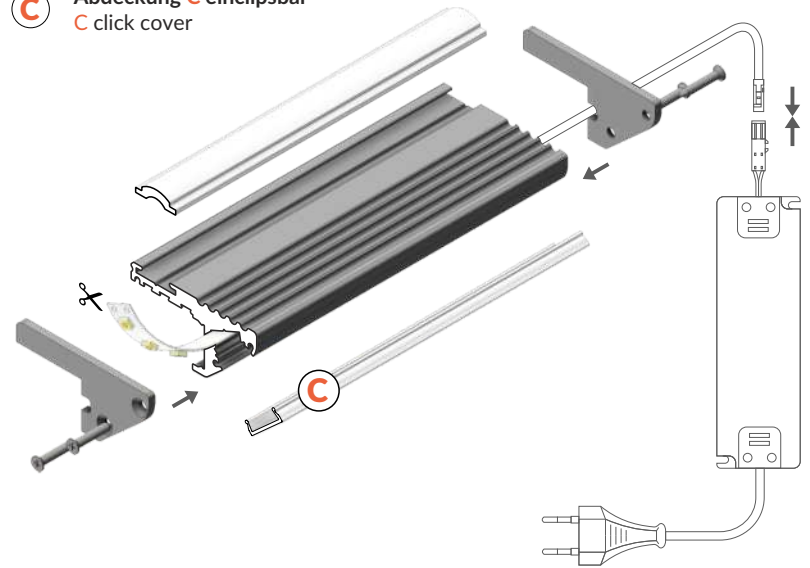
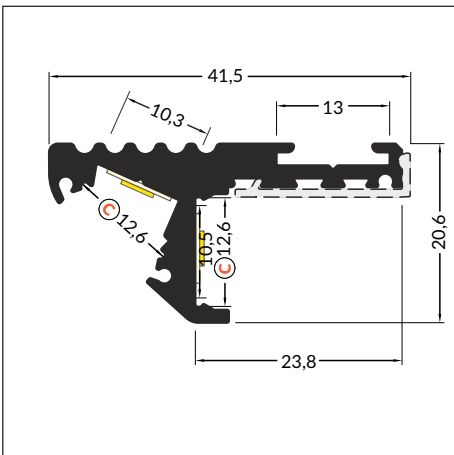
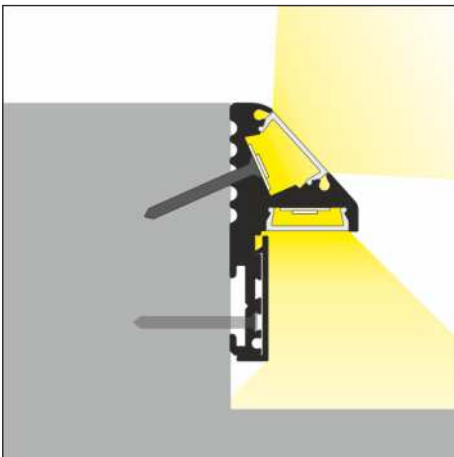
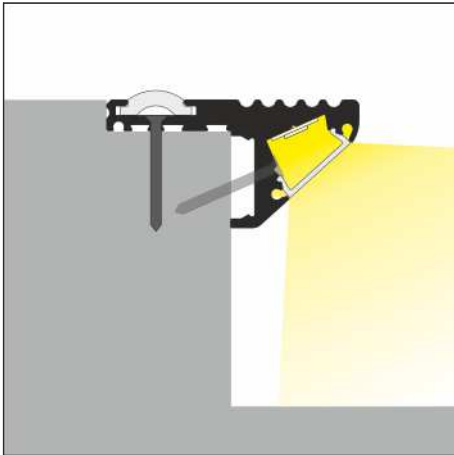

max 10 mm



spezielle Profile
special application



Artikelnummer = 1 Stück,
Länge 2.000 mm,
INDEX = 1 pc, length 2000 mm

eloxiert
anodized

9532080020

schwarz eloxiert
black anodized

9532080021

Die zugänglichen Längen: 1000 mm, 2000 mm, 3000 mm, 4000 mm.
Die standardmäßige Toleranz der Länge von Profilen beträgt: +20 mm.
Mehr Informationen >> 1.08.

Available lengths: 1000 mm, 2000 mm, 3000 mm, 4000 mm.
The standard profile length tolerance is +20 mm.
More details >> 1.08.



ABDECKUNG / COVERS

Abdeckung **C** einclipsbar
Farben: transparent, opal
Material: PMMA

C click cover
colours: transparent, opal
material: PMMA



Achtung! Die Abmessungen des Platzes für die Montage von LED Lichtquelle
Note! Dimensions of the space to install LED source

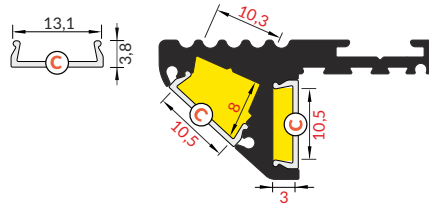

NEU



Länge 2.000 mm,
length 2000 mm

C transparent
Artikelnummer = 1 Stück
index = 1 pc
9576330000

C opal
Artikelnummer = 1 Stück
index = 1 pc
9576330038



Rolle, Länge 20 m,
reel, length 20 m

C opal
Artikelnummer = 1 Stück
index = 1 pc
9576360038S

Die Toleranz der Länge von Abdeckungen beträgt: +20 mm.
Mehr Informationen >> 1.08.
The standard cover length tolerance is +20 mm.
More details >> 1.08.

ENDKAPPEN / ENDINGS

Endkappe STEP10
Farben: silbern, schwarz
Material: Stahl
STEP10 ending
colours: silver, black
material: steel

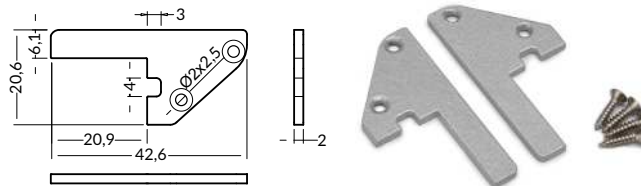

Artikelnummer = 1 Set = 2 Stück
INDEX = 1 set = 2 pcs

silbern
silver
9532100022

schwarz
black
9532100002

ALUMINIUMABDECKPLATTE / COVER

Aluminiumabdeckplatte für das LED Profil STEP10
Farben: eloxiert, schwarz
Material: Aluminium

STEP10 LED cover
colours: anodized, black
material: aluminium

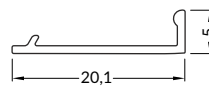

Artikelnummer = 1 Stück,
Länge 2.000 mm,
INDEX = 1 pc, length 2000 mm

eloxiert
anodized
9532120020

schwarz eloxiert
black anodized
9532120021

Die zugänglichen Längen: 1000 mm, 2000 mm, 3000 mm, 4000 mm.
Die standardmäßige Toleranz der Länge von Profilen beträgt: +20 mm.
Mehr Informationen auf der Seite 1.08.

Available lengths: 1000 mm, 2000 mm, 3000 mm, 4000 mm.
The standard profile length tolerance is +20 mm.
For more details please see page 1.08.

ANTI-RUTSCH-STREIFEN / INSERT

Anti-Rutsch-Streifen für STEP10
Farben: transparent, schwarz

STEP10 anti slip insert
colours: transparent, black



Artikelnummer = 1 Stück,
Länge 2.000 mm,
INDEX = 1 pc, length 2000 mm

transparent
transparent
9532150000

schwarz
black
9532150002

1. Das Beleuchten einer Treppe und die Anwendung eines Anti-Rutsch-Streifens.

1. Illuminating a step with anti slip insert applied.



2. Treppenbeleuchtung und Betonung von Treppenkanten.

2. Illuminating a step and edge highlighting.



WAY10 C

BELEUCHTUNGSLEISTE FÜR KOMMUNIKATIONSWEGE STRIP FOR ILLUMINATING PASSAGEWAYS

- zur Wandmontage bestimmt
 - verdeckte Halterung und Leitungen
 - ohne scharfe Kanten
 - maximale Breite des LED Streifens 10 mm
-
- dedicated for wall mounting
 - hidden mounting and wiring
 - curved shape
 - maximum LED strip width: 10 mm



ÄHNLICHES IM ANGEBOT / SIMILAR IN THE OFFER

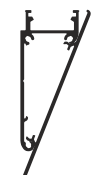

WALLE12
CD



BACK10
A/UX

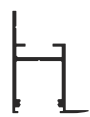

FRAME14
BC/Q



C Abdeckung **C** einclipsbar
C click cover

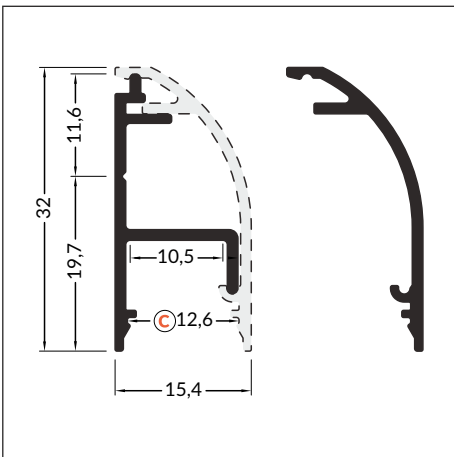
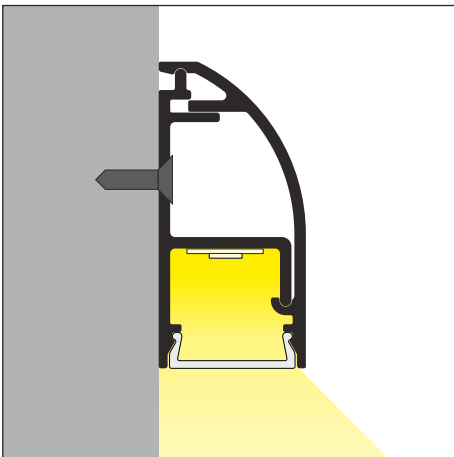
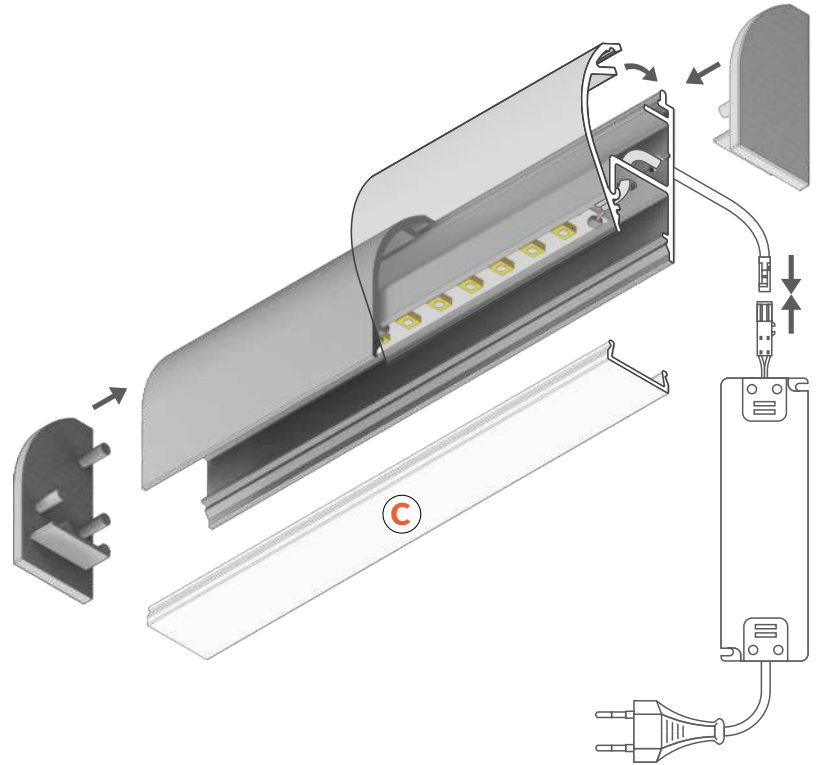

Artikelnummer = 1 Stück,
Länge 2.000 mm,
INDEX = 1 pc, length 2000 mm

eloxiert
anodized
95F9000220



Die zugänglichen Längen: 1000 mm, 2000 mm, 3000 mm, 4000 mm.
Die standardmäßige Toleranz der Länge von Profilen beträgt: +20 mm.
Mehr Informationen >> 1.08.

Available lengths: 1000 mm, 2000 mm, 3000 mm, 4000 mm.
The standard profile length tolerance is +20 mm.
More details >> 1.08.



max 10 mm



spezielle Profile
special application



ABDECKUNG / COVERS

Abdeckung **C** einclipsbar
Farben: transparent, opal
Material: PMMA

C click cover
colours: transparent, opal
material: PMMA



Achtung! Die Abmessungen des Platzes für die Montage von LED Lichtquelle
Note! Dimensions of the space to install LED source

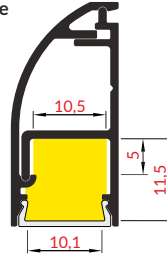
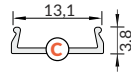

Länge 2.000 mm,
length 2000 mm

C transparent
Artikelnummer = 1 Stück
index = 1 pc
9576330000

C opal
Artikelnummer = 1 Stück
index = 1 pc
9576330038



Rolle, Länge 20 m,
reel, length 20 m

C opal
Artikelnummer = 1 Stück
index = 1 pc
9576360038S

NEU

Die Toleranz der Länge von Abdeckungen beträgt: +20 mm.
Mehr Informationen >> 1.08.
The standard cover length tolerance is +20 mm.
More details >> 1.08.

ENDKAPPEN / ENDINGS

Endkappe WAY10
Farben: weiß, silbern, schwarz, grau
Material: ABS

WAY10 ending
colours: white, silver, black, grey
material: ABS

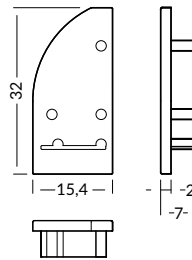

Die Endkappe mit Punkten für das Bohren von Öffnungen.
Ending with marked space to bore the holes.

Artikelnummer = 10 Sets = 20 Stück
INDEX = 10 sets = 20 pcs

weiß / white
95F9009901

silbern / silver
95F9009940

schwarz / black
95F9009902

grau / grey
95F9009922

ALUMINIUMABDECKPLATTE / COVER

Aluminiumabdeckplatte für das LED Profil WAY10
Farben: weiß, eloxiert, schwarz, Rohaluminium
Material: Aluminium

WAY10 LED cover
colours: white, anodized, black, raw aluminium
material: aluminium

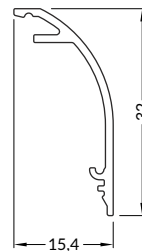

Artikelnummer = 1 Stück,
Länge 2.000 mm,
INDEX = 1 pc, length 2000 mm

weiß lackiert
white painted
95F9000601

eloxiert
anodized
95F9000620

schwarz lackiert
black painted
95F9000602

Rohaluminium
raw aluminium
95F9000600

Die zugänglichen Längen: 1000 mm, 2000 mm, 3000 mm, 4000 mm. Die standardmäßige Toleranz der Länge von Profilen beträgt: +20 mm.
Mehr Informationen >> 1.08.
Available lengths: 1000 mm, 2000 mm, 3000 mm, 4000 mm.
The standard profile length tolerance is +20 mm.
More details >> 1.08.



ARC12 CD/U5

EIN BIEGBARES ALUMINIUMPROFIL

FLEXIBLE ALUMINIUM LED PROFILE

- ein in zwei Richtungen einer Ebene biegbares Aluminiumprofil
- das Profil behält die Biegungsform bei
- minimaler Biegungsradius: 50 cm
- die Möglichkeit zwei Abdeckungen anzuwenden - bessere Lichtstreuung
- Montage im Außenbereich möglich (bei dem Anwenden einer D klick Abdeckung und eines wasserdichten LED Streifens)
- maximale Breite des LED Streifens 12 mm

- flexible aluminium profile - possibility of bending in two directions
- the profile keeps shaped bend
- minimal bending radius: 50 cm
- possibility of using two diffusers - better light dispersion
- possible outside installation (with D cover and waterproof LED strip used)
- maximum LED strip width: 12 mm



ÄHNLICHES IM ANGEBOT / SIMILAR IN THE OFFER

SLIM8
AC2/Z

SMART10
AC2/Z

BEGTON12
J/S

UNI12
BCD/U



C Abdeckung C einclipsbar
C click cover

D Abdeckung D einclipsbar
D click cover

U5¹ Halter U5
U5 mounting plate

U5² Seitenhalter U5
side U5 mounting plate

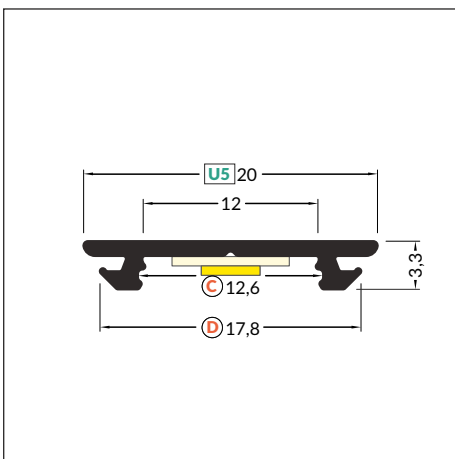
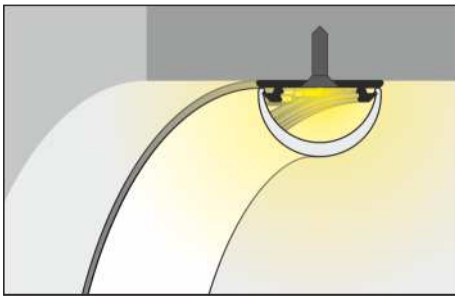
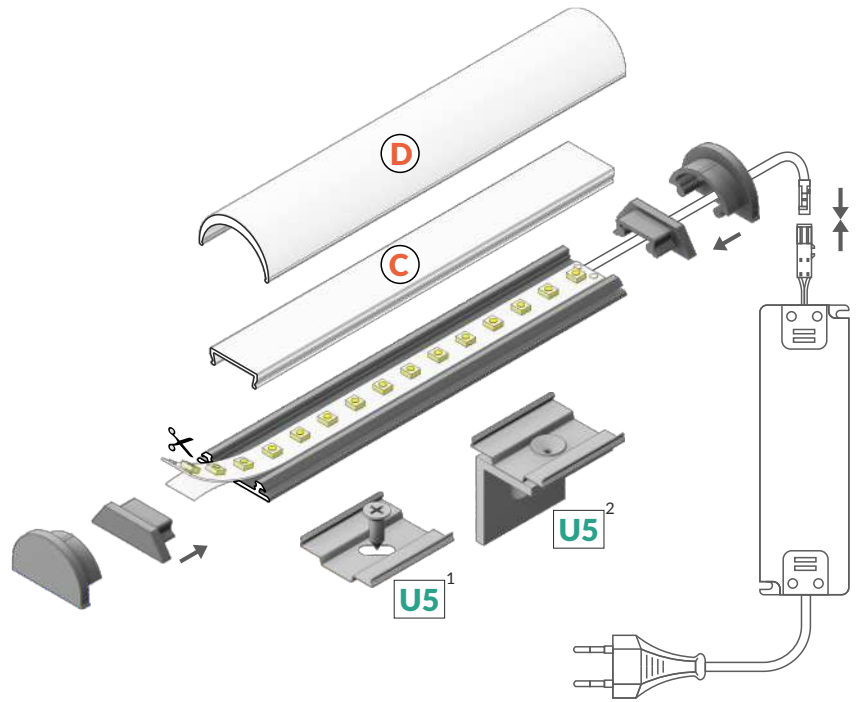

 max 12 mm

 spezielle Profile
special application



Artikelnummer = 1 Stück,
Länge 2.000 mm,
INDEX = 1 pc, length 2000 mm

weiß lackiert
white painted
95B2010001



eloxiert
anodized
95B2010020



schwarz lackiert
black painted
95B2010002



Rohaluminium
raw aluminium
95B2010000

Die zugänglichen Längen: 1000 mm, 2000 mm, 3000 mm, 4000 mm.
Die standardmäßige Toleranz der Länge von Profilen beträgt: +20 mm.
Mehr Informationen >> 1.08.

Available lengths: 1000 mm, 2000 mm, 3000 mm, 4000 mm.
The standard profile length tolerance is +20 mm.
More details >> 1.08.



ABDECKUNG / COVERS

Abdeckung **C** einclipsbar
Farben: transparent, opal
Material: PMMA

C click cover
colours: transparent, opal
material: PMMA



Achtung! Die Abmessungen des Platzes für die Montage von LED Lichtquelle
Note! Dimensions of the space to install LED source

Eine maximale Breite des LED Streifens
Bei der Anwendung von der Abdeckung C 10 mm
Maximum LED strip width
while using C cover: 10 mm

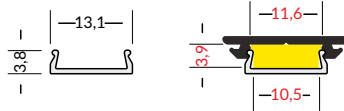

NEU



Länge 2.000 mm,
length 2000 mm

C transparent
Artikelnummer = 1 Stück
index = 1 pc
9576330000

C opal
Artikelnummer = 1 Stück
index = 1 pc
9576330038



Rolle, Länge 20 m,
reel, length 20 m

C opal
Artikelnummer = 1 Stück
index = 1 pc
9576360038S



Länge 2.000 mm,
length 2000 mm

D opal
Artikelnummer = 1 Stück
index = 1 pc
95A1140038

Die Toleranz der Länge von Abdeckungen beträgt: +20 mm.
Mehr Informationen >> 1.08.

The standard cover length tolerance is +20 mm.
More details >> 1.08.

Abdeckung **D** einclipsbar
Farben: opal
Material: PMMA

D click cover
colour: opal
material: PMMA

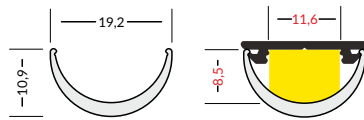

ENDKAPPEN / ENDINGS

Endkappe **ARC12**
Farben: weiß, silbern, schwarz, grau
Material: ABS
ARC12 ending
colours: white, silver, black, grey
material: ABS



Die Endkappe mit Punkten für das Bohren von Öffnungen.
Ending with marked space to bore the holes.

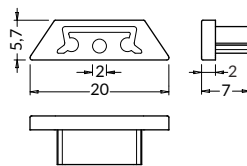

Endkappe **ARC12 D**
Farben: weiß, silbern, schwarz, grau
Material: ABS
ARC12 D ending
colours: white, silver, black, grey
material: ABS

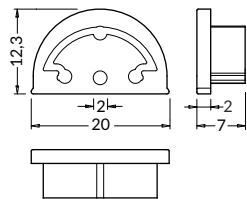

Artikelnummer = 10 Sets = 20 Stück
INDEX = 10 sets = 20 pcs

weiß / white
95B2960001

silbern / silver
95B2960040

schwarz / black
95B2960002

grau / grey
95B2960022

weiß / white
95B2980001

silbern / silver
95B2980040

schwarz / black
95B2980002

grau / grey
95B2980022

HALTER / MOUNTINGS

Halter **U5** cone
Farben: inox
Material: rostfreier Stahl
cone **U5** mounting plate
colour: inox
material: stainless steel

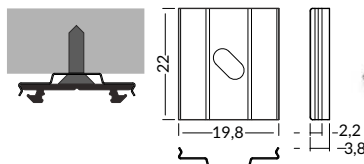

Artikelnummer = 10 Sets = 20 Stück
INDEX = 10 sets = 20 pcs

inox
95B2940019

Seitenhalter **U5**
Farben: weiß, silbern, schwarz
Material: rostfreier Stahl, Aluminium
side **U5** mounting plate
colours: white, silver, black
material: stainless steel, aluminium

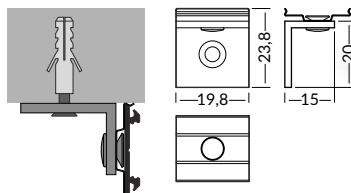

weiß / white
95B2920001

silbern / silver
95B2920022

schwarz / black
95B2920002



ABHÄNGUNG / SLING

Abhängung SELV 50V 1500
Farben: weiß, silbern, schwarz
SELV sling 50 V 1500
colour: white, silver, black

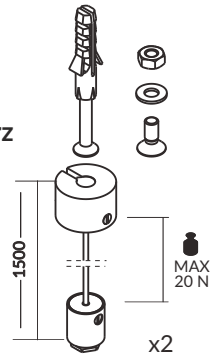

Artikelnummer = 1 Set = 2 Stück
INDEX = 1 set = 2 pcs

weiß / white
9567120001

silbern / silver
9567120022

schwarz / black
9567120002



FIX12 / FIX16



DIE EINFACHSTE MONTAGE DES LED STREIFENS

THE SIMPLEST INSTALLATION OF A LED STRIP

- Wärmeabfuhrfunktion
- festeres Haften der LED Lichtquelle
- Profil mit gerinster Aufbauhöhe
- ein Budget-Profil für die Anwendung ohne Abdeckung
- maximale Breite des LED Streifens: 12 mm (FIX12) und 16 mm (FIX16)
- es kann auch die Montagefunktion erfüllen:
FIX12 für die Profile mit Befestigungssockel X
FIX16 für die Profile mit Befestigungssockel T

- function of radiator
- improves LED strip's adhesion
- minimal height of the profile
- budget profile, to be used without a cover
- maximum width of LED strip: 12 mm (FIX12) and 16 mm (FIX16)
- it can also function as a mounting profile:
FIX12 for profiles with X socket
FIX16 for profiles with T socket



ÄHNLICHES IM ANGEBOT / SIMILAR IN THE OFFER

SLIM8
AC2/Z



SMART10
AC2/Z

SURFACE10
BC/UX

BEGTON12
J/S

ARC12
CD/R

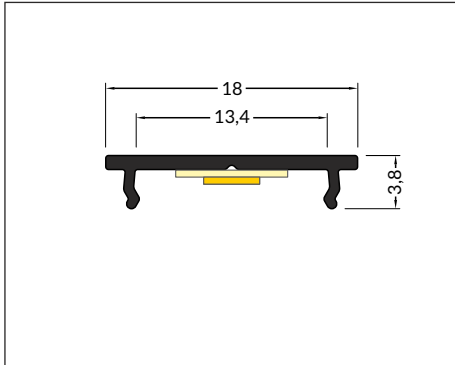
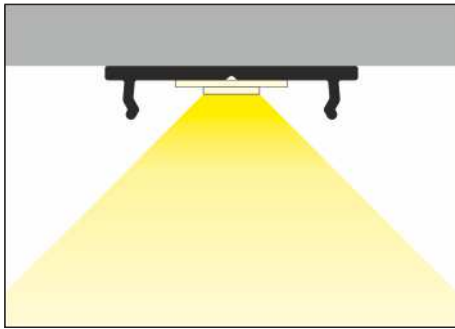
SURFACE14
EF/TY



max 12 mm



spezielle Profile
special application



Die Montage mit Hilfe
von Schrauben oder einem
doppelseitigem Klebeband
mounting with screws
or adhesive tape



Artikelnummer = 1 Stück,
Länge 2.000 mm,
INDEX = 1 pc, length 2000 mm

eloxiert
anodized
9587030020



Rohaluminium
raw aluminium
9587030000

Die zugänglichen Längen: 1000 mm, 2000 mm, 3000 mm, 4000 mm.
Die standardmäßige Toleranz der Länge von Profilen beträgt: +20 mm.
Mehr Informationen >> 1.08.

Available lengths: 1000 mm, 2000 mm, 3000 mm, 4000 mm.
The standard profile length tolerance is +20 mm.
More details >> 1.08.

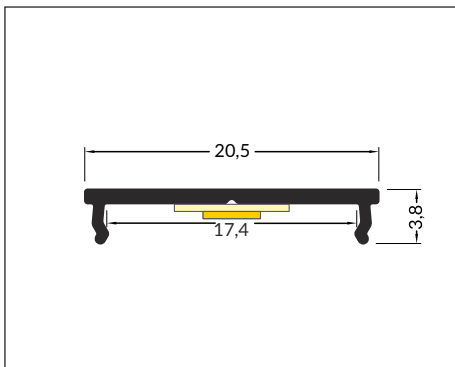
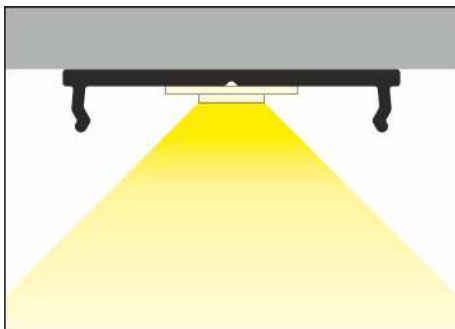

max 16 mm



spezielle Profile
special application



Die Montage mit Hilfe
von Schrauben oder einem
doppelseitigem Klebeband
mounting with screws
or adhesive tape



Artikelnummer = 1 Stück,
Länge 2.000 mm,
INDEX = 1 pc, length 2000 mm

weiß lackiert
white painted
95C6020001



eloxiert
anodized
95C6020020



schwarz eloxiert
black anodized
95C6020021



Rohaluminium
raw aluminium
95C6020000

Die zugänglichen Längen: 1000 mm, 2000 mm, 3000 mm, 4000 mm.
Die standardmäßige Toleranz der Länge von Profilen beträgt: +20 mm.
Mehr Informationen >> 1.08.

Available lengths: 1000 mm, 2000 mm, 3000 mm, 4000 mm.
The standard profile length tolerance is +20 mm.
More details >> 1.08.

WALLE12 BCD

EIN WANDPROFIL

WALL-MOUNTED PROFILE

- zur Montage direkt an der Wand oder Decke
 - 6 Abdeckungen zur Wahl
 - Montage im Außenbereich möglich
(bei dem Anwenden einer D klick Abdeckung und eines wasserdichten LED Streifens)
 - maximale Breite des LED Streifens 12 mm
-
- mounted directly to a wall or ceiling
 - 6 types of matching covers
 - possibility of outdoor using (with D cover and waterproof LED strip)
 - maximum LED strip width: 12 mm

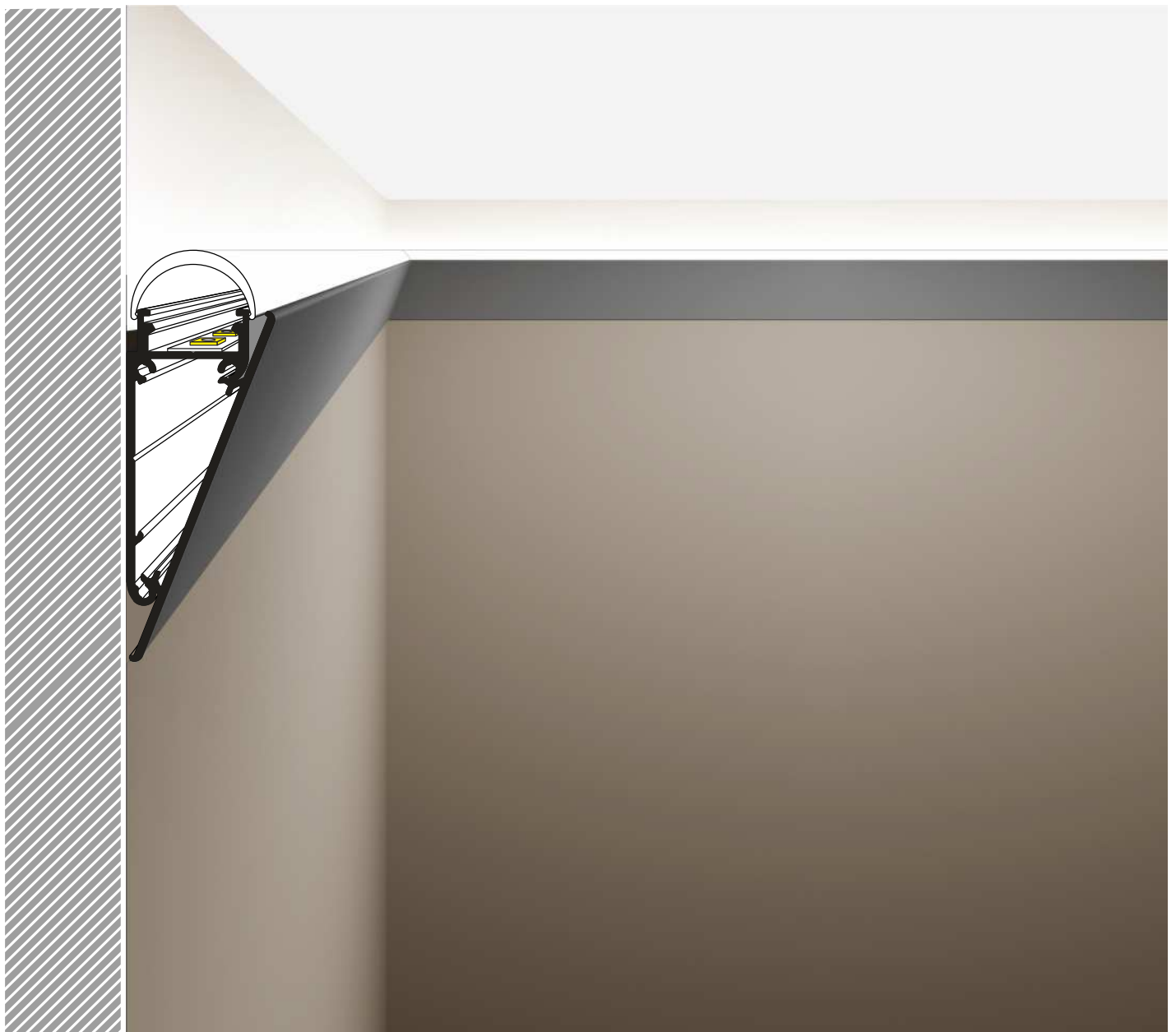

ÄHNLICHES IM ANGEBOT / SIMILAR IN THE OFFER



WAY10
C



FLAT8
H/UX



BACK10
A/UX



FRAME14
BC/Q



- B** Abdeckung **B** einschiebbar
B slide cover
- C** Abdeckung **C** einclipsbar
C click cover
- D** Abdeckung **D** einclipsbar
D click cover

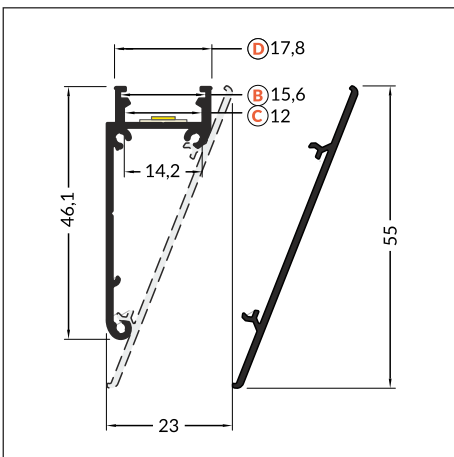
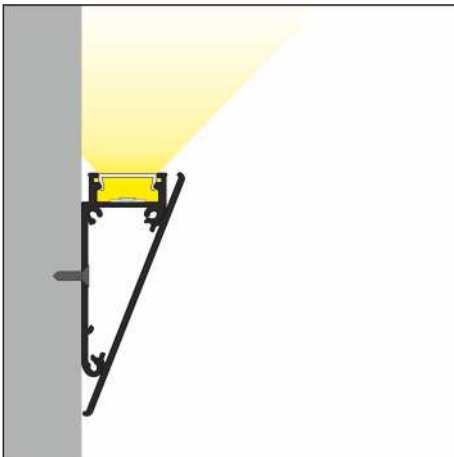
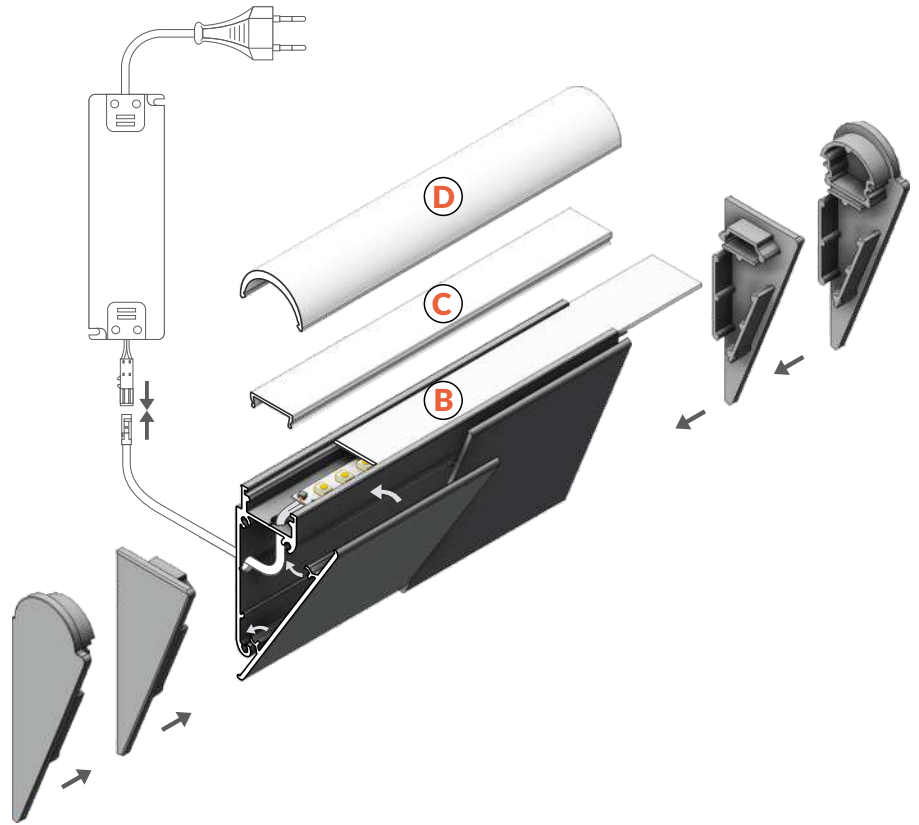

 max 12 mm

 spezielle Profile
special application

Artikelnummer = 1 Stück,
Länge 2.000 mm,
INDEX = 1 pc, length 2000 mm

weiß lackiert
white painted
95B8060001

eloxiert
anodized
95B8020020

Rohaluminium
raw aluminium
95B8020000



Die zugänglichen Längen: 1000 mm, 2000 mm, 3000 mm, 4000 mm.
Die standardmäßige Toleranz der Länge von Profilen beträgt: +20 mm.
Mehr Informationen >> 1.08.

Available lengths: 1000 mm, 2000 mm, 3000 mm, 4000 mm.
The standard profile length tolerance is +20 mm.
More details >> 1.08.



ABDECKUNG / COVERS

Abdeckung B einschiebbar
Farben: transparent, satiniert, opal
Material: PC, PP, PP

B slide cover
colours: transparent, frosted, opal
material: PC, PP, PP

Abdeckung C einclipsbar
Farben: transparent, opal
Material: PMMA

C click cover
colours: transparent, opal
material: PMMA

Abdeckung D einclipsbar
Farben: opal
Material: PMMA

D click cover
colour: opal
material: PMMA



Achtung! Die Abmessungen des Platzes für die Montage von LED Lichtquelle
Note! Dimensions of the space to install LED source

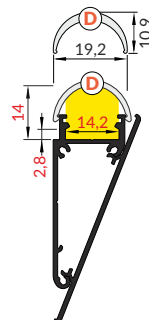
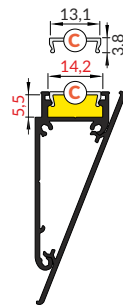
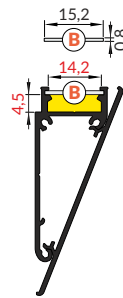

NEU



Länge 2.000 mm,
length 2000 mm

B transparent
Artikelnummer = 10 Stück
index = 10 pcs
9576250016

B satiniert / B frosted
Artikelnummer = 10 Stück
index = 10 pcs
9576250039

B opal
Artikelnummer = 10 Stück
index = 10 pcs
9576250038

C transparent
Artikelnummer = 1 Stück
index = 1 pc
9576330000

C opal
Artikelnummer = 1 Stück
index = 1 pc
9576330038

Rolle, Länge 20 m,
reel, length 20 m

C opal
Artikelnummer = 1 Stück
index = 1 pc
9576360038s

Länge 2.000 mm,
length 2000 mm

D opal
Artikelnummer = 1 Stück
index = 1 pc
95A1140038

Die Toleranz der Länge von Abdeckungen beträgt: +20 mm.
Mehr Informationen >> 1.08.
The standard cover length tolerance is +20 mm.
More details >> 1.08.

ENDKAPPEN / ENDINGS

Endkappe WALLE12
Farben: weiß, silbern, grau
Material: ABS

WALLE12 ending
colours: white, silver, grey
material: ABS

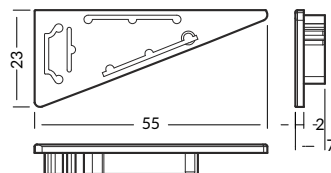

Endkappe WALLE12 D
Farben: weiß, silbern, grau
Material: ABS

WALLE12 D ending
colours: white, silver, grey
material: ABS

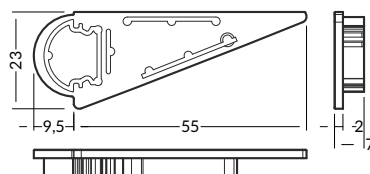

Artikelnummer = 10 Sets = 20 Stück
INDEX = 10 sets = 20 pcs

weiß / white
95B8900001

silbern / silver
95B8900040

grau / grey
95B8900022

weiß / white
95B8890001

silbern / silver
95B8890040

grau / grey
95B8890022



ALUMINIUMABDECKPLATTE / COVER

Aluminiumabdeckplatte für das LED Profil WALLE12

Farben: weiß, eloxiert

Material: Aluminium

WALLE12 cover

colours: white, anodized

material: aluminium



Artikelnummer = 1 Stück,
Länge 2.000 mm,
INDEX = 1 pc, length 2000 mm

weiß lackiert / white painted

95B808001

eloxiert / anodized

95B8040020

Die zugänglichen Längen: 1000 mm, 2000 mm, 3000 mm, 4000 mm.
Die standardmäßige Toleranz der Länge von Profilen beträgt: +20 mm.
Mehr Informationen >> 1.08.

Available lengths: 1000 mm, 2000 mm, 3000 mm, 4000 mm.
The standard profile length tolerance is +20 mm. More details >> 1.08.

VERBINDUNGSSTÜCKE / CONNECTORS

Verbinder 180 Grad für WALLE12

Farben: inox

material: rostfreier Stahl

WALLE12 connector 180 deg

colour: inox

material: stainless steel

Verbinder 90 Grad für WALLE12

Farben: weiß, eloxiert

Material: Aluminium

WALLE12 connector 90 deg

colours: white, anodized

material: aluminium

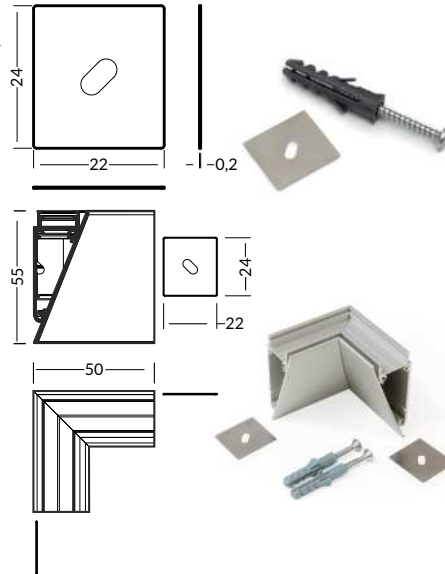

Artikelnummer = 1 Set,
INDEX = 1 set

inox

95B8950019

weiß lackiert
white painted

95B8910001

eloxiert
anodized

95B8910020



PEN12 CJ

DREHSYSTEM FÜR EXPOSITIONSBELEUCHTUNG

ROTATABLE DISPLAY LIGHTING SYSTEM

- für Wände und Möbel
- unterschiedliche Halterungen
- maximum LED strip width: 12 mm

- wall and furniture application
- various types of mounting brackets
- maximum LED strip width: 12 mm



ÄHNLICHES IM ANGEBOT / SIMILAR IN THE OFFER



PEN8
I



CABI12
E



CORNER10
BC/UX



TRIO10
BC



OVAL20
BC



- J** Abdeckung **J** einschiebbar
J slide cover
- C** Abdeckung **C** einclipsbar
C click cover
- C** Abdeckung **C** einclipsbar Linse
C lens cover

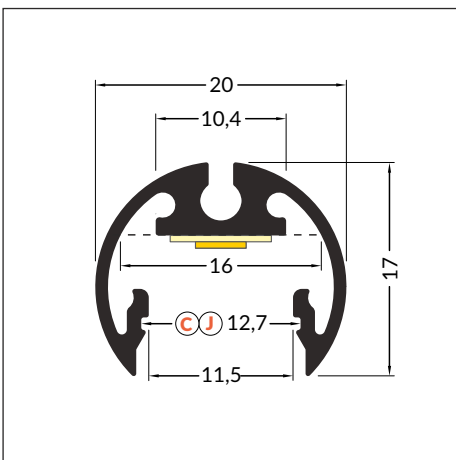
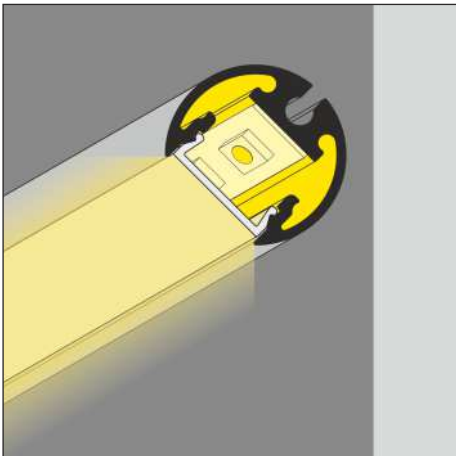
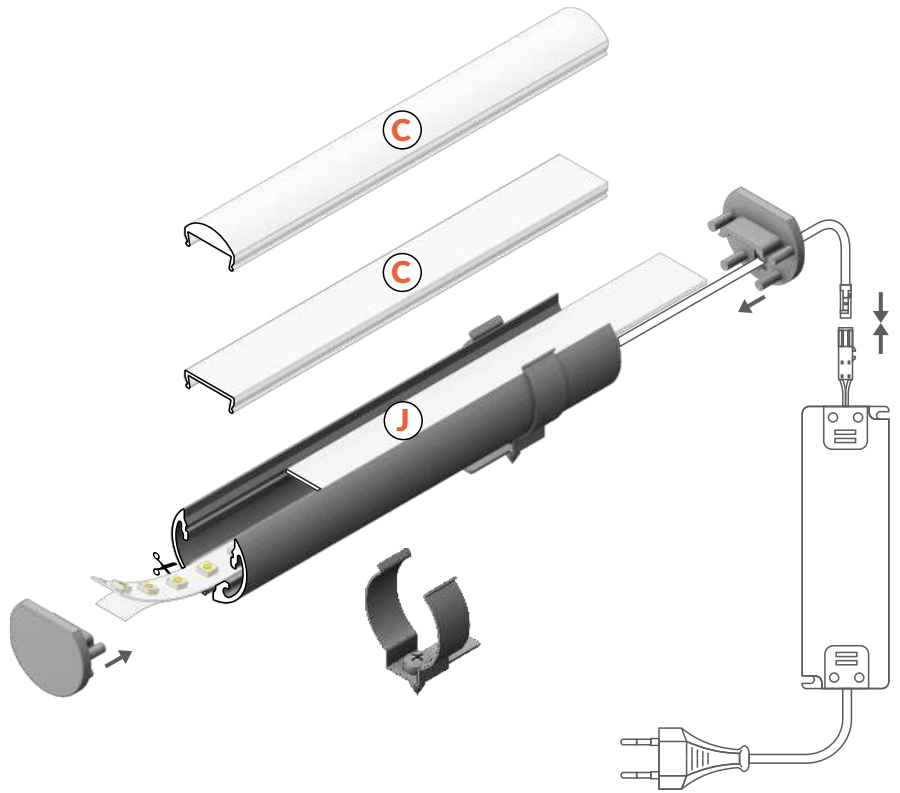

max 12 mm



spezielle Profile
special application



Artikelnummer = 1 Stück,
Länge 2.000 mm,
INDEX = 1 pc, length 2000 mm

weiß lackiert
white painted
95F7000201



eloxiert
anodized
95F7000220



schwarz lackiert
black painted
95F7000202

Die zugänglichen Längen: 1000 mm, 2000 mm, 3000 mm, 4000 mm.
Die standardmäßige Toleranz der Länge von Profilen beträgt: +20 mm.
Mehr Informationen >> 1.08.

Available lengths: 1000 mm, 2000 mm, 3000 mm, 4000 mm.
The standard profile length tolerance is +20 mm.
More details >> 1.08.



ABDECKUNG / COVERS

Abdeckung J einschiebbar
Farben: transparent, satiniert, opal
Material: PC, PP, PP

J slide cover
colours: transparent, frosted, opal
material: PC, PP, PP



Achtung! Die Abmessungen des Platzes für die Montage von LED Lichtquelle
Note! Dimensions of the space to install LED source

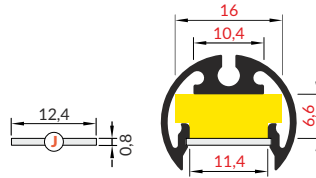

Länge 2,000 mm,
length 2000 mm

J transparent
Artikelnummer = 10 Stück
index = 10 pcs
9570330016



J satiniert / J frosted
Artikelnummer = 10 Stück
index = 10 pcs
9570330039

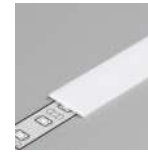

J opal
Artikelnummer = 10 Stück
index = 10 pcs
9570330038



C transparent
Artikelnummer = 10 Stück
index = 1 pc
9576330000



C opal
Artikelnummer = 1 Stück
index = 1 pc
9576330038

Abdeckung C einclipsbar
Farben: transparent, opal
Material: PMMA

C click cover
colours: transparent, opal
material: PMMA

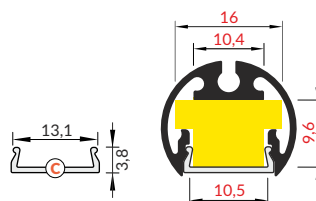

Rolle, Länge 20 m,
reel, length 20 m

C opal
Artikelnummer = 1 Stück
index = 1 pc
9576360038S

Abdeckung C einclipsbar Linse
Farben: transparent
Material: PC

C click cover lens
colour: transparent
material: PC

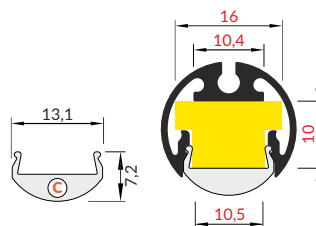

Länge 2,000 mm,
length 2000 mm

C Linse / C lens
Artikelnummer = 1 Stück
index = 1 pc
9576330000

Die Toleranz der Länge von Abdeckungen beträgt: +20 mm.
Mehr Informationen >> 1.08.
The standard cover length tolerance is +20 mm.
More details >> 1.08.

NEU

ENDKAPPEN / ENDINGS

Endkappe PEN12
Farben: weiß, silbern, schwarz, grau
Material: ABS

PEN12 ending
colours: white, silver, black, grey
material: ABS



Die Endkappe mit Punkten für das Bohren von Öffnungen.
Ending with marked space to bore the holes.

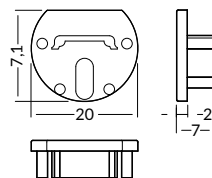

Artikelnummer = 10 Sets = 20 Stück
INDEX = 10 sets = 20 pcs

weiß / white
95F7009901

silbern / silver
95F7009940

schwarz / black
95F7009902

grau / grey
95F7009922

HALTER / MOUNTINGS

Halter PEN12 flach
Farben: inox
Material: rostfreier Stahl

PEN12 flat holder
colour: inox
material: stainless steel

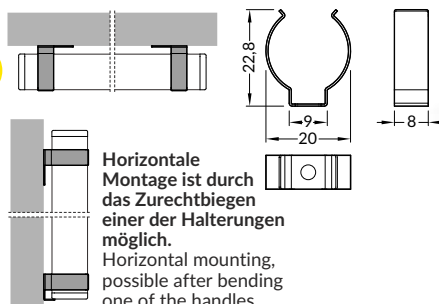

Horizontale Montage ist durch das Zurechtbiegen einer der Halterungen möglich.
Horizontal mounting, possible after bending one of the handles.



Artikelnummer = 10 Sets = 20 Stück
INDEX = 10 sets = 20 pcs

inox
95F7009019



HALTER / MOUNTINGS

Dübelhalter PEN12

Farben: Chrom
Material: Messing

PEN12 stretcher holder
colour: chrome
material: brass

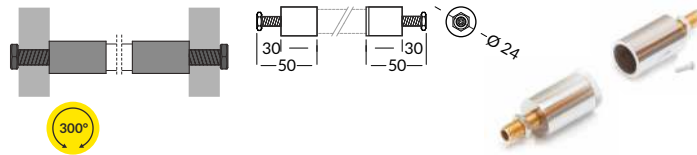

Artikelnummer = 1 Set = 2 Stück
INDEX = 1 set = 2 pcs

Chrom / chrome
95F7009103

Montagering PEN12

Farben: Chrom
Material: Messing

PEN12 ring holder
colours: chrome
material: brass

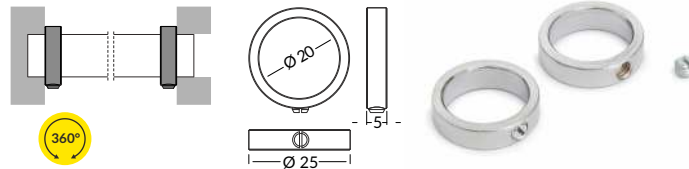

Chrom / chrome
95F7009203

Doppelhalter mit Gewinde für PEN12

Farben: Chrom
Material: Stahl, Messing

PEN12 double holder with thread
colour: chrome
material: steel, brass

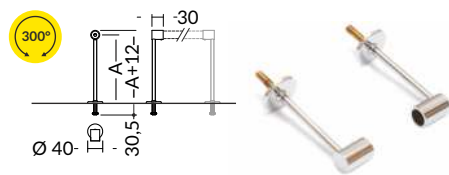

A =
100 mm **95F7009303**
200 mm **95F7009403**
300 mm **95F7009503**

Doppelhalter mit Deckenhalter für PEN12

Farben: Chrom
Material: Stahl, Messing

PEN12 double holder with soffit ceiling
colour: chrome
material: steel, brass

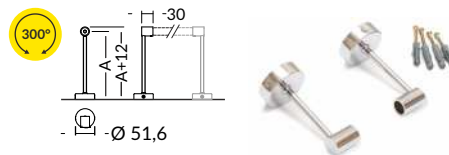

A =
100 mm **95F7009603**
200 mm **95F7009703**
300 mm **95F7009803**

Halter PEN12 Wandausleger

Farben: weiß, silbern, schwarz
Material: Stahl, Messing

PEN12 wall-mounted extension arm
colours: white, silver, black
material: steel, brass

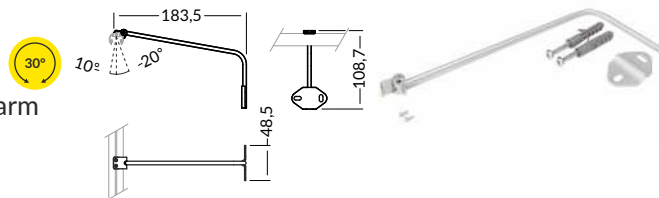

Artikelnummer = 1 Set = 1 Stück
INDEX = 1 set = 1 pc

weiß white **95F7008801**
silbern silver **95F7008822**
schwarz black **95F7008802**

Halter PEN12 Schrankausleger

Farben: weiß, silbern, schwarz
Material: Stahl, Messing

PEN12 cabinet-mounted extension arm
colours: white, silver, black
material: steel, brass

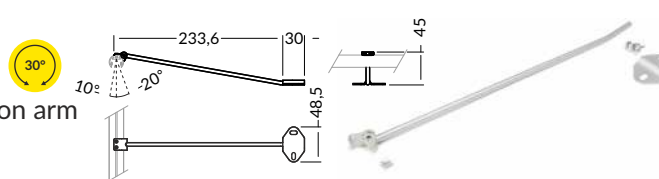

weiß white **95F7008901**
silbern silver **95F7008922**
schwarz black **95F7008902**



FAMILIE DER PROFILE ZUR UNTERFLIESEN-MONTAGE

FAMILY OF PROFILES FOR UNDER-TILE MOUNTING

- drei Montagewinkel lieferbar: 90 / 180 / 270 Grad
- für Fliesen bis 10 mm Dicke
- in Ausführung mit vorgefertigten Montagelöchern lieferbar
- maximale Breite des LED Streifens 12 mm

- three mounting angles available: 90, 180, 270 degrees
- for 10 mm tiles
- version with perforated mounting holes available
- maximum LED strip width: 12 mm



ÄHNLICHES IM ANGEBOT / SIMILAR IN THE OFFER



UNI-TILE12 90 Grad/deg C



C Abdeckung **C** einclipsbar
C click cover

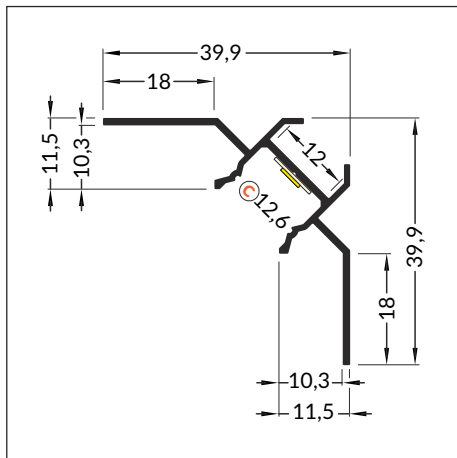
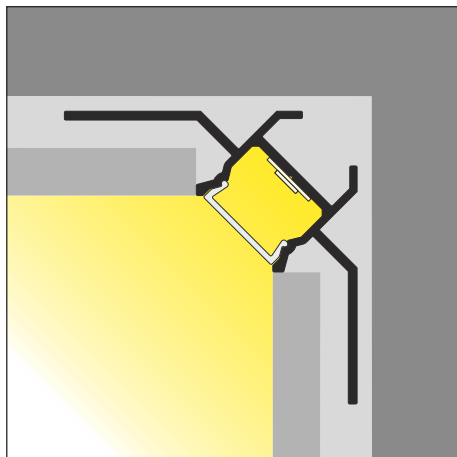
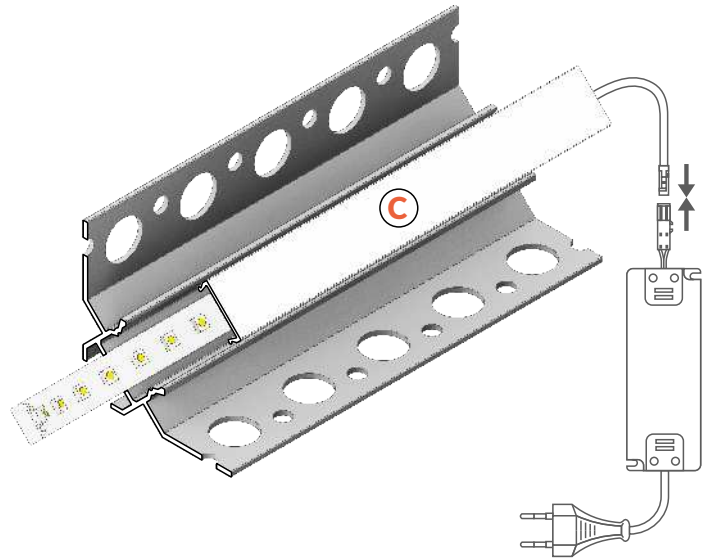

Artikelnummer = 1 Stück, Länge 2.000 mm
 INDEX = 1 pc, length 2000 mm

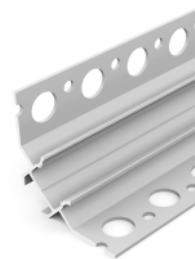

90 Grad PLUS
 eloxiert
 anodized
95G4000620



90 Grad
 eloxiert
 anodized
95G4000220



max 12 mm



spezielle Profile
 special application

Zugängliche Längen der Version PLUS: 1000 mm, 2000 mm, 2500 mm, 3000 mm, 4000 mm.
 Zugängliche Längen der Standardversion: 1000 mm, 2000 mm, 3000 mm, 4000 mm.
 Die standardmäßige Toleranz der Länge von Profilen beträgt: +20 mm.
 Mehr Informationen >> 1.08.

PLUS version available lengths: 1000 mm, 2000 mm, 2500 mm, 3000 mm, 4000 mm.
 Standard version available lengths: 1000 mm, 2000 mm, 3000 mm, 4000 mm.
 The standard profile length tolerance is +20 mm. More details >> 1.08.

UNI-TILE12 180 Grad/deg C



C Abdeckung C einclipsbar
C click cover

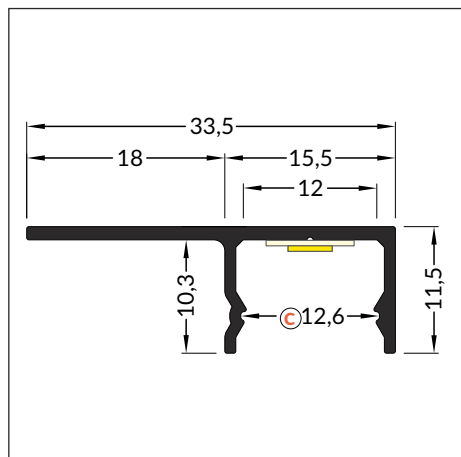
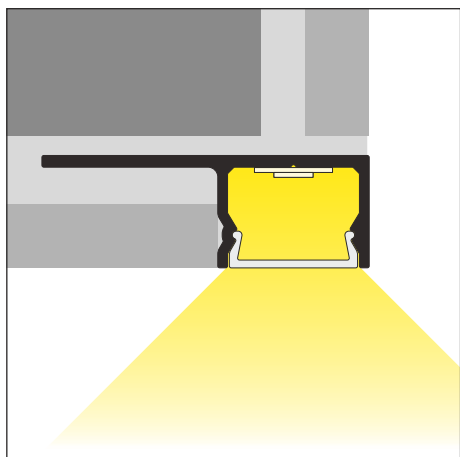
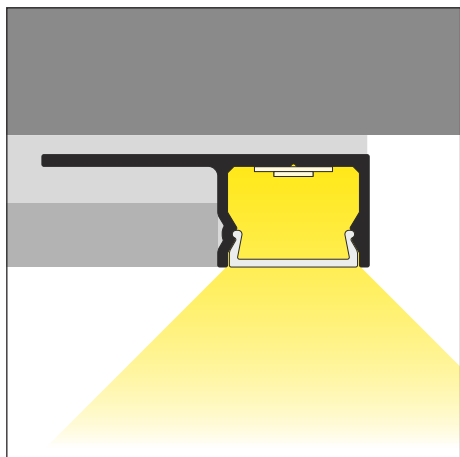

 max 12 mm

 spezielle Profile
special application

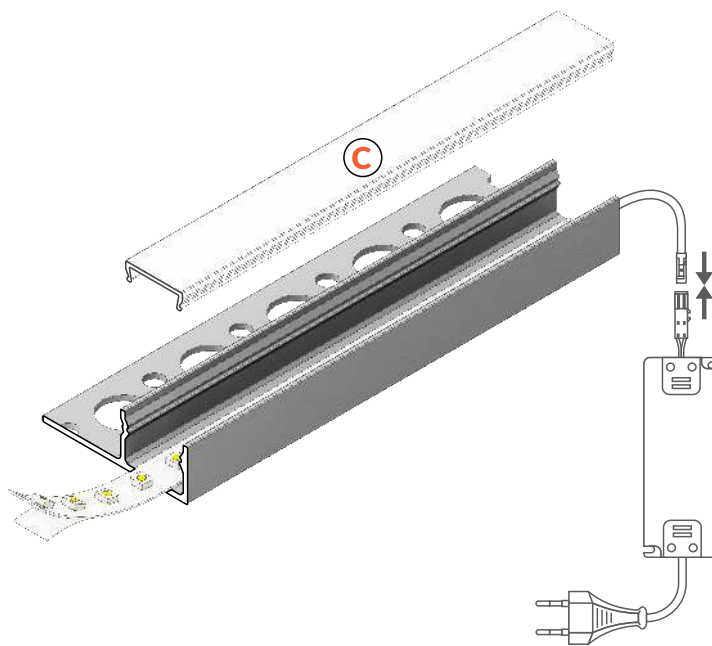

Artikelnummer = 1 Stück, Länge 2.000 mm
INDEX = 1 pc, length 2000 mm

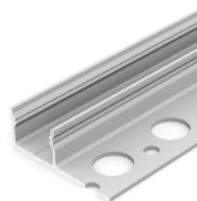

180 Grad PLUS
eloxiert
anodized
95G2000620

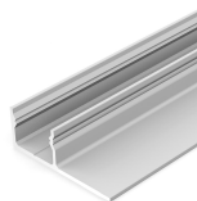

180 Grad
eloxiert
anodized
95G2000220

Zugängliche Längen der Version PLUS: 1000 mm, 2000 mm, 2500 mm, 3000 mm, 4000 mm.
Zugängliche Längen der Standardversion: 1000 mm, 2000 mm, 3000 mm, 4000 mm.
Die standardmäßige Toleranz der Länge von Profilen beträgt: +20 mm.
Mehr Informationen >> 1.08.

PLUS version available lengths: 1000 mm, 2000 mm, 2500 mm, 3000 mm, 4000 mm.
Standard version available lengths: 1000 mm, 2000 mm, 3000 mm, 4000 mm.
The standard profile length tolerance is +20 mm. More details >> 1.08.

UNI-TILE12 270 Grad/deg C

C Abdeckung **C** einclipsbar
C click cover

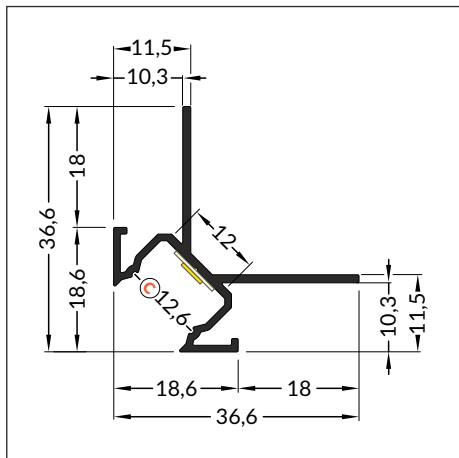
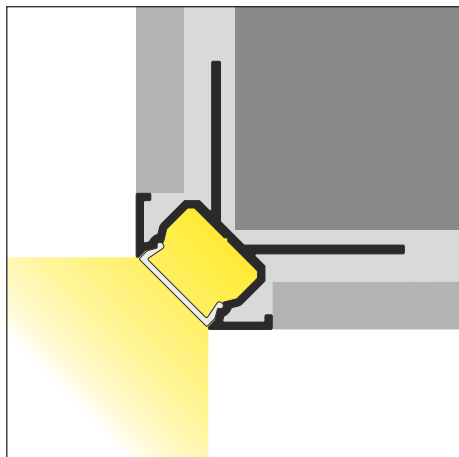
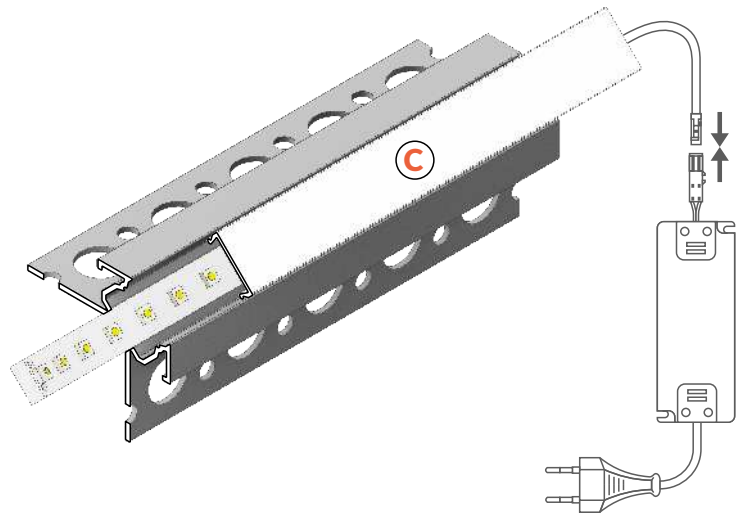

Artikelnummer = 1 Stück, Länge 2.000 mm
 INDEX = 1 pc, length 2000 mm

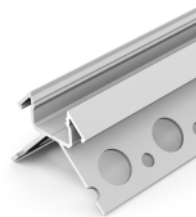

270 Grad PLUS
 eloxiert
 anodized
95G3000620



270 Grad
 eloxiert
 anodized
95G3000220



max 12 mm



spezielle Profile
 special application

Zugängliche Längen der Version PLUS: 1000 mm, 2000 mm, 2500 mm, 3000 mm, 4000 mm.
 Zugängliche Längen der Standardversion: 1000 mm, 2000 mm, 3000 mm, 4000 mm.
 Die standardmäßige Toleranz der Länge von Profilen beträgt: +20 mm.
 Mehr Informationen >> 1.08.

PLUS version available lengths: 1000 mm, 2000 mm, 2500 mm, 3000 mm, 4000 mm.
 Standard version available lengths: 1000 mm, 2000 mm, 3000 mm, 4000 mm.
 The standard profile length tolerance is +20 mm. More details >> 1.08.



ABDECKUNG / COVERS

Abdeckung **C** einclipsbar
Farben: transparent, opal
Material: PMMA

C click cover
colours: transparent, opal
material: PMMA



Achtung! Die Abmessungen des Platzes
für die Montage von LED Lichtquelle
Note! Dimensions of the space
to install LED source

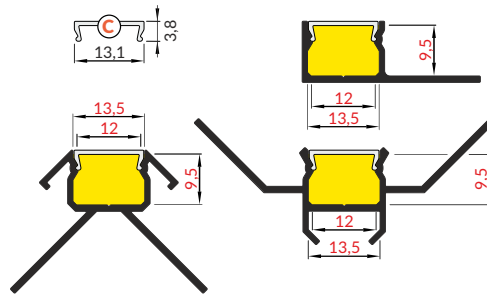

NEU

Länge 2.000 mm,
length 2000 mm

C transparent
Artikelnummer = 1 Stück
index = 1 pc
9576330000

C opal
Artikelnummer = 1 Stück
index = 1 pc
9576330038

Rolle, Länge 20 m,
reel, length 20 m

C opal
Artikelnummer = 1 Stück
index = 1 pc
9576360038S

Die Toleranz der Länge von Abdeckungen beträgt: +20 mm.
Mehr Informationen >> 1.08.

The standard cover length tolerance is +20 mm.
More details >> 1.08.





FRAME14 BC/Q

EIN ALUMINIUM PROFIL FÜR RIGIPSPLETTEN

ALUMINIUM LED PROFILE FOR PLASTERBOARD

- vorgesehen für Rigipsplatten - eine dekorative Ausführung der Konstruktion
- eine homogene Lichtlinie (bei LED Streifen mit 120 leds/m und einer opalen Abdeckung)
- viele Anwendungsmöglichkeiten mit Hilfe von unterschiedlichen Verbindungsstücken.
- maximale Breite des LED Streifens 14 mm

- dedicated for plasterboards - decorative construction finish
- continuous line of light (when using LED strip 120 P/m and opal cover)
- multiple arrangements through a variety of connectors
- maximum LED strip width: 14 mm



ÄHNLICHES IM ANGEBOT / SIMILAR IN THE OFFER



FLAT8
H/UX



DEEP10
BC/UX



WALLE12
CD



UNI-TILE12
90 deg C



UNI-TILE12
180 deg C

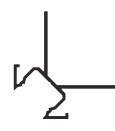

UNI-TILE12
270 deg C



B Abdeckung **B** einschiebbar
B slide cover

C Abdeckung **C** einclipsbar
C click cover

Q¹ Verbindungsstück **Q** 90 Grad gebogen
Q 90 deg bent connector

Q² Verbindungsstück **Q** 180 Grad
Q 180 deg connector

Q³ Verbindungsstück **Q** 135 Grad
Q 135 deg connector

Q⁴ Verbindungsstück **Q** 90 Grad
Q 90 deg connector

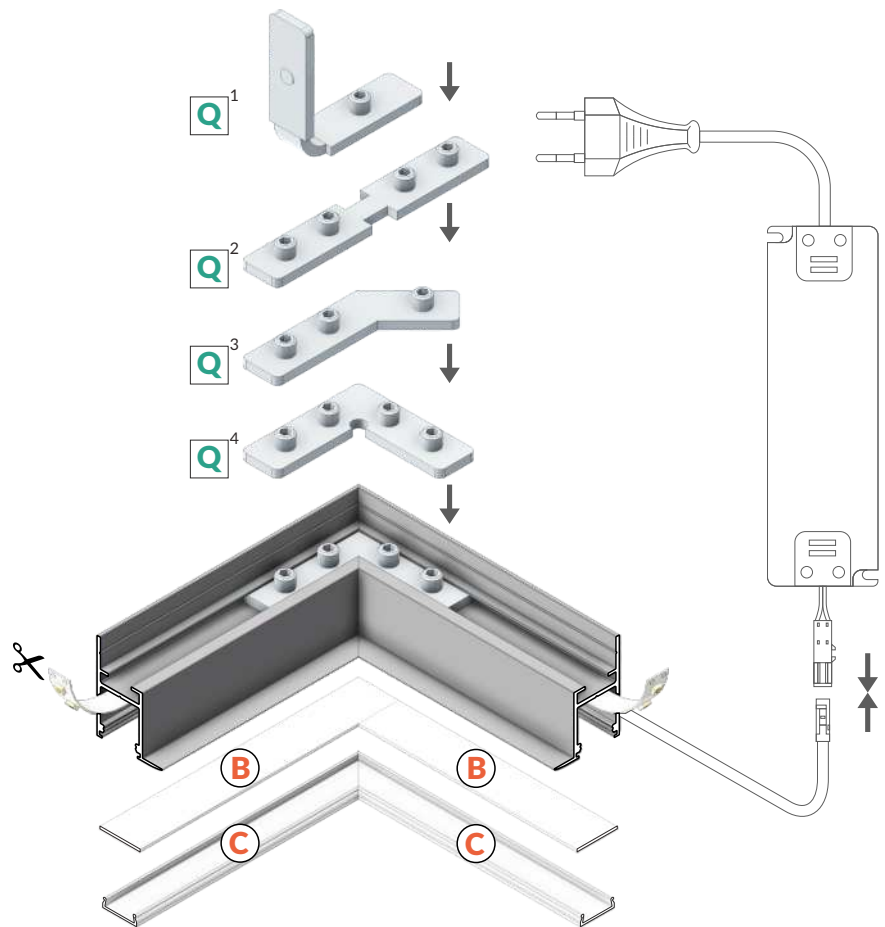
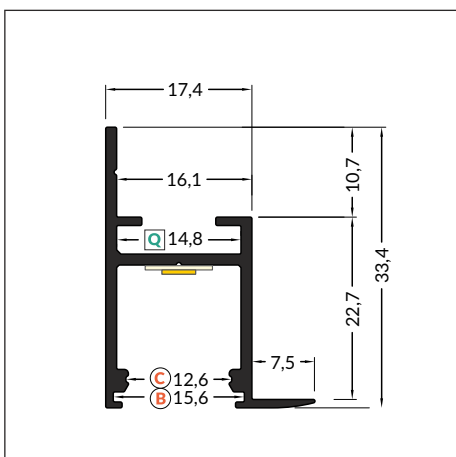
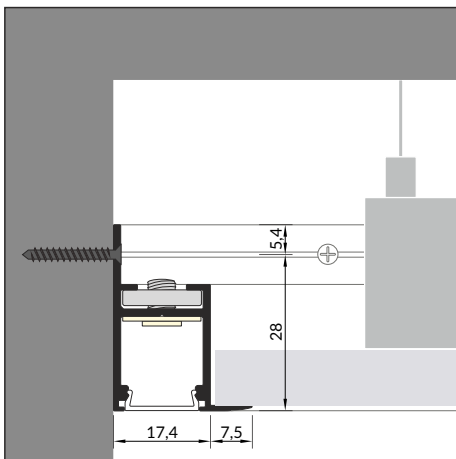
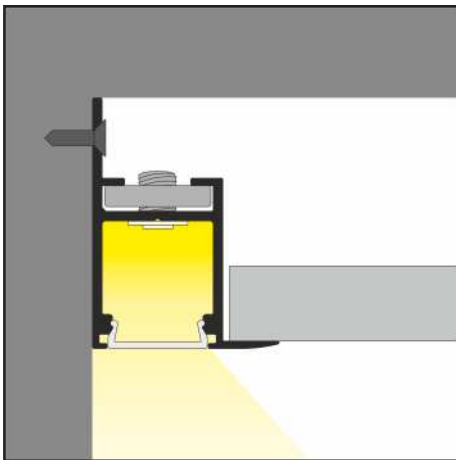

Achtung! Das Profil erfüllt keine Baufunktion.
Please note! The profile isn't a construction profile.

max 14 mm

spezielle Profile
special application



Artikelnummer = 1 Stück,
Länge 2.000 mm,
INDEX = 1 pc, length 2000 mm

weiß lackiert
white painted
95C3020001



eloxiert
anodized
95C3020020



Rohaluminium
raw aluminium
95C3020000

Die zugänglichen Längen: 1000 mm, 2000 mm, 3000 mm, 4000 mm.
Die standardmäßige Toleranz der Länge von Profilen beträgt: +20 mm.
Mehr Informationen >> 1.08.

Available lengths: 1000 mm, 2000 mm, 3000 mm, 4000 mm.
The standard profile length tolerance is +20 mm.
More details >> 1.08.



ABDECKUNG / COVERS

Abdeckung B einziehbar
Farben: transparent, satiniert, opal
Material: PC, PP, PP

B slide cover
colours: transparent, frosted, opal
material: PC, PP, PP

Abdeckung C einclipsbar
Farben: transparent, opal
Material: PMMA

C click cover
colours: transparent, opal
material: PMMA

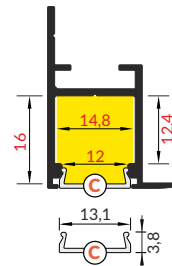

Länge 2.000 mm,
length 2000 mm

B transparent
Artikelnummer = 10 Stück
index = 10 pcs
9576250016

B satiniert / B frosted
Artikelnummer = 10 Stück
index = 10 pcs
9576250039

B opal
Artikelnummer = 10 Stück
index = 10 pcs
9576250038

C transparent
Artikelnummer = 1 Stück
index = 1 pc
9576330000

C opal
Artikelnummer = 1 Stück
index = 1 pc
9576330038

Rolle, Länge 20 m,
reel, length 20 m

C opal
Artikelnummer = 1 Stück
index = 1 pc
9576360038S

NEU

Die Toleranz der Länge von Abdeckungen beträgt: +20 mm.
Mehr Informationen >> 1.08.
The standard cover length tolerance is +20 mm.
More details >> 1.08.

VERBINDUNGSTÜCKE / CONNECTORS

Verbindungsstück Q
180 Grad / 135 Grad / 90 Grad
Material: verzinkter Stahl

Q 180 deg / 135 deg / 90 deg connector
material: zinc coated steel

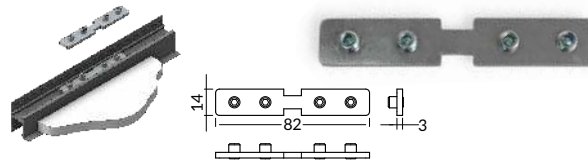

Artikelnummer = 1 Set,
INDEX = 1 set
95C3990030

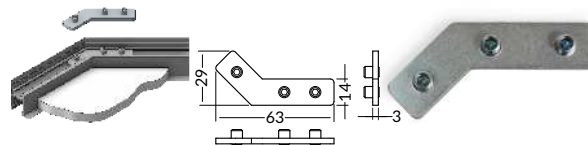

95C3980030

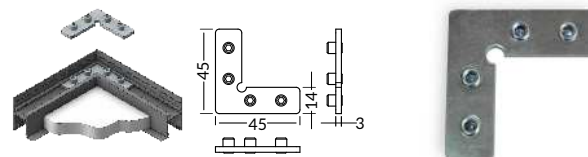

95C3970030

Verbindungsstück Q 90 Grad gebogen
Material: verzinkter Stahl

Q 90 deg bent connector
material: zinc coated steel

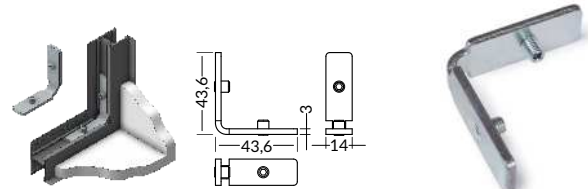

95C3960030



OVAL20 BC

SCHRANKSTANGE MIT ZWEI FUNKTIONEN

A DOUBLE-FUNCTION BAR FOR WARDROBES

- Kleiderstange und Schrankbeleuchtung
 - drei Montagemöglichkeiten: von Wand zu Wand, als Wandausleger, als Deckenausleger
 - zwei Stufen des Einbaus von LED Streifen zur Wahl
 - maximale Breite des LED Streifens 20 mm
-
- a bar for hanging garments and illuminating the wardrobe
 - 3 mounting options: side-to-side, as an extension arm from a side, as an extension arm from the top
 - two LED strip installation depths to choose from
 - maximum LED strip width: 20 mm

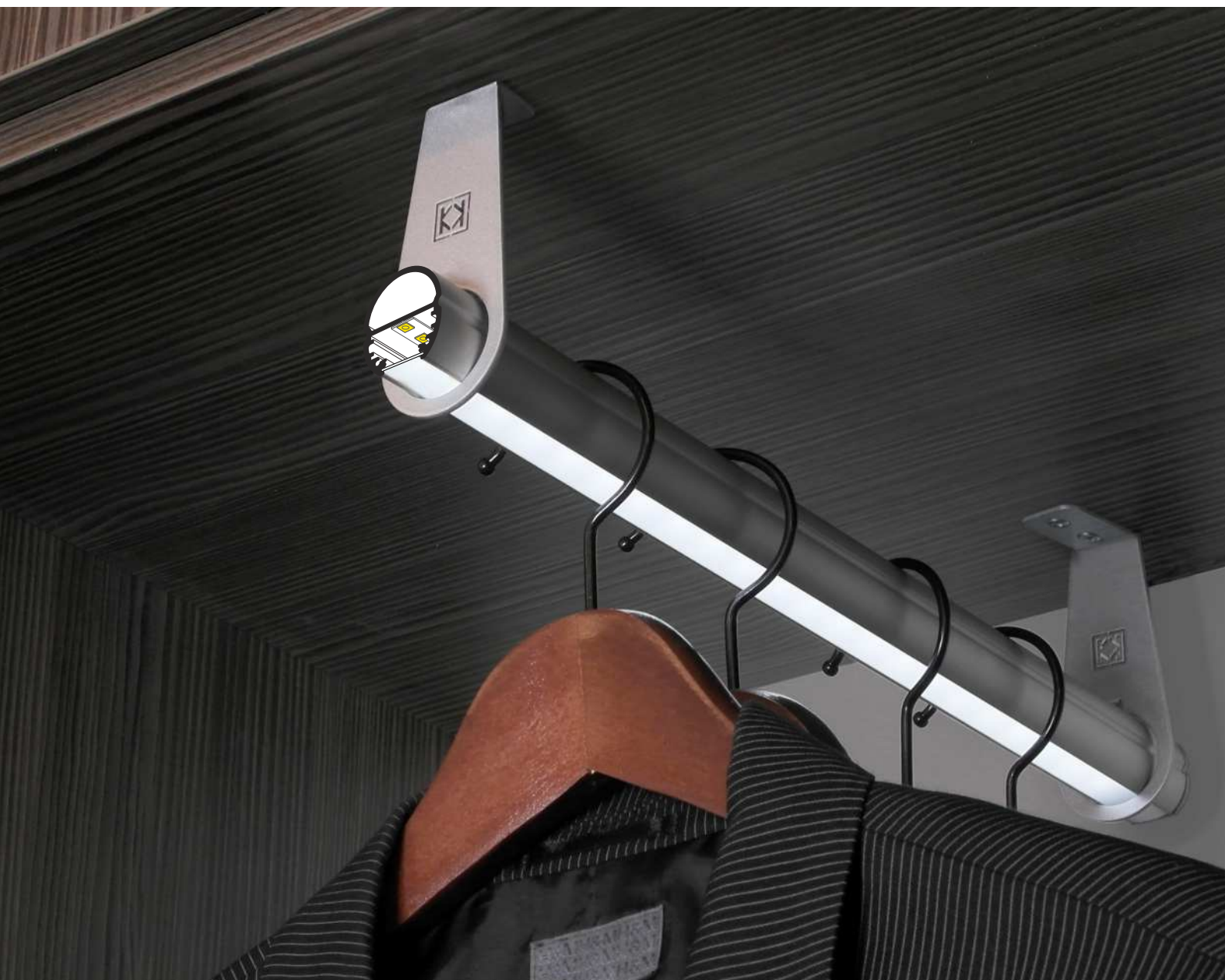

ÄHNLICHES IM ANGEBOT / SIMILAR IN THE OFFER



PEN8



PEN12



B Abdeckung **B** einschiebbar
B slide cover

C Abdeckung **C** einclipsbar
C click cover

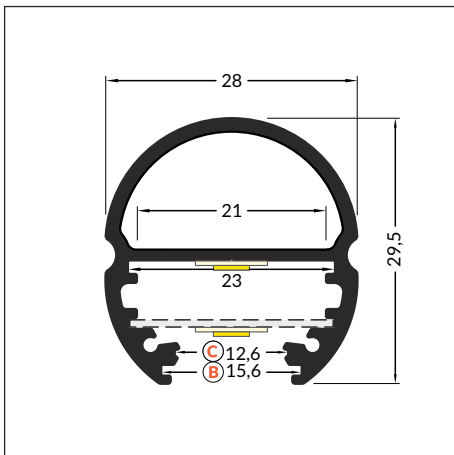
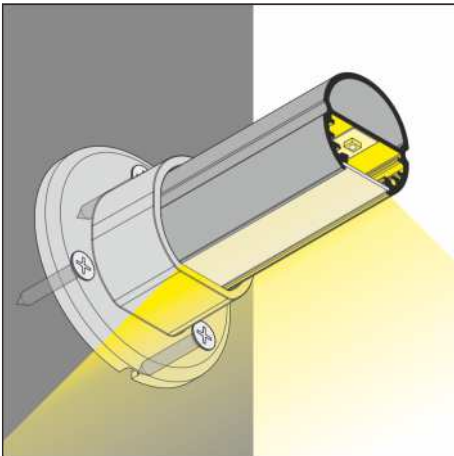
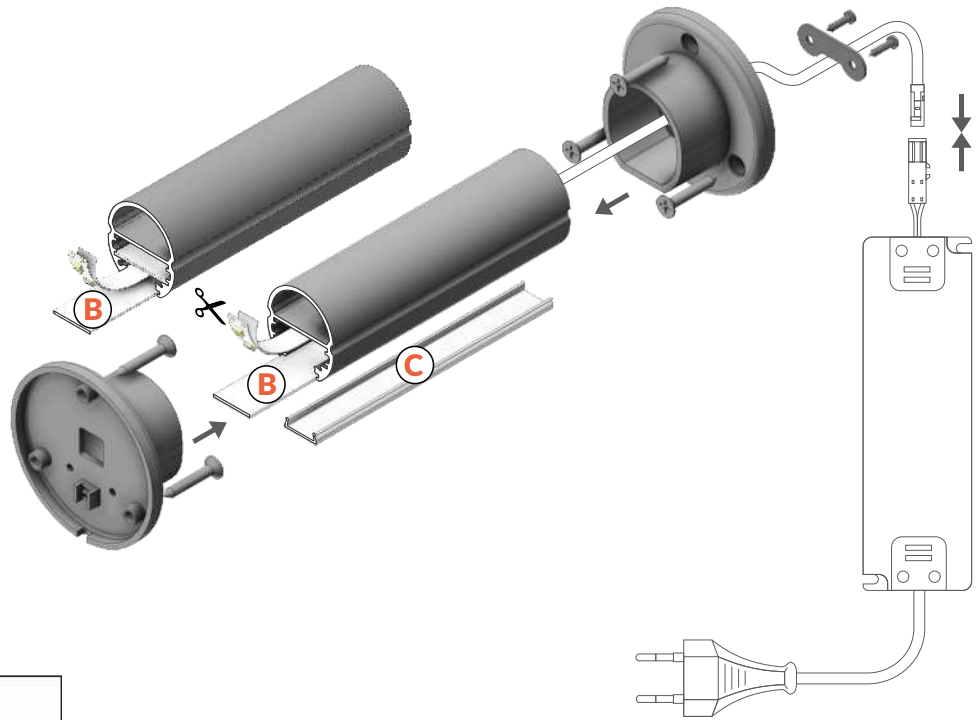

 max 20 mm

 spezielle Profile
special application

Artikelnummer = 1 Stück,
Länge 2.000 mm,
INDEX = 1 pc, length 2000 mm

eloxiert
anodized
9592030020



Die zugänglichen Längen: 1000 mm, 2000 mm, 3000 mm, 4000 mm.
Die standardmäßige Toleranz der Länge von Profilen beträgt: +20 mm.
Mehr Informationen >> 1.08.

Available lengths: 1000 mm, 2000 mm, 3000 mm, 4000 mm.
The standard profile length tolerance is +20 mm.
More details >> 1.08.



ABDECKUNG / COVERS

Abdeckung B einziehbar
Farben: transparent, satiniert, opal
Material: PC, PP, PP

B slide cover
colours: transparent, frosted, opal
material: PC, PP, PP



Achtung! Die Abmessungen des Platzes für die Montage von LED Lichtquelle
Note! Dimensions of the space to install LED source

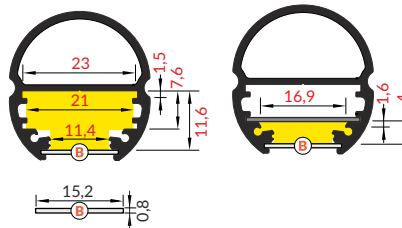

Abdeckung C einclipsbar
Farben: transparent, opal
Material: PMMA

C click cover
colours: transparent, opal
material: PMMA

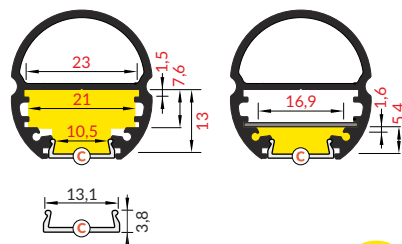

NEU



Länge 2.000 mm,
length 2000 mm

B transparent
Artikelnummer = 10 Stück
index = 10 pcs
9576250016

B satiniert / B frosted
Artikelnummer = 10 Stück
index = 10 pcs
9576250039

B opal
Artikelnummer = 10 Stück
index = 10 pcs
9576250038

C transparent
Artikelnummer = 1 Stück
index = 1 pc
9576330000

C opal
Artikelnummer = 1 Stück
index = 1 pc
9576330038

Rolle, Länge 20 m,
reel, length 20 m

C opal
Artikelnummer = 1 Stück
index = 1 pc
9576360038S

Die Toleranz der Länge von Abdeckungen beträgt: +20 mm.
Mehr Informationen >> 1.08.

The standard cover length tolerance is +20 mm.
More details >> 1.08.

HALTER / MOUNTINGS

Seitenhalter OVAL20
Farben: silbern, grau
Material: ABS

OVAL20 side holder
colours: silver, grey
material: ABS

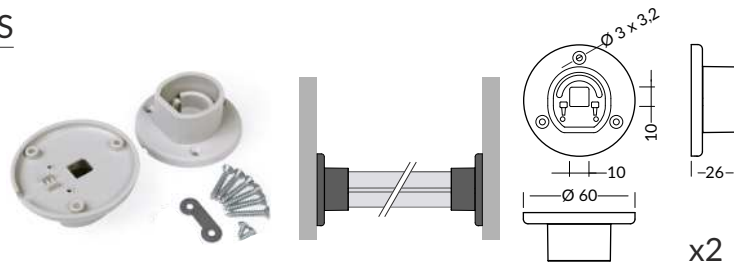

Artikelnummer = 1 Set,
INDEX = 1 set

silbern / silver
9592040040

grau / grey
9592040022

Einzelausleger für OVAL20
Farben: silbern
Material: ABS, Stahl, Aluminium

OVAL20 single extension arm
colour: silver
material: ABS, steel, aluminium

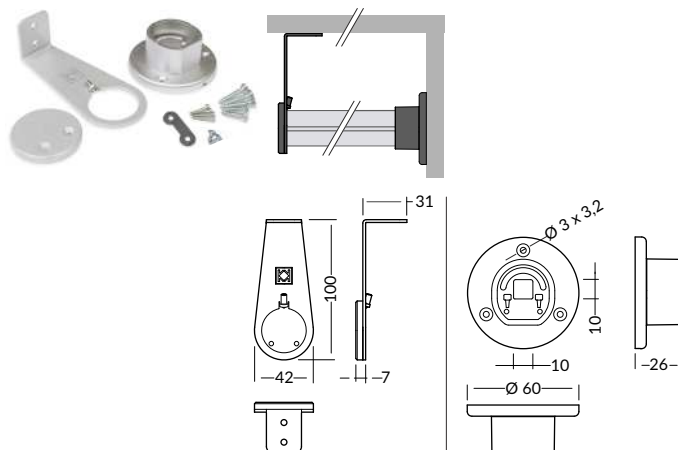

silbern / silver
9592980040



HALTER / MOUNTINGS

Doppelausleger für OVAL20
Farben: silbern
Material: ABS, Stahl, Aluminium
 OVAL20 double extension arm
 colour: silver
 material: ABS, steel, aluminium

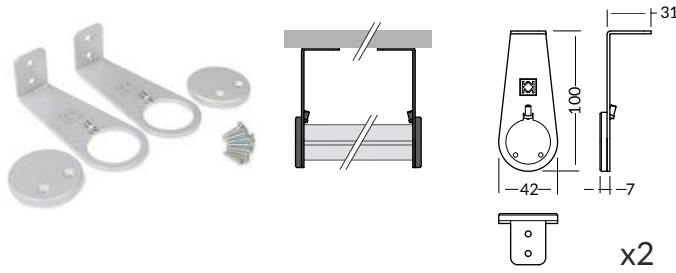

Artikelnummer = 1 Set,
INDEX = 1 set

silbern / silver
9592990040

Halter OVAL20 einfach
Material: verzinkter Stahl
 OVAL20 simple holder
 material: zinc coated steel



verzinkt
zinc coated
9592070030

MONTAGETEIL FÜR LED / LED MOUNTING

LED Montageteil für OVAL20
Material: Aluminium
 OVAL20 LED mounting
 material: aluminium

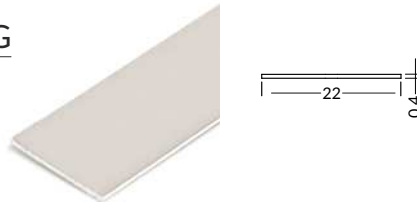

Artikelnummer = 1 Stück,
Länge 2.000 mm,
INDEX = 1 pc, length 2000 mm

Rohaluminium
raw aluminium
9592100000

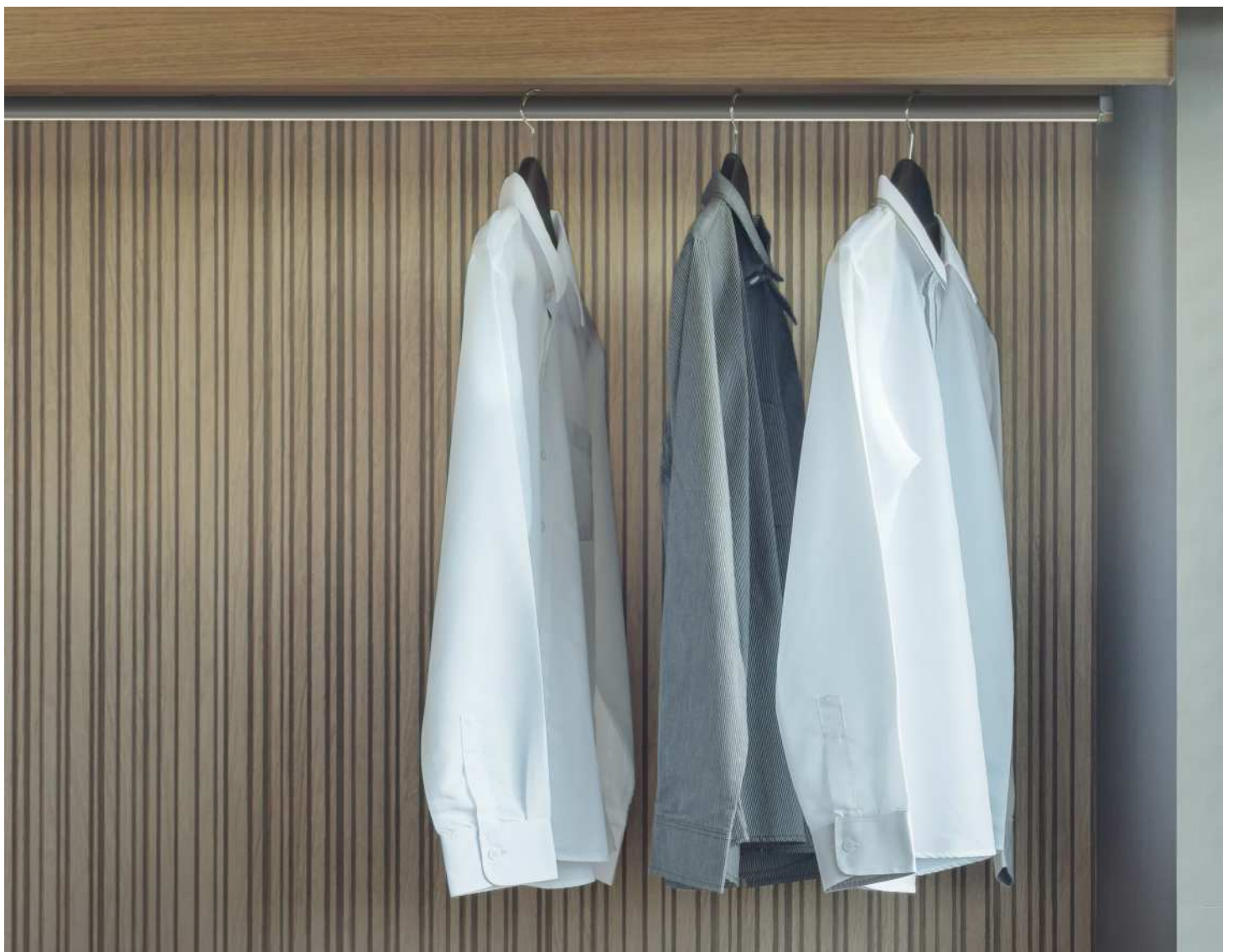

TWIN8

KANTENPROFIL FÜR GLASBRETT - LEUCHTET IN ZWEI RICHTUNGEN

A TWO-WAY EDGE PROFILE FOR GLASS SHELVES

- **dekorative Beleuchtung**
 - **die Montage an dem hinteren Glas-, Brettrand**
 - **zwei Leuchtrichtungen: nach oben und unten**
 - **es beleuchtet die innere Wand der Vitrine**
 - **zusätzlich die Beleuchtung des Glasrandes in der Version TWIN8 PLUS**
 - **geeignet für 8mm Glasböden**
 - **die Möglichkeit der Anwendung mit einer dünneren Scheibe - hierbei muss ein zusätzliches Montageband verklebt werden**
 - **Achtung: das Profil dient nicht als Konstruktions- /Montageelement**
 - **maximale Breite des LED Streifens 8 mm**
-
- decorative illumination
 - mounted on the glass or shelf rear edge
 - 2 lighting directions: up and down
 - illuminating the rear side of a display case
 - additionally illumination of the glass edge with the TWIN8 PLUS profile
 - fits the 8 mm thick glass panel
 - when using on a thinner glass, consider additional adhesive tape
 - note: the profile is not a construction element
 - maximum LED strip width: 8 mm

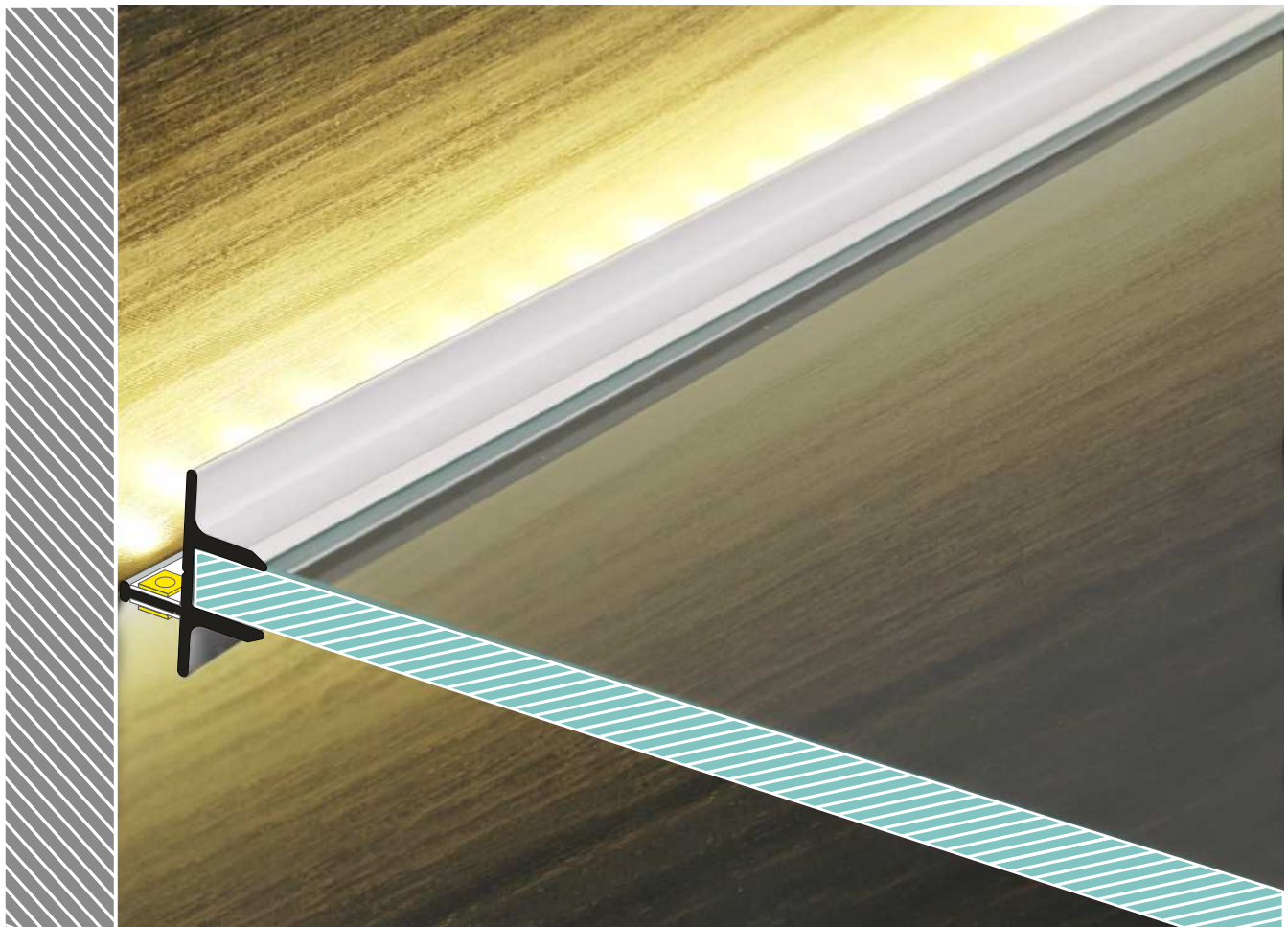

ÄHNLICHES IM ANGEBOT / SIMILAR IN THE OFFER



BACK10
A/UX



EDGE10
BC



MIKRO10



MIKRO-LINE12



CABI12
E

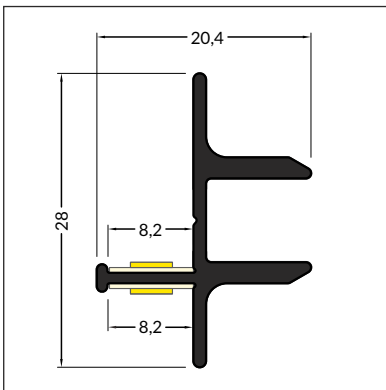

max 8 mm



Glaskantenprofile
glass application

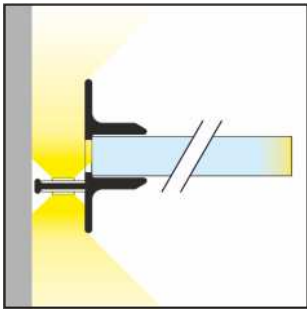
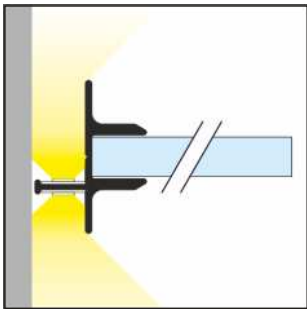
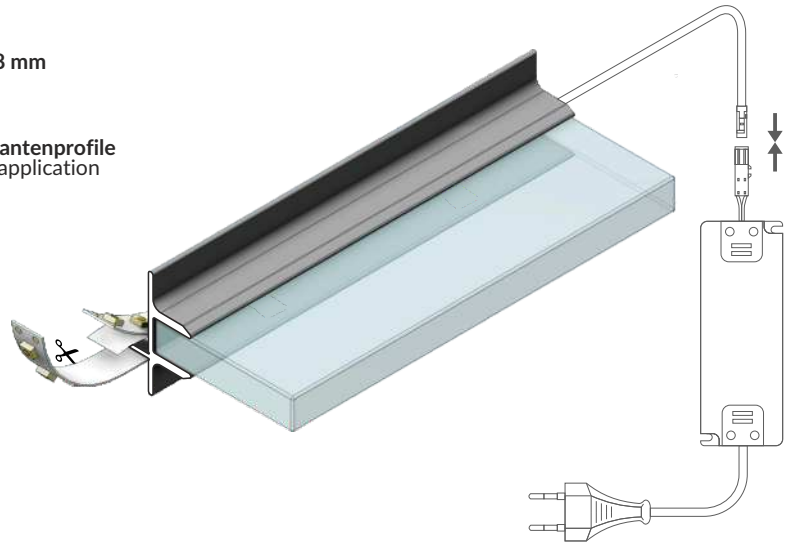

Artikelnummer = 1 Stück,
Länge 2.000 mm,
INDEX = 1 pc, length 2000 mm

TWIN8
Rohaluminium
raw aluminium
9582150000

TWIN8 PLUS
Rohaluminium
raw aluminium
9582160000

Die zugänglichen Längen: 1000 mm, 2000 mm, 3000 mm, 4000 mm. Die standardmäßige Toleranz der Länge von Profilen beträgt: +20 mm. Mehr Informationen >> 1.08.

Available lengths: 1000 mm, 2000 mm, 3000 mm, 4000 mm. The standard profile length tolerance is +20 mm. More details >> 1.08.

WÄRMELEITBAND / THERMAL TAPE

Wärmeleitband 45 x 10 mm
doppelseitiges Klebeband

thermal tape 45 x 10 mm
self adhesive, double-sided

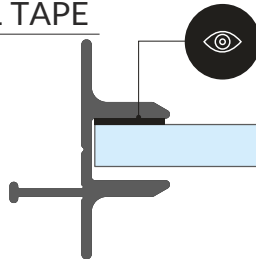

Artikelnummer = 1 Stück,
INDEX = 1 pc

9553820000



MIKRO10

EIN KLEINES GLASKANTENPROFIL

A SMALL EDGE PROFILE FOR GLASS PANELS

- für die Beleuchtung von Glaskanten oder der Gravur auf der Scheibenfläche
- geeignet hauptsächlich für Möbel (Vitrinen) und Werbebereich
- eine dezente Form
- geeignet für 6 mm Glasböden
- **Achtung: das Profil erfüllt keine Baufunktion**
- maximale Breite des LED Streifens 10 mm
- to illuminate the edge or engraving on the glass panel surface
- to be used for furniture (display cases) or advertising
- discreet form
- fits the 6 mm thick glass panel
- note: the profile is not a construction element
- maximum LED strip width: 10 mm

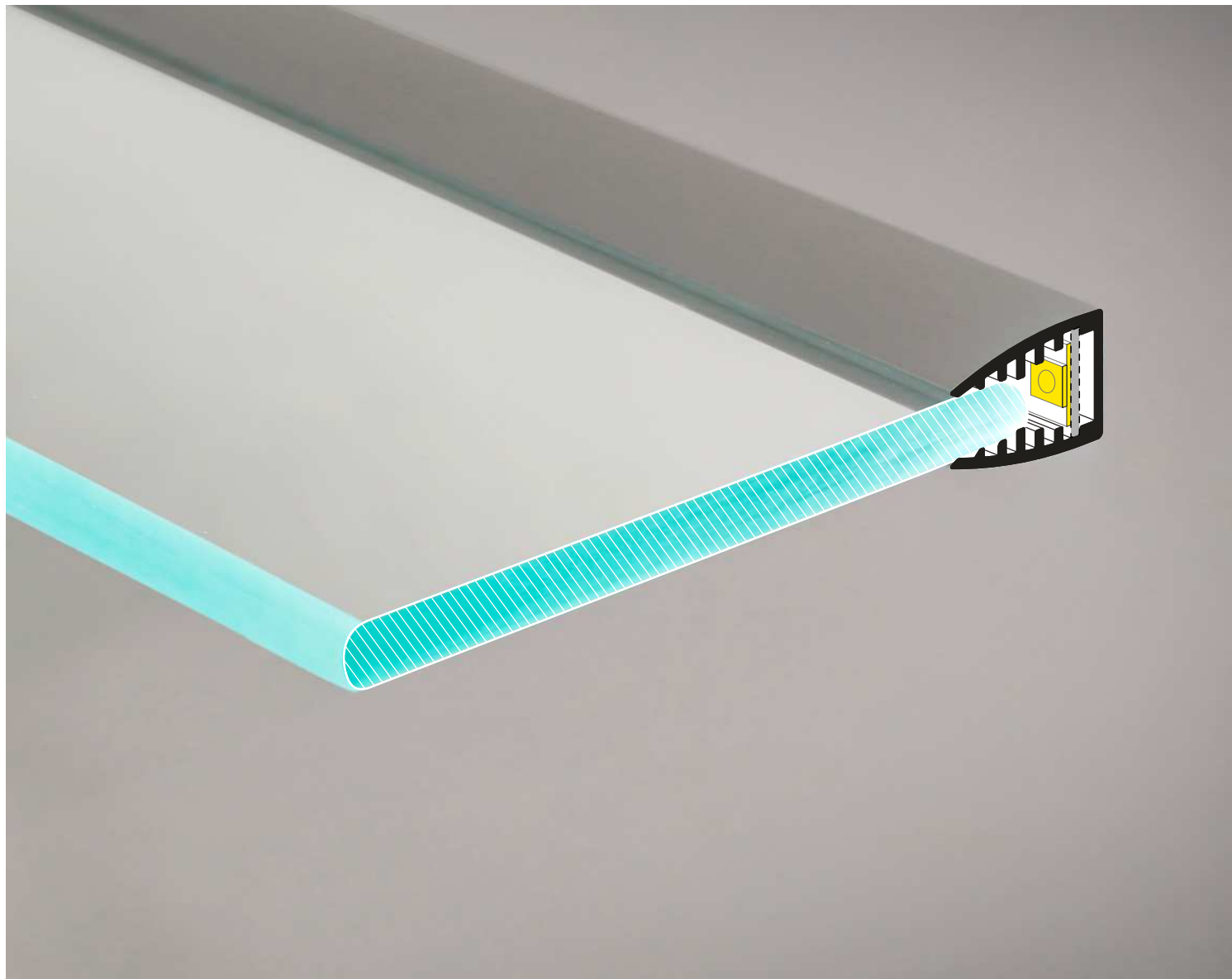

ÄHNLICHES IM ANGEBOT / SIMILAR IN THE OFFER



TWIN8



EDGE10
BC



MIKRO-LINE12



CABI12
E

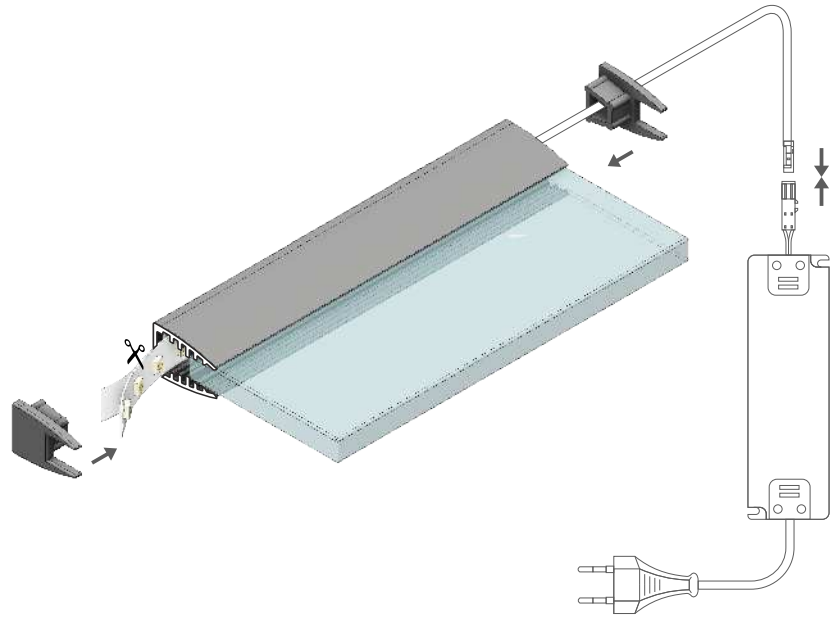
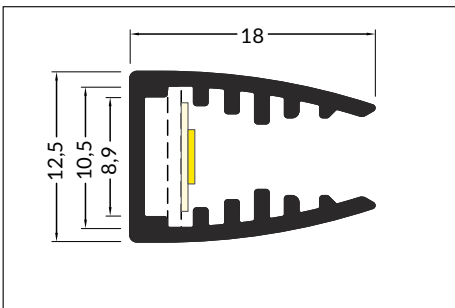
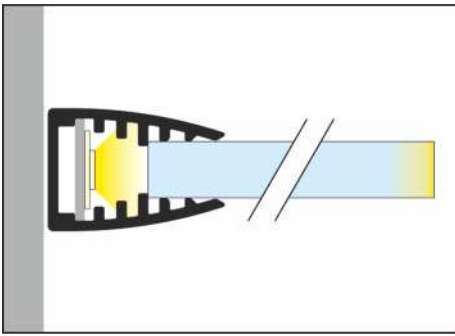

max 10 mm



Glaskantenprofile
glass application



Artikelnummer = 1 Stück,
Länge 2.000 mm,
INDEX = 1 pc, length 2000 mm

**eloxiert /
anodized
9568540020**

Die zugänglichen Längen: 1000 mm, 2000 mm,
3000 mm, 4000 mm. Die standardmäßige Tole-
ranz der Länge von Profilen beträgt: +20 mm.
Mehr Informationen >> 1.08.

Available lengths: 1000 mm, 2000 mm,
3000 mm, 4000 mm. The standard profile length
tolerance is +20 mm.
More details >> 1.08.

ENDKAPPEN / ENDINGS

Endkappe MIKRO10
Farben: silbern, grau, transparent
Material: ABS, ABS, PC
MIKRO10 ending
colours: silver, grey, transparent
material: ABS, ABS, PC

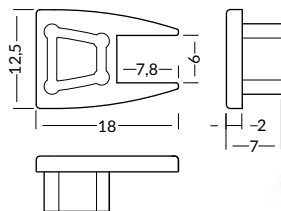

Artikelnummer = 10 Sets = 20 Stück
INDEX = 10 sets = 20 pcs

silbern / silver
9568550040

grau / grey
9568550022

transparent
9568550000

MONTAGETEIL FÜR LED / LED MOUNTING

Montageteil für LED MIKRO10
Material: HIPS
MIKRO10 LED mounting
material: HIPS

Artikelnummer = 1 Stück,
Länge 2.000 mm,
INDEX = 1 pc, length 2000 mm

9568640000

die zugänglichen Längen
Available lengths
1000 mm, 2000 mm



EDGE10 BC

DIE AUSFÜHRUNG DES RANDES UND BELUCHTUNG DER AUSSTELLUNG

FINISHING EDGES AND LIGHTING OF DISPLAY WINDOWS

- dient als Abschlussprofil für Scheiben mit der Dicke von 8mm
- es ermöglicht einen Rahmen um die Scheibe herum zu bauen
- das Licht wird in einem Winkel emittiert - es verursacht keine Blendung
- die Beleuchtung erfolgt von oben oder von unten
- eine einfache Montage durch Einkleben - unsichtbare Befestigung mit einem doppelseitigen Montageband
- bei der Anwendung mit einer dünneren Scheibe muss man das Verkleben eines zusätzlichen Montagebandes vorsehen
- maximale Breite des LED Streifens 10 mm

- the product for finishing and strengthening display window edges to a thickness up to 8 mm
- suitable for decorative 'framing' of the display window
- light is emitted at an angle - it does not cause glare
- top or bottom illumination
- easy installation - a double-sided tape not visible to customers
- when using on a thinner glass, consider additional wedging or adhesive tape
- maximum LED strip width: 10 mm

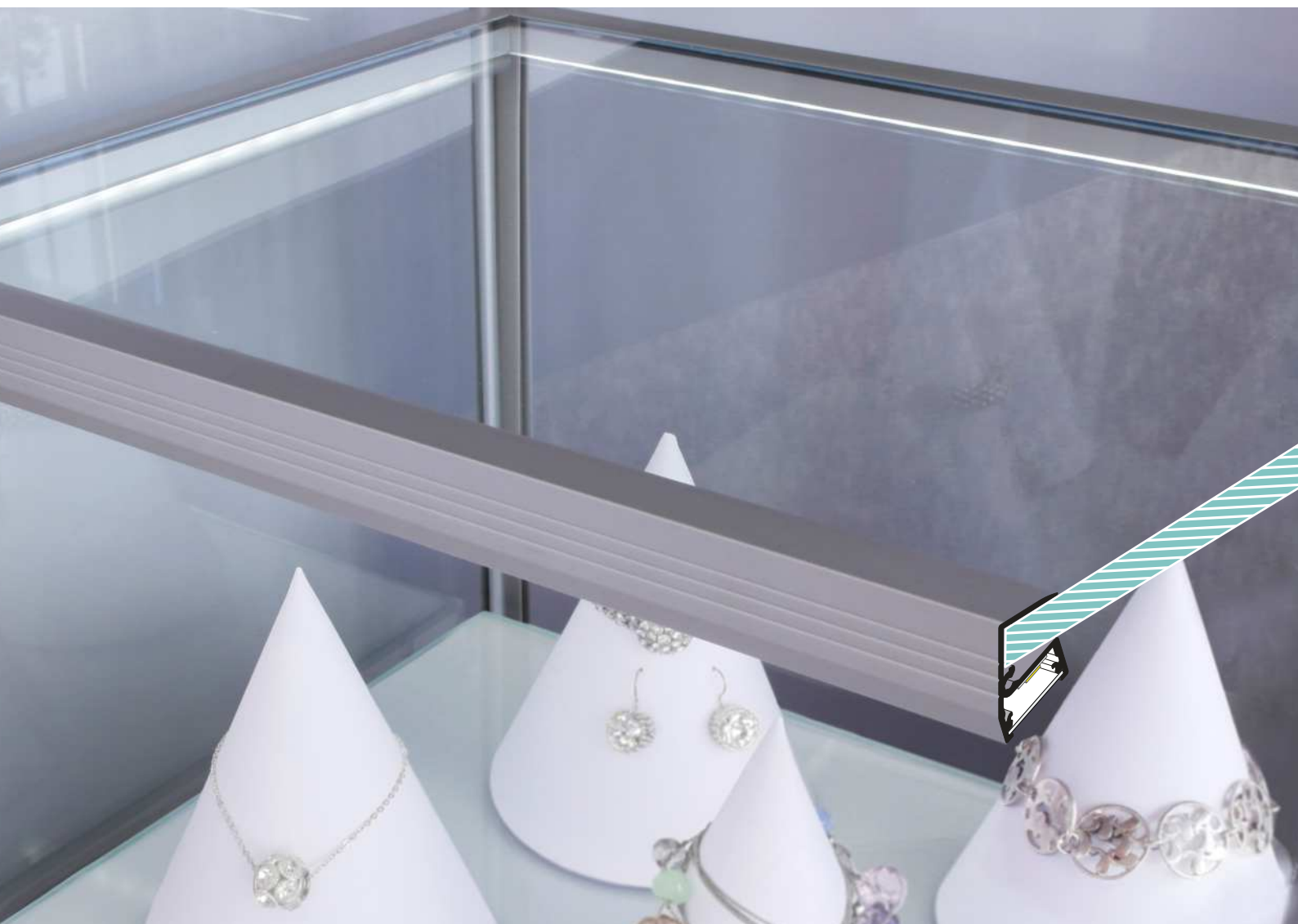

ÄHNLICHES IM ANGEBOT / SIMILAR IN THE OFFER



TWIN8



MIKRO10



MIKRO-LINE12



FRAME14
BC/Q



CABI12
E



- B** Abdeckung **B** einschiebbar
B slide cover
- C** Abdeckung **C** einclipsbar
C click cover
- C** Abdeckung **C** einclipsbar Linse
C lens cover

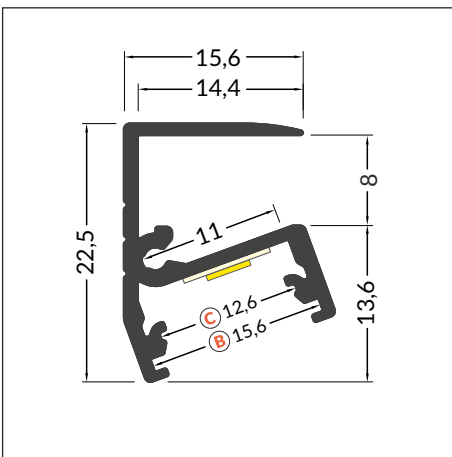
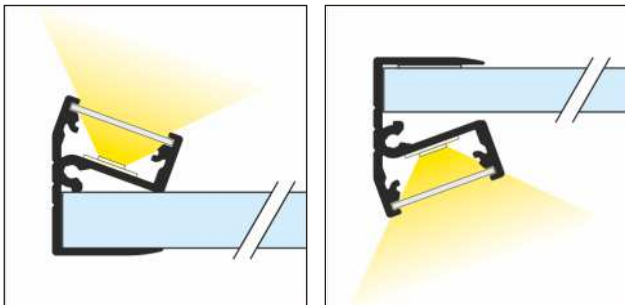
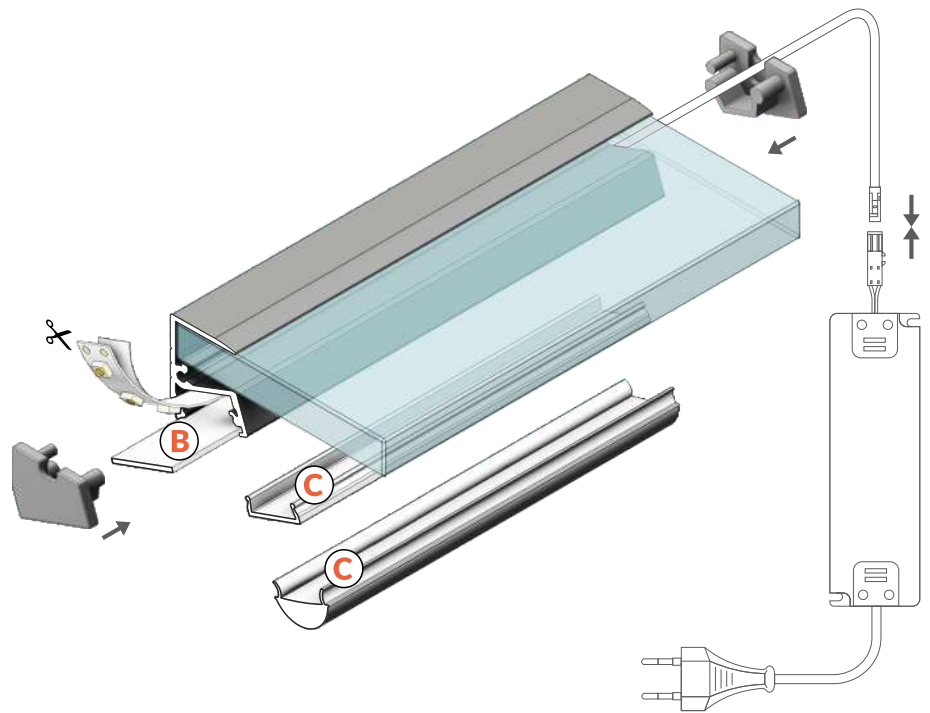

max 10 mm



Glaskantenprofile
glass application



Artikelnummer = 1 Stück,
Länge 2.000 mm,
INDEX = 1 pc, length 2000 mm

weiß lackiert
white painted
95A9020001

eloxiert
anodized
95A9020020

schwarz eloxiert
black anodized
95A9020021

Rohaluminium
raw aluminium
95A9020000

Die zugänglichen Längen: 1000 mm, 2000 mm, 3000 mm, 4000 mm.
Die standardmäßige Toleranz der Länge von Profilen beträgt: +20 mm.
Mehr Informationen >> 1.08.

Available lengths: 1000 mm, 2000 mm, 3000 mm, 4000 mm.
The standard profile length tolerance is +20 mm.
More details >> 1.08.



ABDECKUNG / COVERS

Abdeckung B einziehbar
Farben: transparent, satiniert, opal
Material: PC, PP, PP

B slide cover
colours: transparent, frosted, opal
material: PC, PP, PP



Achtung! Die Abmessungen des Platzes für die Montage von LED Lichtquelle
Note! Dimensions of the space to install LED source

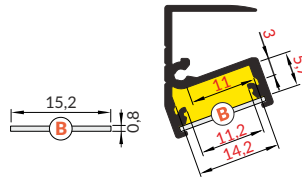

Länge 2.000 mm,
length 2000 mm

B transparent
Artikelnummer = 10 Stück
index = 10 pcs
9576250016



B satiniert / B frosted
Artikelnummer = 10 Stück
index = 10 pcs
9576250039

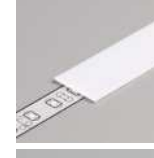

B opal
Artikelnummer = 10 Stück
index = 10 pcs
9576250038



C transparent
Artikelnummer = 1 Stück
index = 1 pc
9576330000



C opal
Artikelnummer = 1 Stück
index = 1 pc
9576330038

Abdeckung C einclipsbar
Farben: transparent, opal
Material: PMMA

C click cover
colours: transparent, opal
material: PMMA

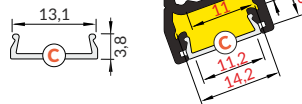

Rolle, Länge 20 m,
reel, length 20 m

C opal
Artikelnummer = 1 Stück
index = 1 pc
9576360038S

Abdeckung C einclipsbar Linse
Farbe: transparent
Material: PC

C lens click cover
colour: transparent
material: PC

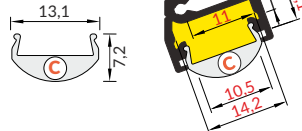

Länge 2.000 mm,
length 2000 mm

C Linse / C lens
Artikelnummer = 1 Stück
index = 1 pc
9576300000

Die Toleranz der Länge von Abdeckungen beträgt: +20 mm.
Mehr Informationen >> 1.08.
The standard cover length tolerance is +20 mm.
More details >> 1.08.



ENDKAPPEN / ENDINGS

Endkappe EDGE10 gen2 mit Öffnung
Farben: weiß, silbern, schwarz, grau
Material: ABS

EDGE10 ending gen2 with hole
colours: white, silver, black, grey
material: ABS

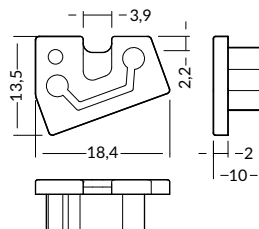

Artikelnummer = 10 Sets = 20 Stück
INDEX = 10 sets = 20 pcs

weiß / white
95A9950001
silbern / silver
95A9950040
schwarz / black
95A9950002
grau / grey
95A9950022

WÄRMELEITBAND / THERMAL TAPE

Wärmeleitband 45 x 10 mm
doppelseitiges Klebeband

thermal tape 45 x 10 mm
self adhesive, double-sided

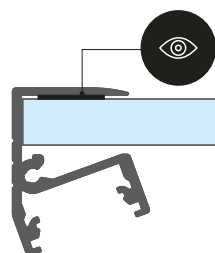

Artikelnummer = 1 Stück,
INDEX = 1 pc

9553820000



Abhängig von der Montage-
weise gibt das Profil EDGE10
die Möglichkeit der Beleuch-
tung der Ausstellung
von oben oder von unten.

Depending on the installation
method, EDGE10 profile may
illuminate the display area
from the top or from below.



MIKRO-LINE12 J

EIN GLASKANTENPROFIL

EDGE PROFILE FOR GLASS PANELS

- dekorative Beleuchtung
- es beleuchtet eine Kante oder die Gravur auf der Scheibenfläche
- hauptsächlich für die Anwendung in Möbel und Werbung
- geeignet für 8mm Glasböden
- Achtung: das Profil erfüllt keine Baufunktion
- maximale Breite des LED Streifens 12 mm

- decorative illumination
- illuminates the edge or engraving on the glass panel surface
- for furniture and advertisement use mainly
- fits the 8 mm glass panels
- note: the profile is not a construction element
- maximum LED strip width: 12 mm

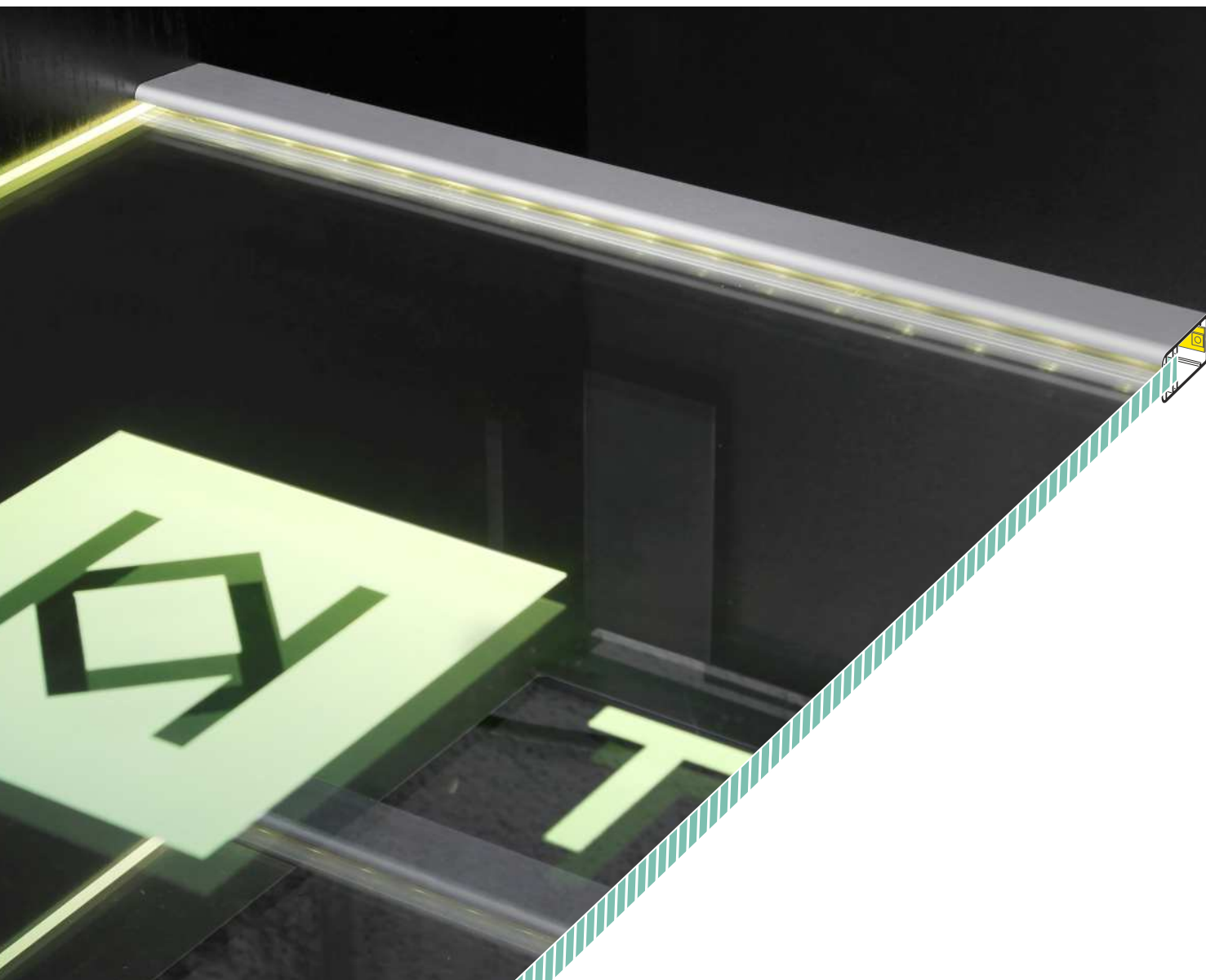

ÄHNLICHES IM ANGEBOT / SIMILAR IN THE OFFER



TWIN8



EDGE10
BC



MIKRO10



CABI12
E

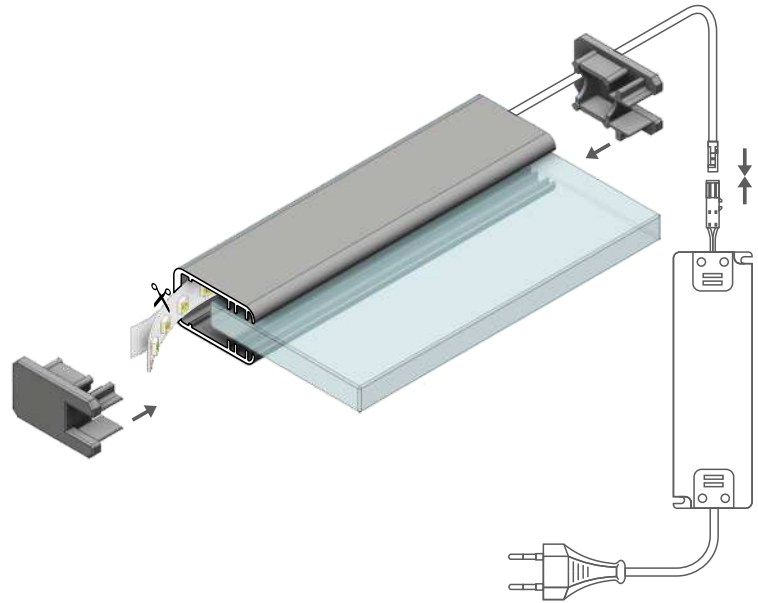
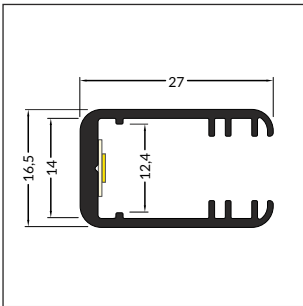
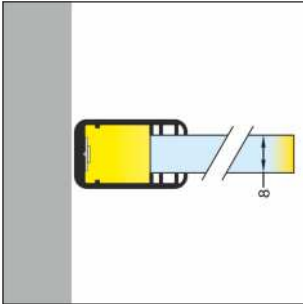

max 12 mm



Glaskantenprofile
glass application



Auf Lager verfügbar
available in stock



Artikelnummer = 1 Stück,
Länge 2.000 mm,
INDEX = 1 pc, length 2000 mm

eloxiert
anodized

9570280020

Rohaluminium
raw aluminium

9570280000

Die zugänglichen Längen: 1000 mm, 2000 mm, 3000 mm, 4000 mm. Die standardmäßige Toleranz der Länge von Profilen beträgt: +20 mm. Mehr Informationen >> 1.08.

Available lengths: 1000 mm, 2000 mm, 3000 mm, 4000 mm. The standard profile length tolerance is +20 mm. More details >> 1.08.

ENDKAPPEN / ENDINGS

Endkappe MIKRO-LINE12

Farben: silbern, grau, transparent

Material: ABS, ABS, PC

MIKRO-LINE12 ending
colours: silver, grey, transparent

material: ABS, ABS, PC

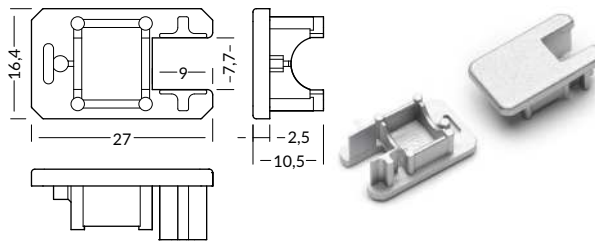

Artikelnummer = 10 Sets = 20 Stück
INDEX = 10 sets = 20 pcs

silbern / silver
9570290040

grau / grey
9570290022

transparent
9570290000



Achtung! Die Abmessungen des Platzes für die Montage von LED Lichtquelle
Note! Dimensions of the space to install LED source

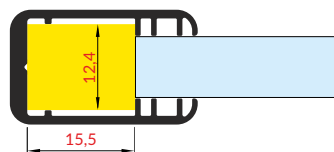

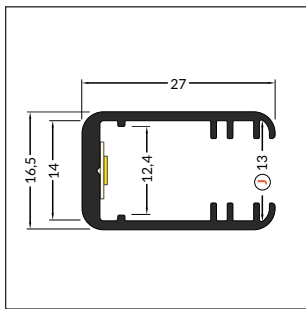
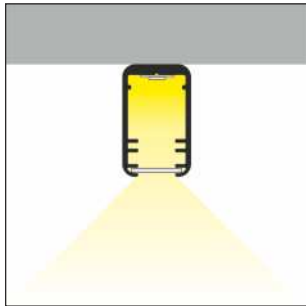

J Abdeckung **J** einziehbar
J slide cover

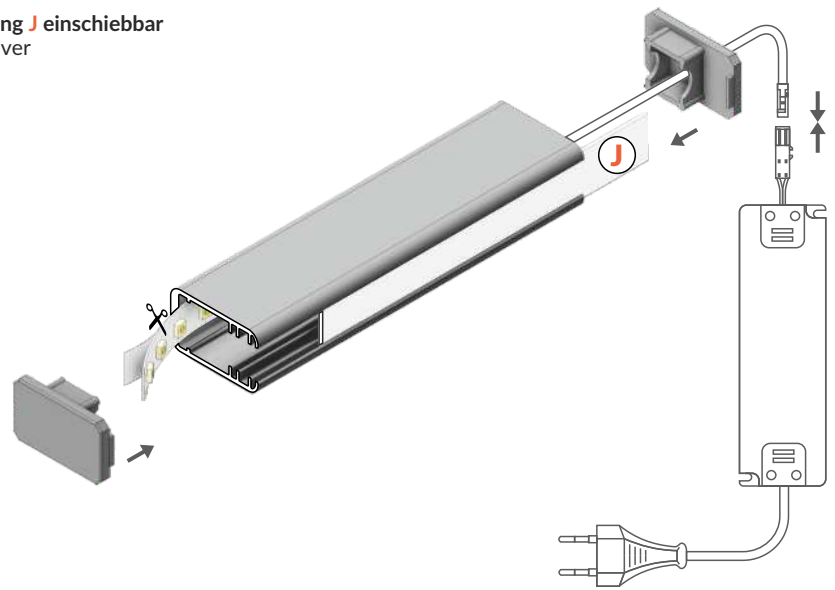

max 12 mm



Glaskantenprofile
 special application



Auf Lager verfügbar
 available in stock



Artikelnummer = 1 Stück,
 Länge 2.000 mm,
 INDEX = 1 pc, length 2000 mm

eloxiert
 anodized

9570280020

Rohaluminium
 raw aluminium

9570280000

Die zugänglichen Längen: 1000 mm, 2000 mm, 3000 mm, 4000 mm. Die standardmäßige Toleranz der Länge von Profilen beträgt: +20 mm. Mehr Informationen >> 1.08.

Available lengths: 1000 mm, 2000 mm, 3000 mm, 4000 mm. The standard profile length tolerance is +20 mm. More details >> 1.08.

ENDKAPPEN / ENDINGS

Endkappe MIKRO-LINE12 LINIA
 Farben: silbern, grau, transparent
 Material: ABS, ABS, PC
 MIKRO-LINE12 LINIA ending
 colours: silver, grey, transparent
 material: ABS, ABS, PC

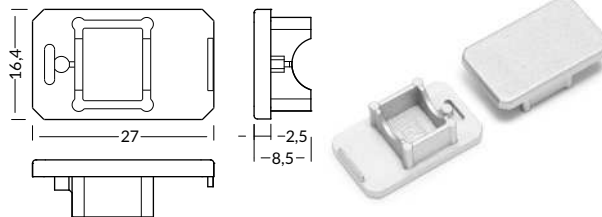

Artikelnummer = 10 Sets = 20 Stück
 INDEX = 10 sets = 20 pcs

silbern / silver
9570300040

grau / grey
9570300022

transparent
9570300000

ABDECKUNG / COVERS

Abdeckung **J** einziehbar
 Farben: transparent, satiniert, opal
 Material: PC, PP, PP

J slide cover
 colours: transparent, frosted, opal
 material: PC, PP, PP

Achtung! Die Abmessungen des Platzes für die Montage von LED Lichtquelle
Note! Dimensions of the space to install LED source

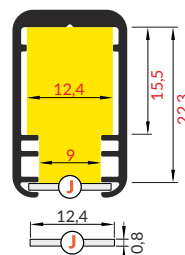

Länge 2.000 mm,
 length 2000 mm

J transparent
 Artikelnummer = 10 Stück
 indeks = 10 pcs
9570330016

J satiniert / **J** frosted
 Artikelnummer = 10 Stück
 indeks = 10 pcs
9570330039

J opal
 Artikelnummer = 10 Stück
 indeks = 10 pcs
9570330038

Die Toleranz der Länge von Abdeckungen beträgt: +20 mm. Mehr Informationen >> 1.08.

The standard cover length tolerance is +20 mm. More details >> 1.08.

**DIE ANWENDUNG DES PROFILS:
PROFILE APPLICATION:**



Mit einer opalen Abdeckung - eine homogene Lichtlinie.
With white cover - continuous light line.



Mit einer Scheibe - die Beleuchtung der sandgestrahlten Kante.
With glass panel - illumination of sandblasted edge.



SYSTEM VON LICHTVARIATIONEN

VARIOUS LIGHT IDEAS

- 18 Varianten und Kombinationen
- von Hänge- bis zu Einbauversionen
- Gehäuse um die Energieversorgung
- eine Lichtlinie in Eckverbindern
- unbegrenzte Möglichkeiten der Lichtgestaltung

- 18 variations and combinations
- from pendant to recessed
- housing around the powering supply
- continuous light line in angular connections
- unlimited possibilities in creating light

Beispiel / an example
variant 18

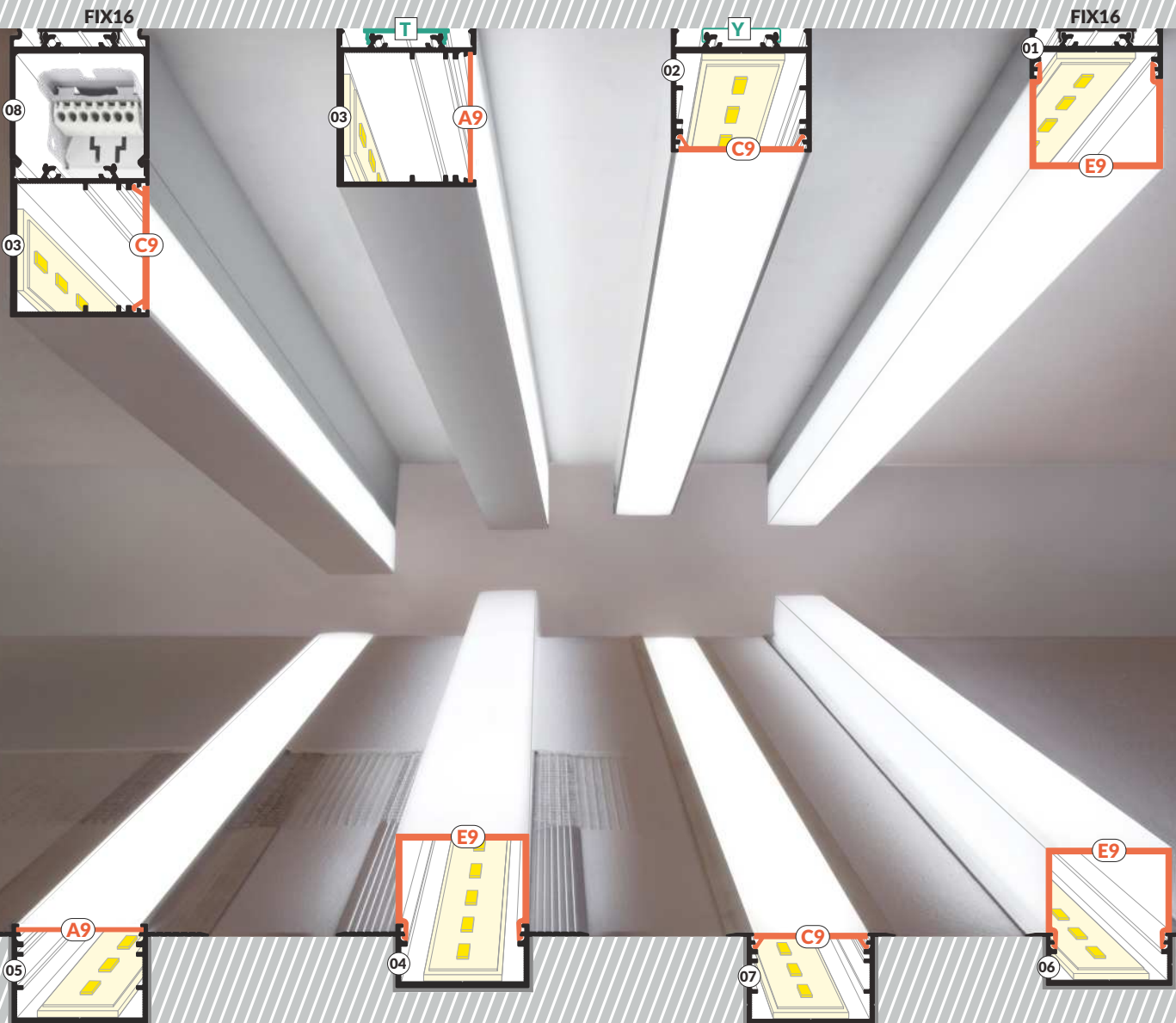
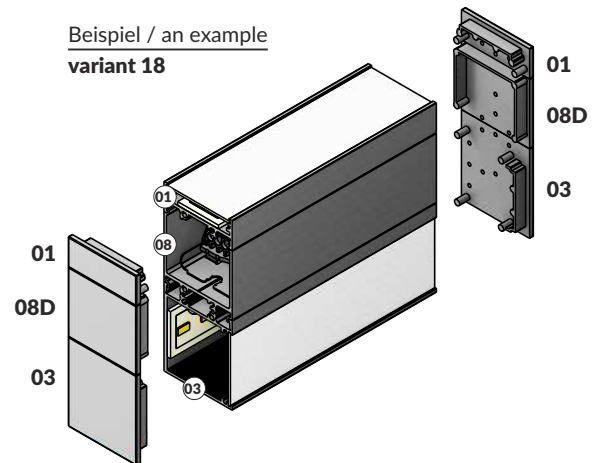

EMPFOHLENE VARIANTEN PROMOTED VARIANTS

Variante 27 - Hängeversion 09-08-02-C9
variant 27 - pendant 09-08-02-C9

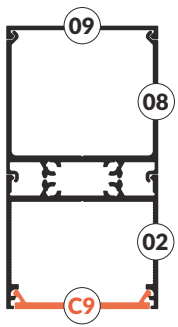

Variante 15 - Deckenversion FIX16-08-01-E9
variant 15 - ceiling FIX16-08-01-E9

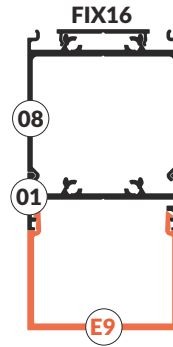

Variante 32 - seitliche Wandversion FIX16-08-03-A9
variant 32 - wall side FIX16-08-03-A9

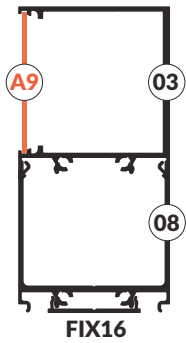

Variante 11 - Möbelversion FIX16-01-C9
variant 11 - furniture FIX16-01-C9



Variante 06 - Einbauversion 06-E9
variant 06 - recessed 06-E9

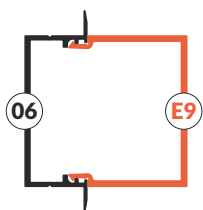

Variante 05 - Einbauversion 05-A9 zum Verputzen
variant 05 - recessed 05-A9 spackle flange

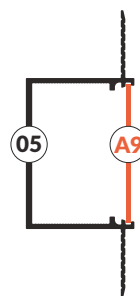

EMPFOHLENE VARIANTEN PROMOTED VARIANTS

BASISVARIANTEN / BASIC VARIANTS

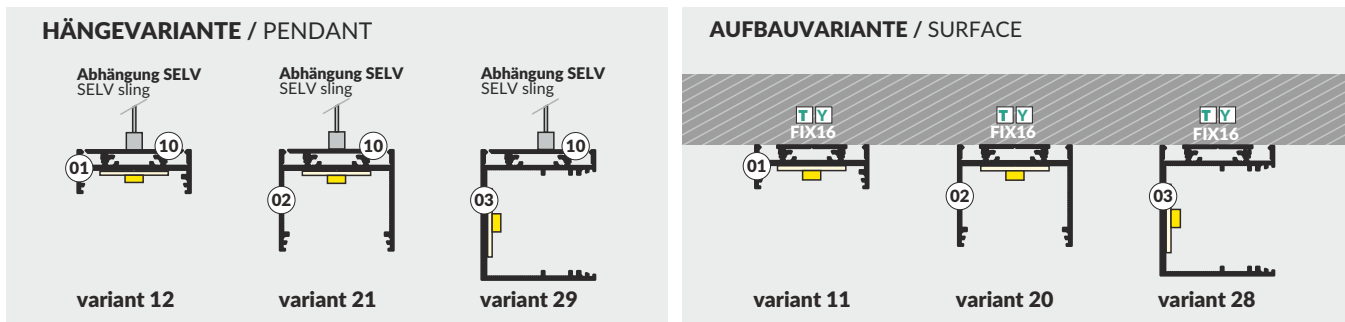

DIE VARIANTEN MIT DEM NETZTEILGEHÄUSE / VARIANTS WITH POWER SUPPLY COVER

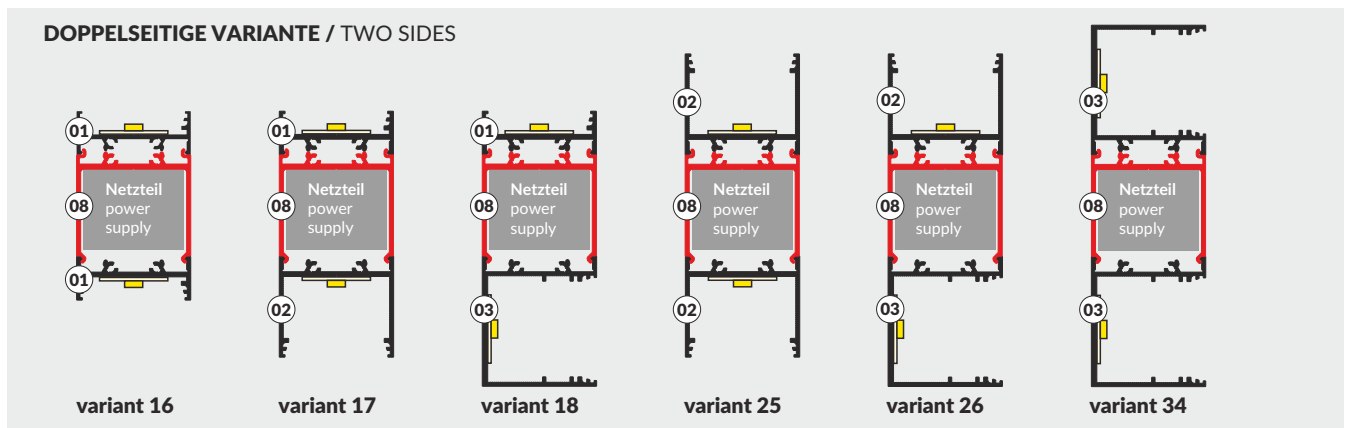
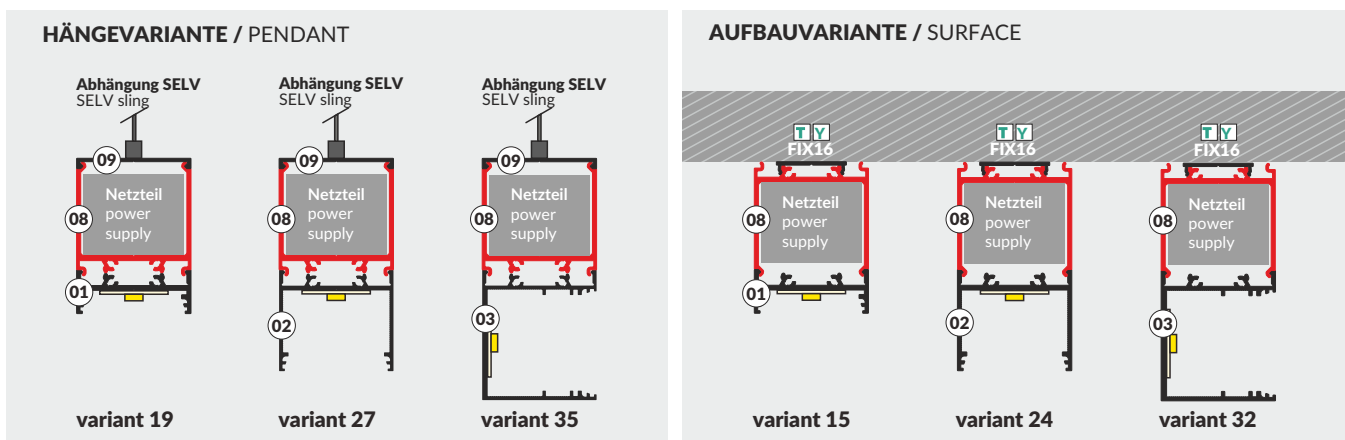

EINBAUVARIANTEN / RECESSED VARIANTS

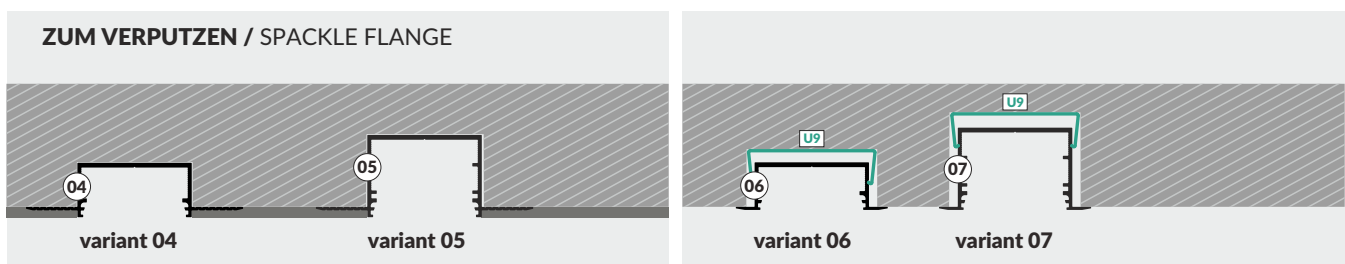

VARIO30

AUFBAUPROFILE / SURFACE

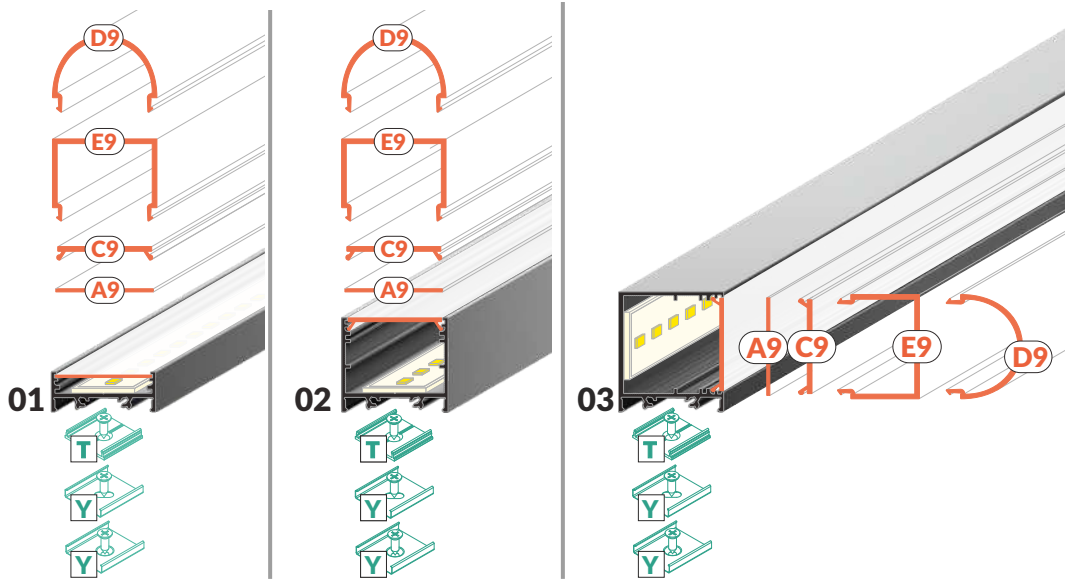

NETZTEILGEHÄUSE POWER SUPPLY COVER

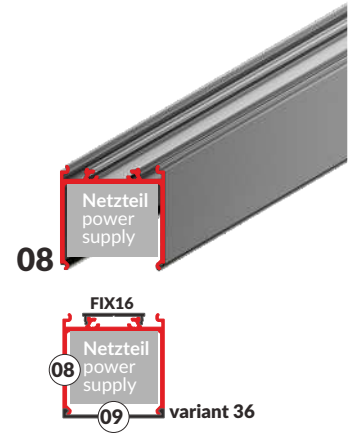

HILFSPROFILE / ASSISTANT PROFILES

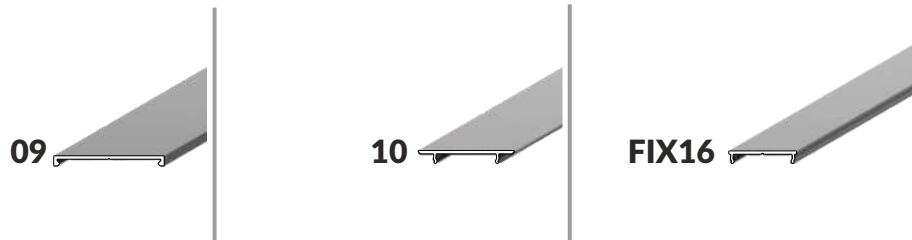

EINABUPROFILE ZUM VERPUTZEN RECESSED SPACKLE FLANGE

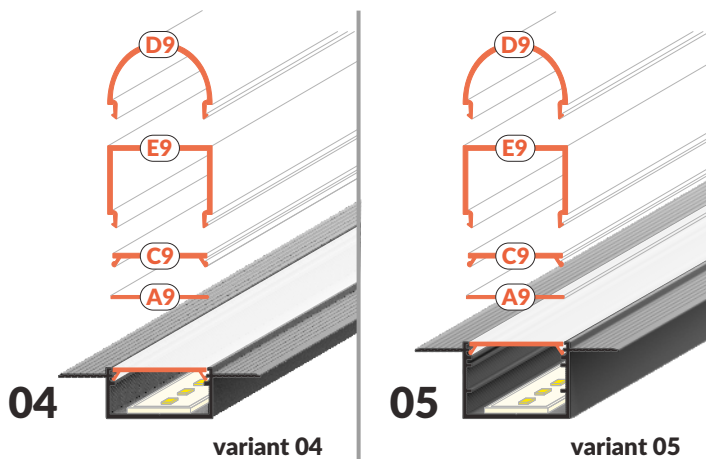

EINABUPROFILE RECESSED

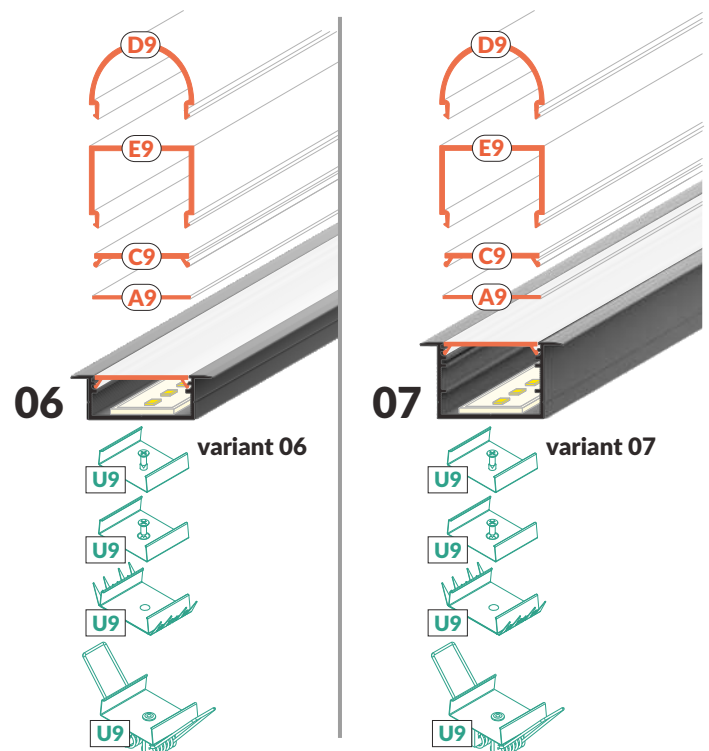

AUFBAUPROFILE SURFACE PROFILES



VARIO30-01 > 7.06
VARIO30-02 > 7.06
VARIO30-03 > 7.06
VARIO30-08 > 7.06

VARIO30-09 > 7.07
VARIO30-10 > 7.07
FIX16 > 7.07

Halter / mountings > 7.08
Endkappen / endings > 7.09
Verbindungsstücke / connectors > 7.12

Abdeckungen / diffusers > 7.18
übrige / others > 7.22

AUFBAUPROFILE, ENERGIEVERSORGUNGSGEHÄUSE

SURFACE, POWER SUPPLY COVER

Auf Lager verfügbar
Available in stock



LED Profil / LED profile VARIO30-01

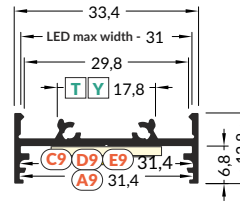
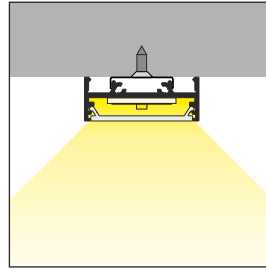

weiß	eloxiert	schwarz eloxiert	Rohaluminium
white	anodized	black anodized	raw
95V3020001	95V3020020	95V3020021	95V3020000

Artikelnummer = 1 Stück, Länge 2.000 mm
INDEX = 1 pc, length 2000 mm

LED Profil / LED profile VARIO30-02

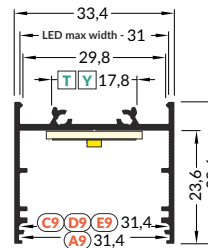
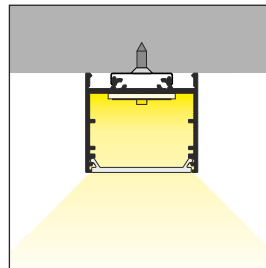

weiß	eloxiert	schwarz eloxiert	Rohaluminium
white	anodized	black anodized	raw
95V3060001	95V3060020	95V3060021	95V3060000

Artikelnummer = 1 Stück, Länge 2.000 mm
INDEX = 1 pc, length 2000 mm

LED Profil / LED profile VARIO30-03

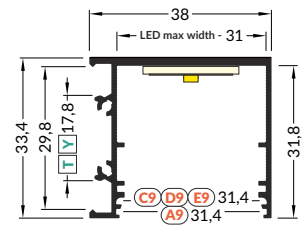
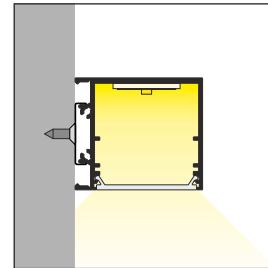
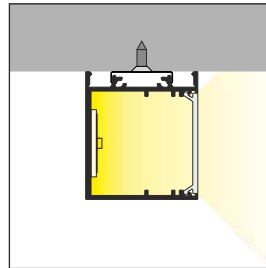

weiß	eloxiert	schwarz eloxiert	Rohaluminium
white	anodized	black anodized	raw
95V3100001	95V3100020	95V3100021	95V3100000

Artikelnummer = 1 Stück, Länge 2.000 mm
INDEX = 1 pc, length 2000 mm

Einspeisungsprofil / power supply profile VARIO30-08

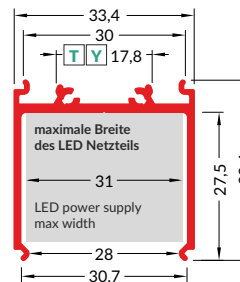
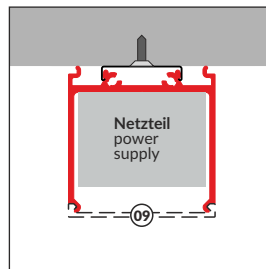

weiß	eloxiert	schwarz eloxiert	Rohaluminium
white	anodized	black anodized	raw
95V3300001	95V3300020	95V3300021	95V3300000

Artikelnummer = 1 Stück, Länge 2.000 mm
INDEX = 1 pc, length 2000 mm

Die zugänglichen Längen: 1000 mm, 2000 mm, 3000 mm, 4000 mm. Die standardmäßige Toleranz der Länge von Profilen beträgt: +20 mm. Mehr Informationen >>1.08.
Available lengths: 1000 mm, 2000 mm, 3000 mm, 4000 mm. The standard profile length tolerance is +20 mm. More details >> 1.08.



Aluminiumabdeckplatte / cover VARIO30-09

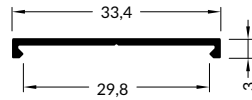

weiß	eloxiert	schwarz eloxiert	Rohaluminium
white	anodized	black anodized	raw
95V3340001	95V3340020	95V3340021	95V3340000

Artikelnummer = 1 Stück, Länge 2.000 mm
INDEX = 1 pc, length 2000 mm

Aluminiumabdeckplatte / cover VARIO30-10

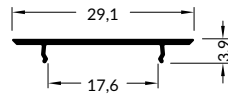

weiß	eloxiert	schwarz eloxiert	Rohaluminium
white	anodized	black anodized	raw
95V3380001	95V3380020	95V3380021	95V3380000

Artikelnummer = 1 Stück, Länge 2.000 mm
INDEX = 1 pc, length 2000 mm

LED Profile / LED profile FIX16

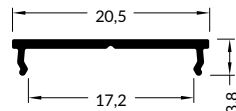

weiß	eloxiert	schwarz eloxiert	Rohaluminium
white	anodized	black anodized	raw
95C6020001	95C6020020	95C6020021	95C6020000

Artikelnummer = 1 Stück, Länge 2.000 mm
INDEX = 1 pc, length 2000 mm



Halter Y flexibel Y flexible mounting plate

Material: rostfreier Stahl
material: stainless steel

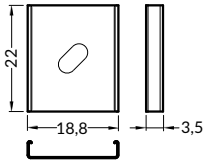

Halter Y flexibel cone cone Y flexible mounting plate

Material: rostfreier Stahl
material: stainless steel

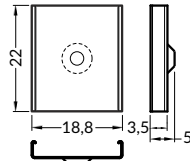

Halter T T mounting plate

Material: Aluminium
material: aluminium

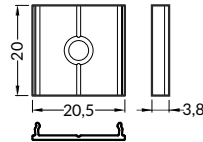

Gelenkhalter tilted bracket

Material: rostfreier Stahl, Kunststoff
material: stainless steel, plastic

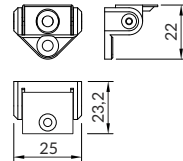

für einen Satz soll man
die flexiblen Y Halter cone
zusätzlich kaufen
please note you need
the Y mounting plate
that is not included

Halter	inox	Rohaluminium		
mountings	inox	raw aluminium		
Halter Y flexibel / Y flexible mounting plate	95A2090019	-		
Halter Y flexibel cone / cone Y flexible mounting plate	95A2130019	-		
Halter T / T mounting plate	-	C6960000		
	weiß	silbern	schwarz	grau
	white	silver	black	grey
Gelenkhalter / tilted bracket	9567230001	9567230040	9567230002	9567230022

Artikelnummer = 10 Sets = 20 Stück / INDEX = 10 sets = 20 pcs

BEZEICHNUNG DER ENDKAPPEN ENDINGS KNOW HOW

Auf Lager verfügbar
Available in stock



Abdeckung / Abdeckprofil / Profil
diffuser / cover / profile

die für das Profil 08 vorgesehene Endkappe
ending dedicated to VARIO30-08 profile

der untere Teil des LED Profils
bottom of the LED profile

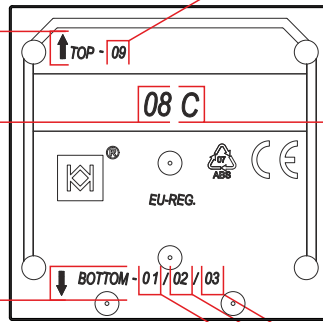

Die Name der Profile, die mit einer gewählten Endkappe zusammenpassen:
- Abdeckprofil VARIO30-09

names of profiles fitting with chosen ending:
- VARIO30-09 cover

Variantentyp
type of variant

die Namen der Profile für eine gewählte Endkappe
- LED Profil VARIO30-01
- LED Profil VARIO30-02
- LED Profil VARIO30-03

names of profiles fitting with chosen ending:
- LED profile VARIO30-01
- LED profile VARIO30-02
- LED profile VARIO30-03

Beispiel / an example
VARIANT 18

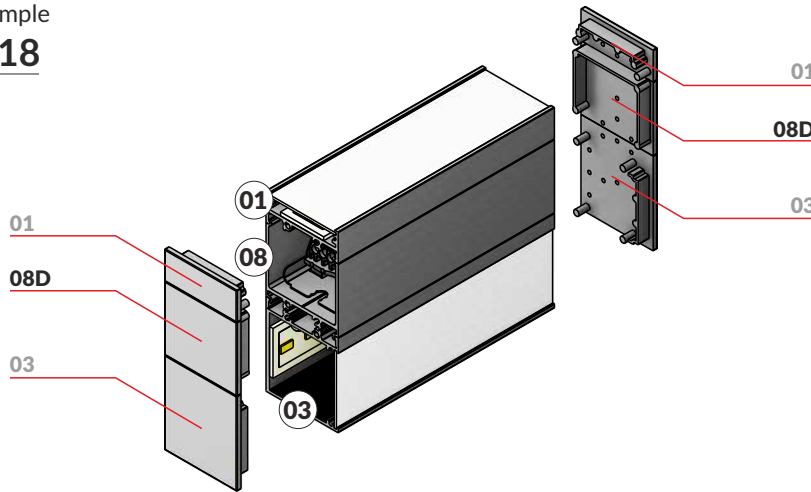

ENDKAPPEN / ENDINGS

Material: ABS

material: ABS

Endkappe VARIO30-01
VARIO30-01 ending

Endkappe VARIO30-02
VARIO30-02 ending

Endkappe VARIO30-03
VARIO30-03 ending

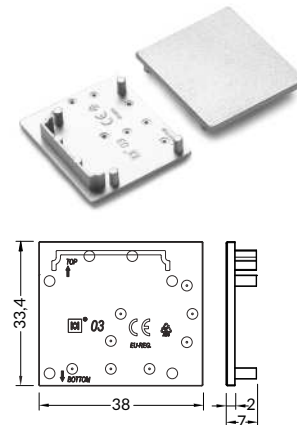
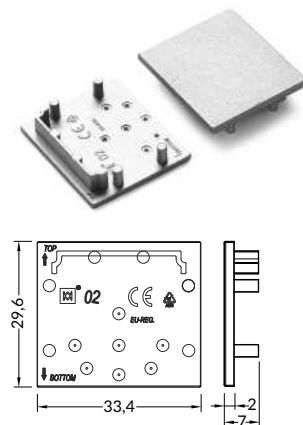
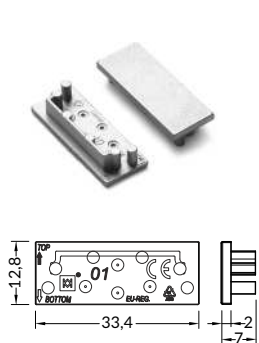

die Endkappe für die Profile
ending for profile

weiß
white

silbern
silver

schwarz
black

grau
grey

VARIO30-01

95V4870001

95V4870040

95V4870002

95V4870022

VARIO30-02

95V4880001

95V4880040

95V4880002

95V4880022

VARIO30-03

95V4890001

95V4890040

95V4890002

95V4890022

Artikelnummer = 10 Sets = 20 Stück / INDEX = 10 sets = 20 pcs,



Endkappe VARIO30-08A / VARIO30-08A ending

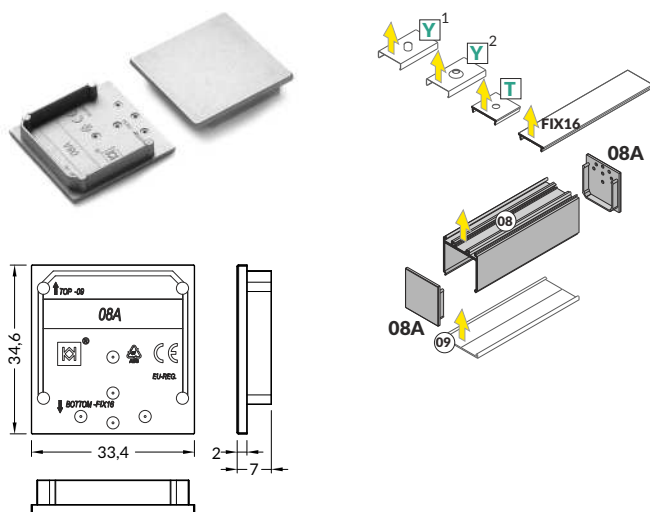

Endkappe VARIO30-08B / VARIO30-08B ending

Für Varianten: 15, 24, 32 / For variants: 15, 24, 32

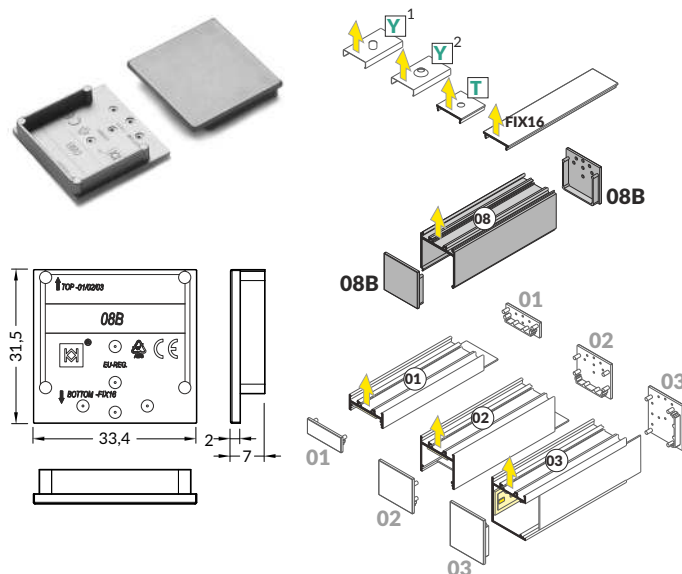

Endkappe VARIO30-08C / VARIO30-08C ending

Für Varianten: 19, 27, 35 / For variants: 19, 27, 35

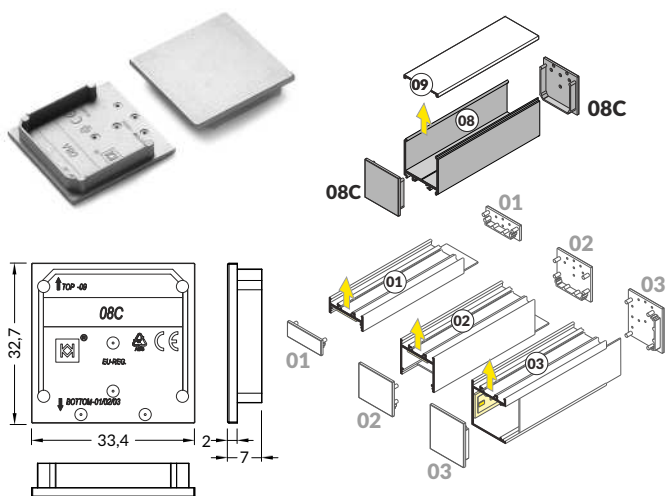

Endkappe VARIO30-08D / VARIO30-08D ending

Für Varianten: 16, 17, 18, 25, 26, 34 / For variants: 16, 17, 18, 25, 26, 34

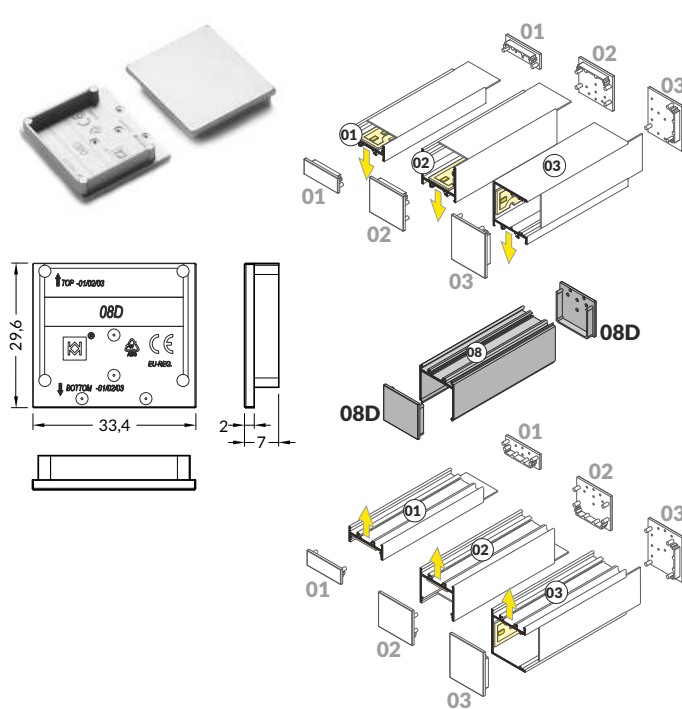

die Endkappe für die Profile
ending for profile

weiß
white

silbern
silver

schwarz
black

grau
grey

VARIO30-08ABCD

95V4600001

95V4600040

95V4600002

95V4600022

Artikelnummer = 1 Set = 2 x 08A + 2 x 08B + 2 x 08C + 2x08D / INDEX = 1 set = 2 x 08A + 2 x 08B + 2 x 08C + 2x08D

METALLENDKAPPEN / METAL ENDING

Material: Stahl

material: steel

Auf Lager verfügbar
Available in stock



Endkappe VARIO30-16-E9 aus Metall / VARIO30-16-E9 metal ending

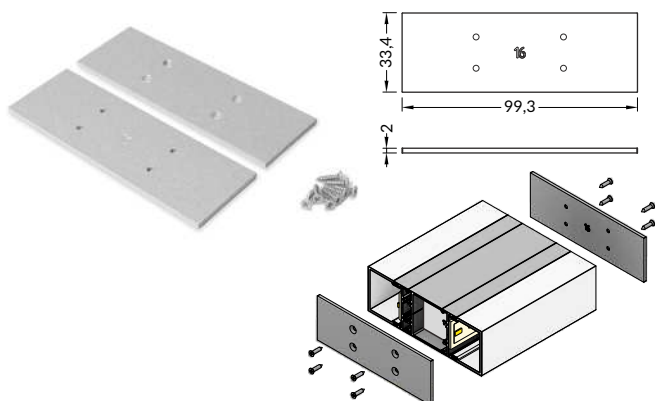

Endkappe VARIO30-19-E9 aus Metall / VARIO30-19-E9 metal ending

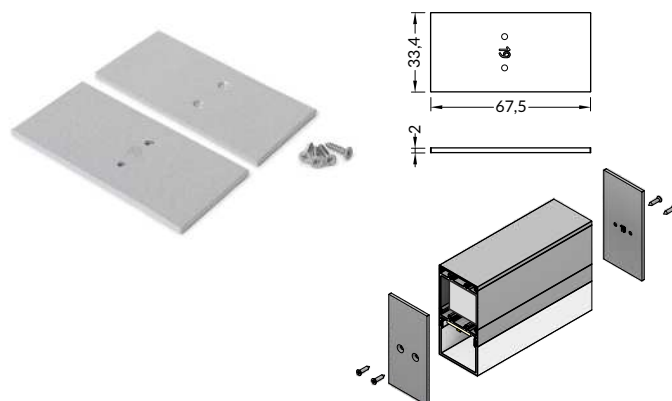

Endkappe VARIO30-27 aus Metall / VARIO30-27 metal ending

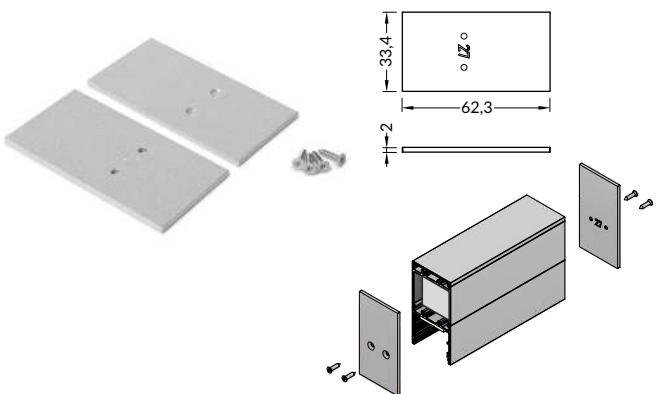

Endkappe VARIO30-32 aus Metall / VARIO30-32 metal ending

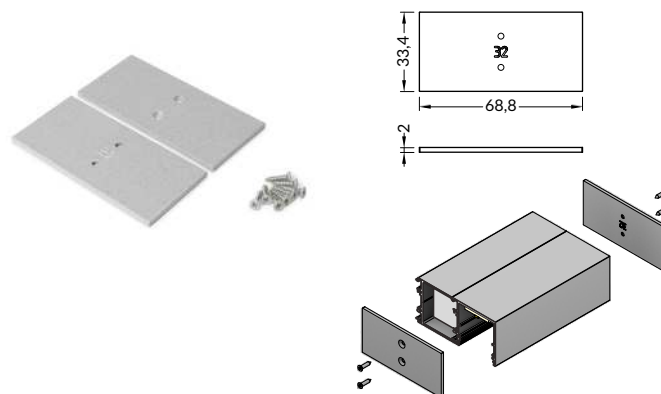

Endkappe VARIO30-34 aus Metall / VARIO30-34 metal ending

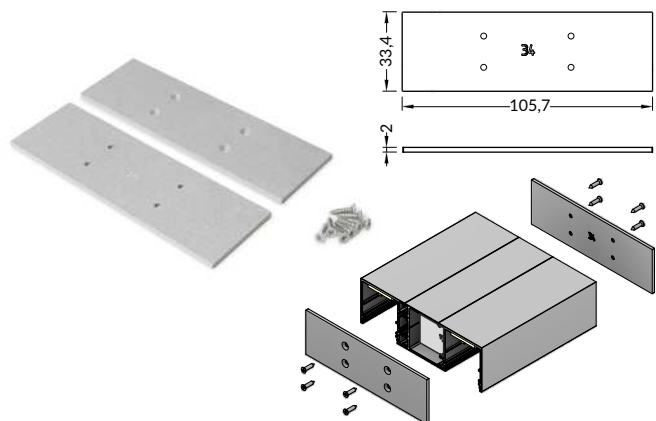

die Endkappe für die Variante

weiß

silbern

schwarz

ending for variant

white

silver

black

VARIO30-16

95V4550001s

95V4550022s

95V4550002s

VARIO30-19

95V4560001s

95V4560022s

95V4560002s

VARIO30-27

95V4570001s

95V4570022s

95V4570002s

VARIO30-32

95V4580001s

95V4580022s

95V4580002s

VARIO30-34

95V4590001s

95V4590022s

95V4590002s

Artikelnummer = 1 Set = 20 Stück / INDEX = 1 set = 2 pcs.

für die Profile / for profiles

VARIO30-02

60 Grad / deg

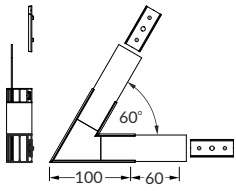

90 Grad / deg

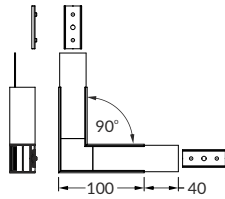

90 Grad gebogen / deg bent

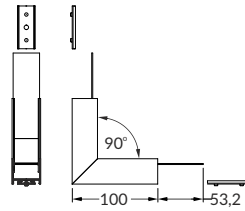

120 Grad / deg

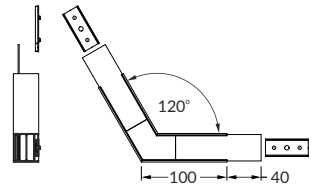

135 Grad / deg

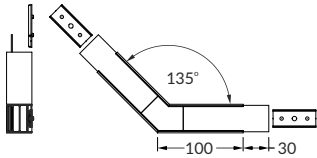

180 Grad / deg

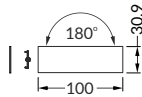

270 Grad gebogen / deg bent

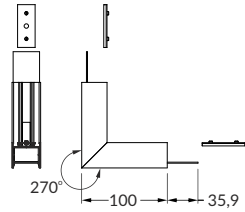

weiß eloxiert schwarz eloxiert

white anodized black anodized

Verbinder 60 Grad für VARIO30-02 / VARIO30-02 connector 60 deg	95V4660001s	95V4660020s	95V4660021s
Verbinder 90 Grad für VARIO30-02 / VARIO30-02 connector 90 deg	95V4670001s	95V4670020s	95V4670021s
Verbinder 90 Grad für VARIO30-02 gebogen / VARIO30-02 connector 90 deg bent	95V4680001s	95V4680020s	95V4680021s
Verbinder 120 Grad für VARIO30-02 / VARIO30-02 connector 120 deg	95V4690001s	95V4690020s	95V4690021s
Verbinder 135 Grad für VARIO30-02 / VARIO30-02 connector 135 deg	95V4700001s	95V4700020s	95V4700021s
Verbinder 180 Grad für VARIO30-0203 / VARIO30-0203 connector 180 deg	-	-	-
Verbinder 270 Grad für VARIO30-02 gebogen / VARIO30-02 connector 270 deg bent	95V4710001s	95V4710020s	95V4710021s

Artikelnummer = 1 Set / INDEX = 1 set

für die Profile / for profiles

VARIO30-03

180 Grad / deg

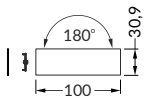

weiß eloxiert schwarz eloxiert

white anodized black anodized

Verbinder 180 Grad für VARIO30-0203 / VARIO30-0203 connector 180 deg	-	-	-	95V4640000s
--	---	---	---	--------------------

Artikelnummer = 1 Set / INDEX = 1 set

EINBAUPROFILE RECESSED PROFILES

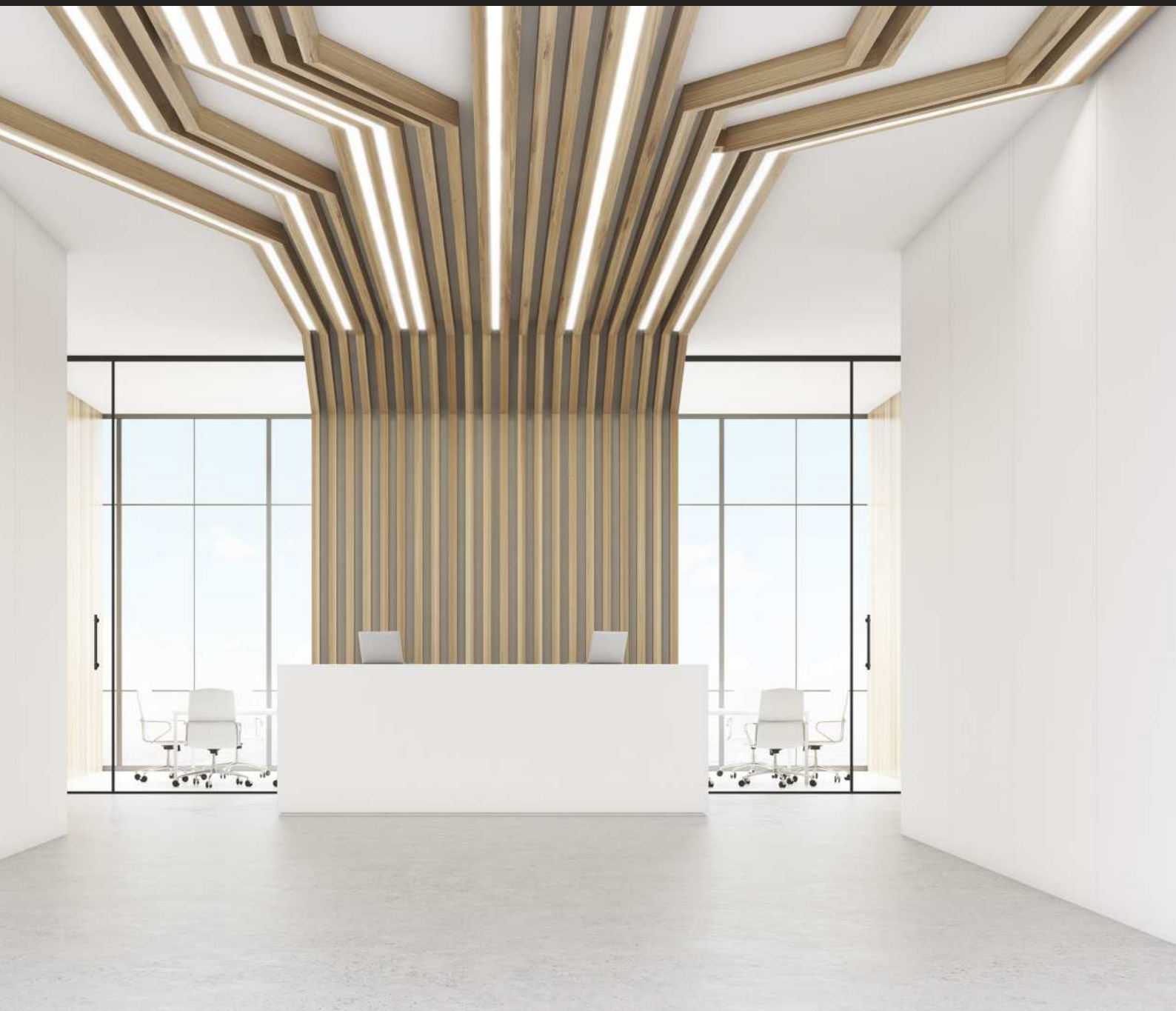

VARIO30-04 > 7.14
VARIO30-05 > 7.14
VARIO30-06 > 7.14
VARIO30-07 > 7.14

Halter / mountings > 7.15
Endkappen / endings > 7.15
Verbindungsstücke / connectors > 7.16

Abdeckungen / diffusers > 7.18
übrige / others > 7.22



LED Profil / LED profile VARIO30-04

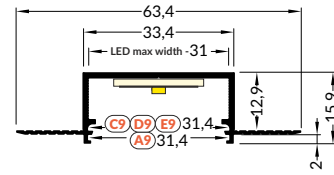
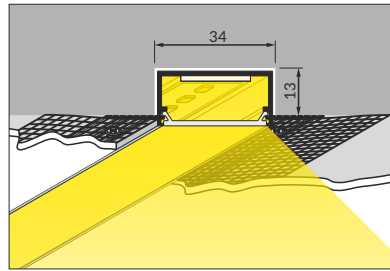

weiß	eloxiert	schwarz eloxiert	Rohaluminium
white	anodized	black anodized	raw
95V3140001	95V3140020	-	95V3140000

Artikelnummer = 1 Stück, Länge 2.000 mm
INDEX = 1 pc, length 2000 mm

LED Profil / LED profile VARIO30-05

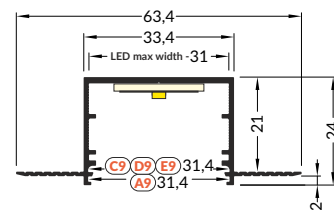
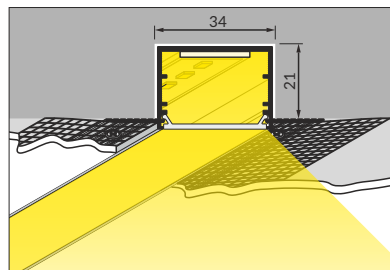

weiß	eloxiert	schwarz eloxiert	Rohaluminium
white	anodized	black anodized	raw
95V3180001	95V3180020	-	95V3180000

Artikelnummer = 1 Stück, Länge 2.000 mm
INDEX = 1 pc, length 2000 mm

LED Profil / LED profile VARIO30-06

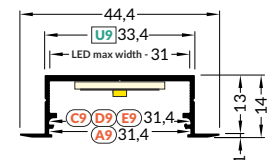
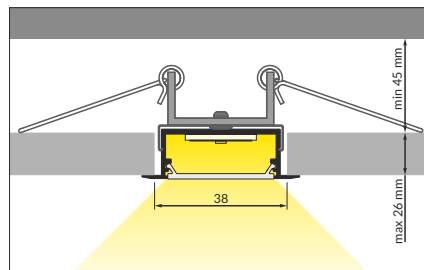
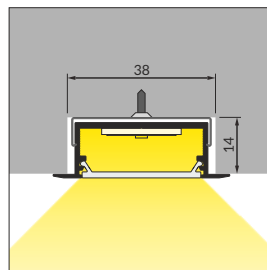

weiß	eloxiert	schwarz eloxiert	Rohaluminium
white	anodized	black anodized	raw
95V3220001	95V3220020	95V3220021	95V3220000

Artikelnummer = 1 Stück, Länge 2.000 mm
INDEX = 1 pc, length 2000 mm

LED Profil / LED profile VARIO30-07

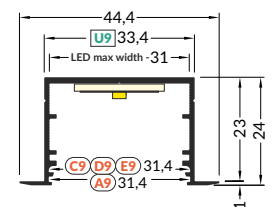
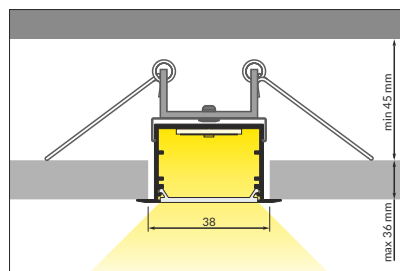
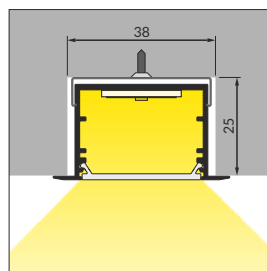

weiß	eloxiert	schwarz eloxiert	Rohaluminium
white	anodized	black anodized	raw
95V3260001	95V3260020	95V3260021	95V3260000

Artikelnummer = 1 Stück, Länge 2.000 mm
INDEX = 1 pc, length 2000 mm

Die zugänglichen Längen: 1000 mm, 2000 mm, 3000 mm, 4000 mm. Die standardmäßige Toleranz der Länge von Profilen beträgt: +20 mm. Mehr Informationen >> 1.08.
Available lengths: 1000 mm, 2000 mm, 3000 mm, 4000 mm. The standard profile length tolerance is +20 mm. More details >> 1.08.



HALTER / MOUNTINGS

Halter U9 U9 mounting plate

Material: rostfreier Stahl
material: stainless steel

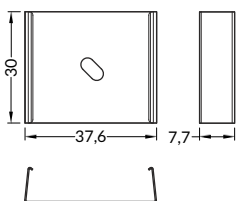

Halter U9 cone cone U9 mounting plate

Material: rostfreier Stahl
material: stainless steel

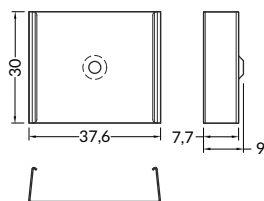

Halter U9 rack rack U9 mounting plate

Material: rostfreier Stahl
material: stainless steel

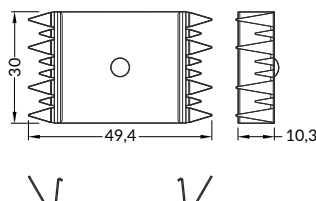

Halter U9 Feder spring U9 mounting plate

Material: rostfreier Stahl, Aluminium
material: stainless steel, aluminium

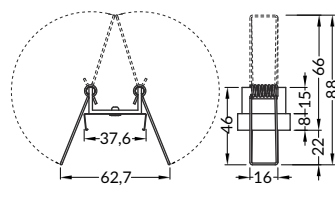

Halter

mountings

inox

inox

Halter U9 / U9 mounting plate

95V4840019

Halter U9 cone / cone U9 mounting plate

95V4850019

Artikelnummer = 10 Sets = 20 Stück / INDEX = 10 sets = 20 pcs,

Halter U9 rack / rack U9 mounting plate

95V4860019

Halter U9 Feder / spring U9 mounting plate

95V4620019s

Artikelnummer = 1 Set = 2 Stück / INDEX = 1 set = 2 pcs.

ENDKAPPEN / ENDINGS

Material: ABS

material: ABS

Endkappe VARIO30-04 VARIO30-04 ending

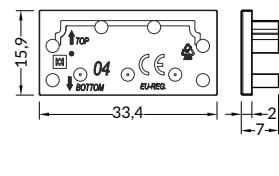

Endkappe VARIO30-05 VARIO30-05 ending

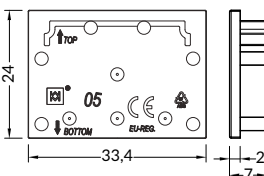
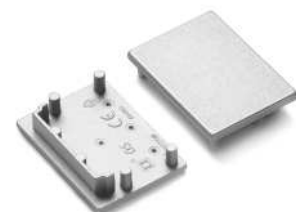

Endkappe VARIO30-06 VARIO30-06 ending

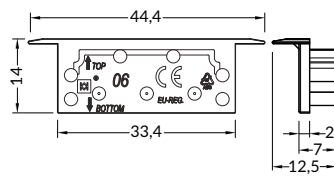

Endkappe VARIO30-07 VARIO30-07 ending

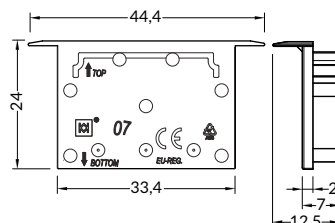

die Endkappe für das Profil

ending for profile

weiß

white

silbern

silver

schwarz

black

grau

grey

VARIO30-04

95V4900001

95V4900040

-

95V4900022

VARIO30-05

95V4910001

95V4910040

-

95V4910022

VARIO30-06

95V4920001

95V4920040

95V4920040

95V4920022

VARIO30-07

95V4930001

95V4930040

95V4930002

95V4930022

Artikelnummer = 10 Sets = 20 Stück / INDEX = 10 sets = 20 pcs.

für die Profile / for profiles

VARIO30-05

60 Grad / deg

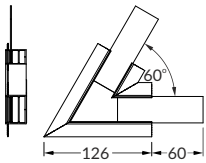

135 Grad / deg

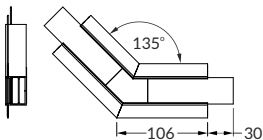

90 Grad / deg

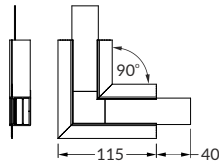

180 Grad / deg

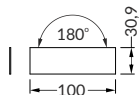

90 Grad gebogen / deg bent

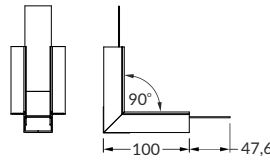

270 Grad gebogen / deg bent

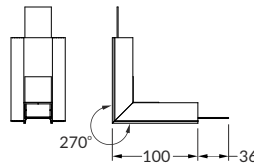

120 Grad / deg

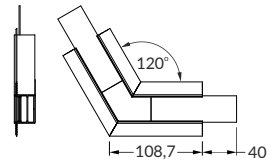

Verbinder 60 Grad für VARIO30-05 / VARIO30-05 connector 60 deg	95V4720001s	95V4720020s	-
Verbinder 90 Grad für VARIO30-05 / VARIO30-05 connector 90 deg	95V4730001s	95V4730020s	-
Verbinder 90 Grad für VARIO30-05 gebogen VARIO30-05 connector 90 deg bent	95V4740001s	95V4740020s	-
Verbinder 120 Grad für VARIO30-05 / VARIO30-05 connector 120 deg	95V4750001s	95V4750020s	-
Verbinder 135 Grad für VARIO30-05 / VARIO30-05 connector 135 deg	95V4760001s	95V4760020s	-
Verbinder 180 Grad für VARIO30-05 / VARIO30-05 connector 180 deg	-	-	95V4650000s
Verbinder 270 Grad für VARIO30-05 gebogen VARIO30-05 connector 270 deg bent	95V4770001s	95V4770020s	-

weiß	eloxiert	schwarz eloxiert
white	anodized	black anodized

Artikelnummer = 1 Set / INDEX = 1 set

für die Profile / for profiles

VARIO30-07

60 Grad / deg

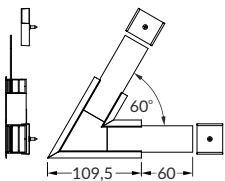

135 Grad / deg

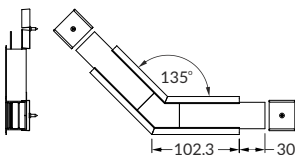

90 Grad / deg

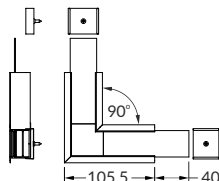

180 Grad / deg

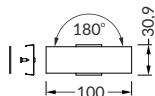

90 deg bent / deg bent

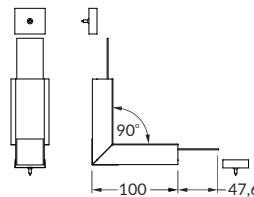

270 deg bent / deg bent

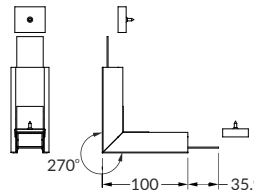

120 Grad / deg

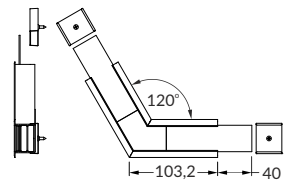

Verbinder 60 Grad für VARIO30-07 / VARIO30-07 connector 60 deg	95V4780001s	95V4780020s	95V4780021s
Verbinder 90 Grad für VARIO30-07 / VARIO30-07 connector 90 deg	95V4790001s	95V4790020s	95V4790021s
Verbinder 90 Grad für VARIO30-07 gebogen VARIO30-07 connector 90 deg bent	95V4800001s	95V4800020s	95V4800021s
Verbinder 120 Grad für VARIO30-07 / VARIO30-07 connector 120 deg	95V4810001s	95V4810020s	95V4810021s
Verbinder 135 Grad für VARIO30-07 / VARIO30-07 connector 135 deg	95V4820001s	95V4820020s	95V4820021s
Verbinder 180 Grad für VARIO30-07 / VARIO30-07 connector 180 deg	-	-	95V4610000s
Verbinder 270 Grad für VARIO30-07 gebogen VARIO30-07 connector 270 deg bent	95V4830001s	95V4830020s	95V4830021s

weiß	eloxiert	schwarz eloxiert
white	anodized	black anodized

Artikelnummer = 1 Set / INDEX = 1 set

KOMPATIBLES ZUBEHÖR SYSTEM ACCESSORIES

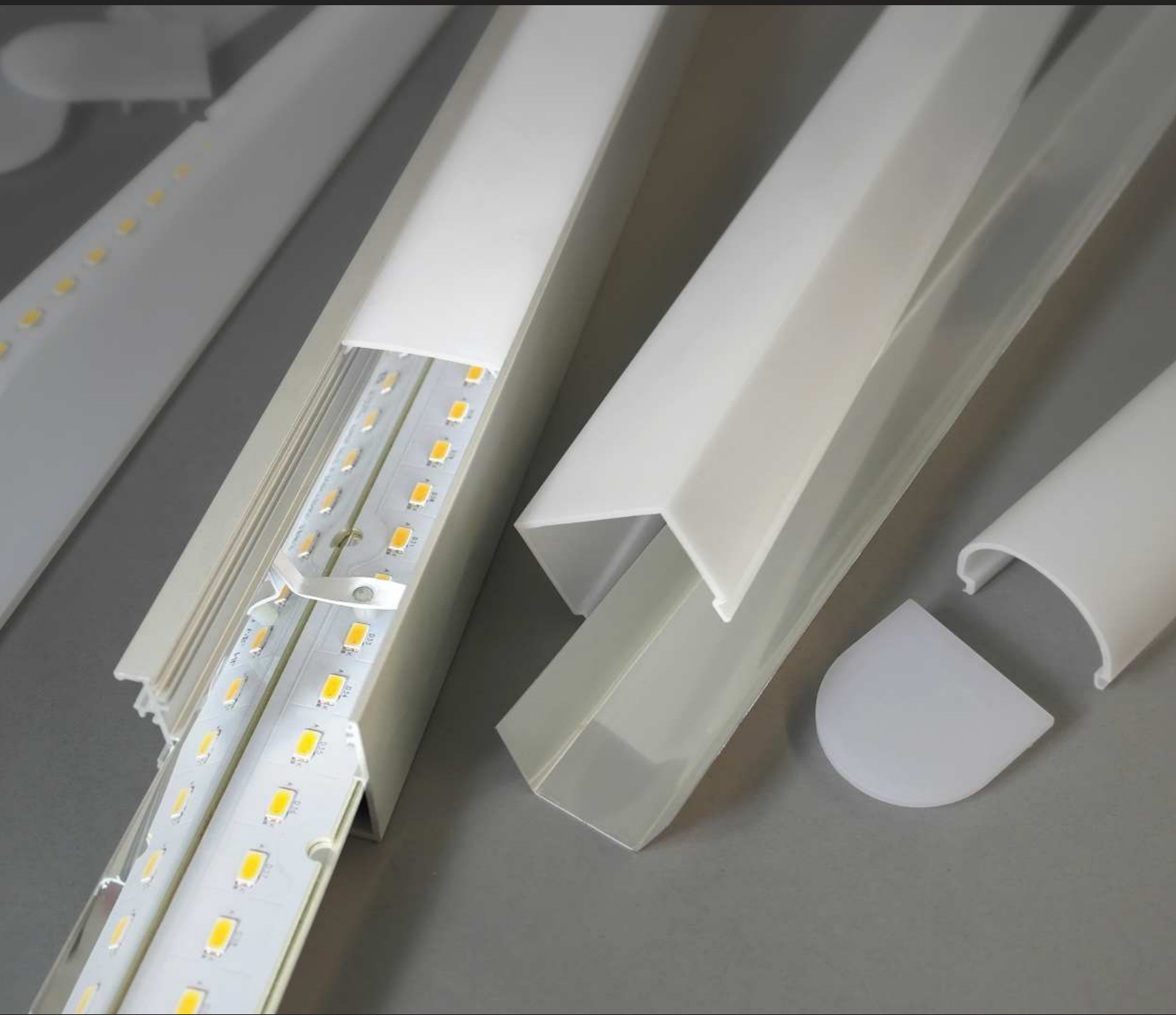

Abdeckungen / diffusers > 7.18
übrige / others > 7.22



Abdeckung A9 einziehbar / A9 slide diffuser

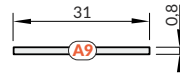
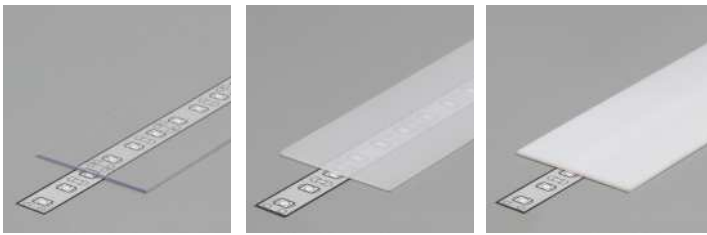

transparent
Material: PC
transparent
material: PC

satiniert
Material: PP
frosted
material: PP

opal
Material: PP
opal
material: PP



Achtung! Die Abmessungen des Platzes für die Montage von LED Lichtquelle / Note! Dimensions of the space to install LED source

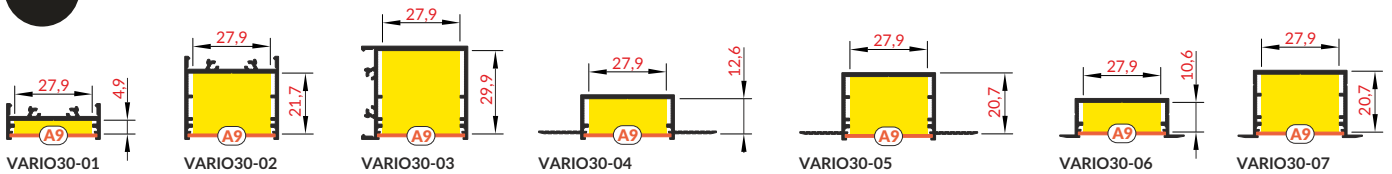

	transparent	satiniert	opal
Abdeckung A9 einziehbar / A9 slide diffuser	95V3420016	95V3420039	95V3420038

Artikelnummer = 10 Stück, Länge 2.000 mm / INDEX = 10 pcs, length 2000 mm

Abdeckung C9 einclipsbar / C9 click diffuser

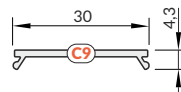

transparent
Material: PMMA
transparent
material: PMMA

opal
Material: PMMA
opal
material: PMMA



Achtung! Die Abmessungen des Platzes für die Montage von LED Lichtquelle / Note! Dimensions of the space to install LED source

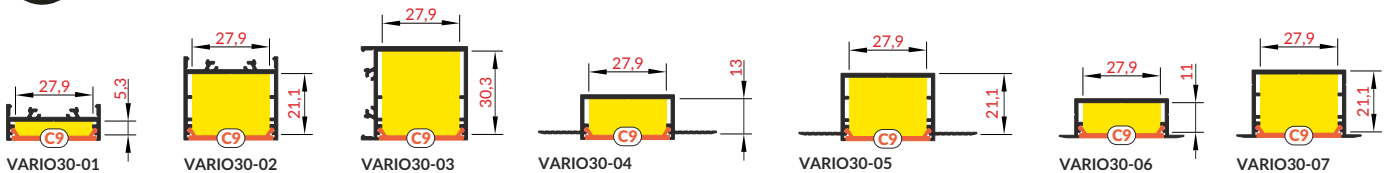

	transparent	satiniert	opal
Abdeckung C9 einclipsbar / C9 click diffuser	95V3460016	-	95V3460038

Artikelnummer = 1 Stück, Länge 2.000 mm / INDEX = 1 pc, length 2000 mm



Abdeckung D9 einclipsbar / D9 click diffuser

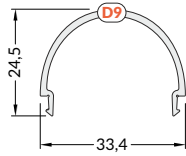

opal
Material: PMMA
opal
material: PMMA



Achtung! Die Abmessungen des Platzes für die Montage von LED Lichtquelle / **Note!** Dimensions of the space to install LED source

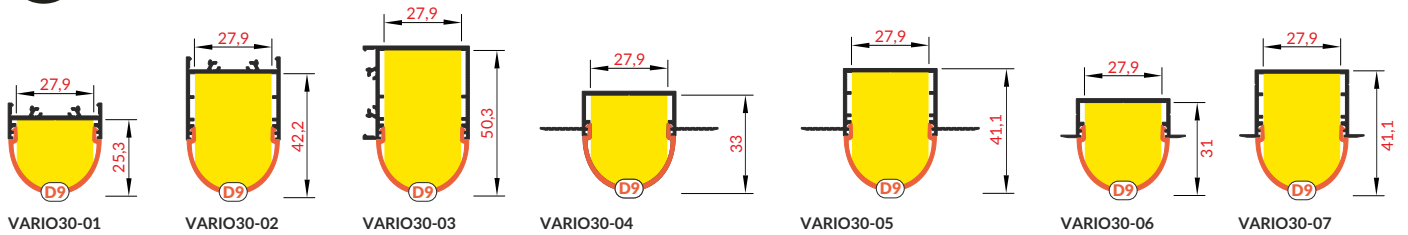

	transparent	satiniert	opal
	transparent	frosted	opal
Abdeckung D9 einclipsbar / D9 click diffuser	-	-	95V3500038

Artikelnummer = 1 Stück, Länge 2.000 mm / INDEX = 1 pc, length 2000 mm

Die Toleranz der Länge von Abdeckungen beträgt: +20 mm. Mehr Informationen >> 1.08.
The standard cover length tolerance is +20 mm. More details >> 1.08.

DIE ENDKAPPE FÜR DIE ABDECKUNG D9 / ENDINGS FOR D9 DIFFUSER

Material: PMMA

material: PMMA

Endkappe D9 D9 ending

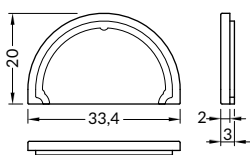
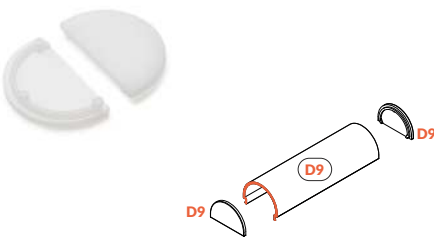

Endkappe VARIO30-01-D9 VARIO30-01-D9 ending

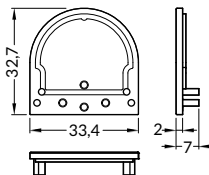
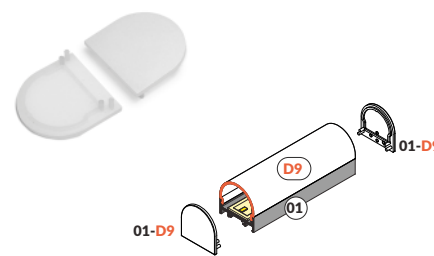

Endkappe VARIO30-02-D9 VARIO30-02-D9 ending

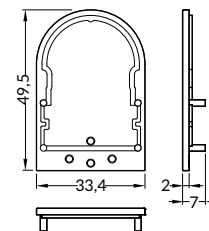
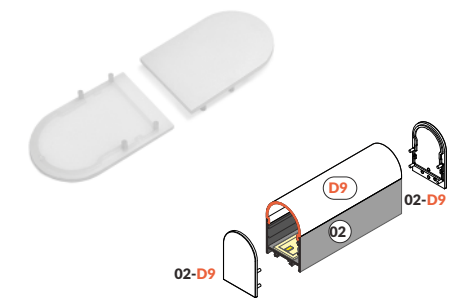

opal

opal

Endkappe D9 / D9 ending	95V4980038
Endkappe VARIO30-01-D9 / VARIO30-01-D9 ending	95V4500038
Endkappe VARIO30-02-D9 / VARIO30-02-D9 ending	95V4540038

Artikelnummer = 10 Sets = 20 Stück / INDEX = 10 sets = 20 pcs,



Abdeckung E9 einclipsbar / E9 click diffuser

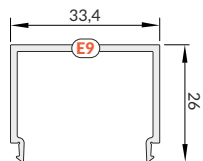

opal
Material: PMMA
opal
material: PMMA



Achtung! Die Abmessungen des Platzes für die Montage von LED Lichtquelle / Note! Dimensions of the space to install LED source

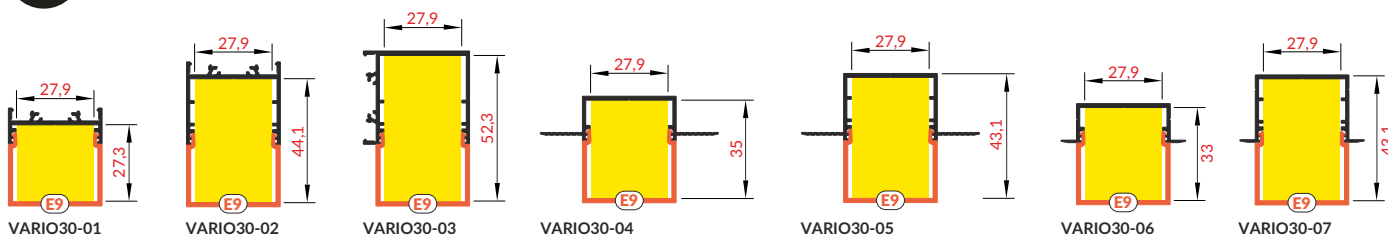

	transparent	satiniert	opal
Abdeckung E9 einclipsbar / E9 click diffuser	-	-	95V3540038

Artikelnummer = 1 Stück, Länge 2.000 mm / INDEX = 1 pc, length 2000 mm
Die Toleranz der Länge von Abdeckungen beträgt: +20 mm. Mehr Informationen >> 1.08.
The standard cover length tolerance is +20 mm. More details >> 1.08.

DIE ENDKAPPE FÜR DIE ABDECKUNG E9 / ENDINGS FOR E9 DIFFUSER

Material: PMMA

material: PMMA

Endkappe E9 E9 ending

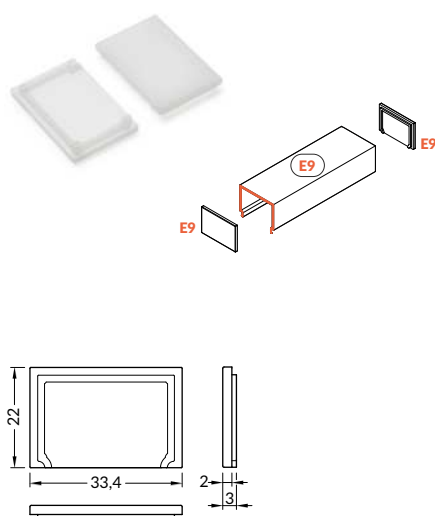

Endkappe VARIO30-01-E9 VARIO30-01-E9 ending

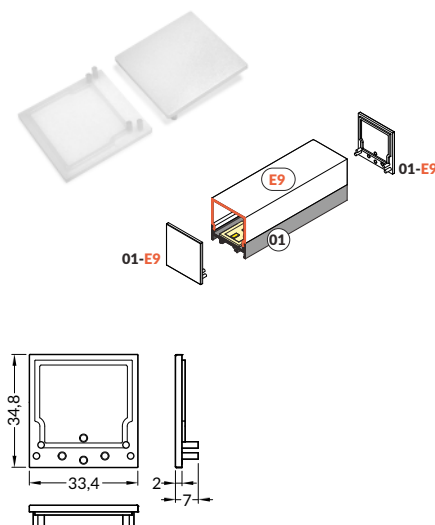

Endkappe VARIO30-02-E9 VARIO30-02-E9 ending

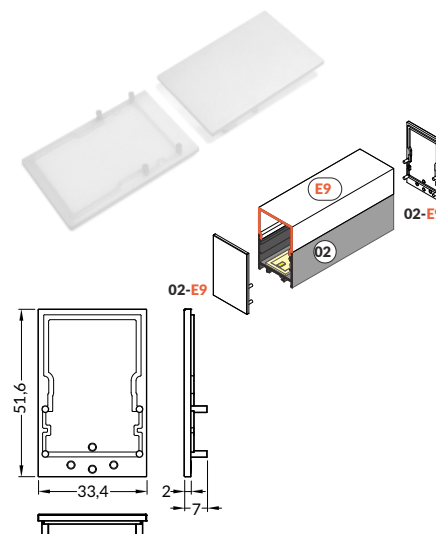

Endkappe E9 / E9 ending	95V4990038
Endkappe VARIO30-01-E9 / VARIO30-01-E9 ending	95V4510038
Endkappe VARIO30-02-E9 / VARIO30-02-E9 ending	95V4550038

Artikelnummer = 10 Sets = 20 Stück / INDEX = 10 sets = 20 pcs,

LEUCHTEFFEKT LIGHTING EFFECT

Reflektor VARIO30 + LED Klemme VARIO30-1
VARIO30 reflector + VARIO30-1 LED clamp



empfohlen für die Profile:
Recommended for profiles:
02, 03 > 7.06
05, 07 > 7.14
und Abdeckungen: / and diffusers:
A9, C9, D9, E9 > 7.18

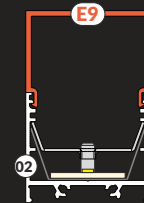
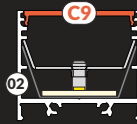

LED Montageteil für VARIO30 + LED Klemme VARIO30
VARIO30 LED mounting + VARIO30 LED clamp

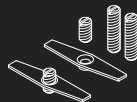

empfohlen für die Profile:
Recommended for profiles:
02, 03 > 7.06
05, 07 > 7.14
und Abdeckungen: / and diffusers:
A9, C9, D9, E9 > 7.18

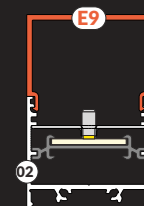
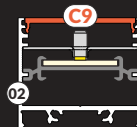

Klemme für LEDs für VARIO30-1
VARIO30-1 LED clamp



empfohlen für die Profile:
Recommended for profiles:
02, 03 > 7.06
05, 07 > 7.14
und Abdeckungen: / and diffusers:
A9, C9, D9, E9 > 7.18

Klemme für LEDs für VARIO30
VARIO30 LED clamp



empfohlen für die Profile:
Recommended for profiles:
04, 06 > 7.14
und Abdeckungen: / and diffusers:
A9, C9, D9, E9 > 7.18



LED Klemme VARIO30 VARIO30 LED clamp

Material: Stahl, Kunststoff
material: steel, plastic

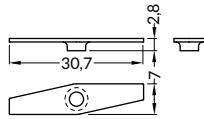

LED Klemme VARIO30-1 VARIO30-1 LED clamp

Material: Stahl, Kunststoff
material: steel, plastic

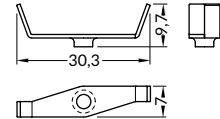

weiß lackiert

white painted

LED Klemme VARIO30 / VARIO30 LED clamp

95V4630001

LED Klemme VARIO30-1 / VARIO30-1 LED clamp

95V4520001

Artikelnummer = 10 Sets = 20 Stück / INDEX = 10 sets = 20 pcs

Reflektor VARIO30 VARIO30 reflector

Material: Aluminium
material: aluminium

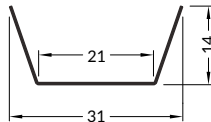

Reflektor VARIO30 / VARIO30 reflector

95V3620000

Artikelnummer = 1 Stück, Länge 2.000 mm
INDEX = 1 pc, length 2000 mm

Montageteil LED für VARIO30 VARIO30 LED mounting

Material: Aluminium
material: aluminium

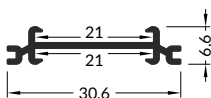

LED Montageteil für VARIO30 / VARIO30 LED mounting

Rohaluminium

raw aluminium

95V3580000

Artikelnummer = 1 Stück, Länge 2.000 mm
INDEX = 1 pc, length 2000 mm

Die zugänglichen Längen: 1000 mm, 2000 mm, 3000 mm, 4000 mm.
Die standardmäßige Toleranz der Länge von Profilen beträgt: +20 mm. Mehr Informationen >> 1.08.
Available lengths: 1000 mm, 2000 mm, 3000 mm, 4000 mm.
The standard profile length tolerance is +20 mm. More details >> 1.08.

GROßE PROFILE / BIG PROFILES



PHIL53

Profil PHIL53 / PHIL53 profile

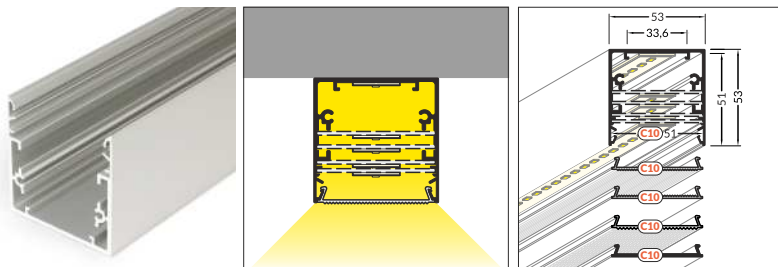

weiß lackiert	eloxiert	schwarz lackiert	Rohaluminium
---------------	----------	------------------	--------------

white painted	anodized	black painted	raw
---------------	----------	---------------	-----

9563530001	9563530020	9563530002	9563530000
-------------------	-------------------	-------------------	-------------------

Artikelnummer = 1 Stück, Länge 2.000 mm
INDEX = 1 pc, length 2000 mm

Die zugänglichen Längen: 1000 mm, 2000 mm, 3000 mm, 4000 mm.
Die standardmäßige Toleranz der Länge von Profilen beträgt: +20 mm.
Mehr Informationen >> 1.08.

Available lengths: 1000 mm, 2000 mm, 3000 mm, 4000 mm. The standard profile length tolerance is +20 mm. More details >> 1.08.

Endkappe PHIL53 / PHIL53 ending

Material: ABS / material: ABS

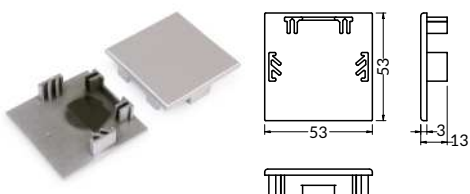

weiß	silbern	schwarz	grau
------	---------	---------	------

white	silver	black	grey
-------	--------	-------	------

9563640001	9563640040	9563640002	9563640022
-------------------	-------------------	-------------------	-------------------

Artikelnummer = 1 Set = 2 Stück
INDEX = 1 set = 2 pcs.



PHIL EINBAU / PHIL RECESSED

Profil PHIL EINBAU / PHIL RECESSED profile

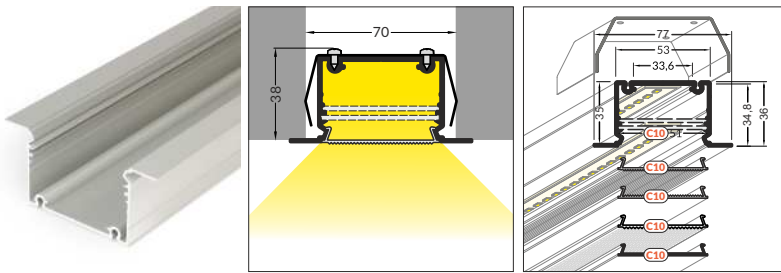

Endkappe für PHIL EINBAU / PHIL RECESSED ending
Material: ABS / material: ABS

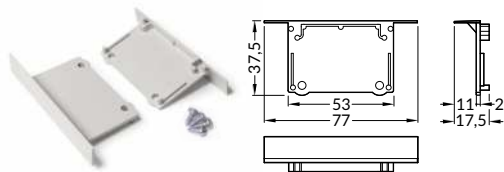

Endkappe für PHIL EINBAU aus Metal / PHIL RECESSED metal ending
Material: Stahl / material: steel

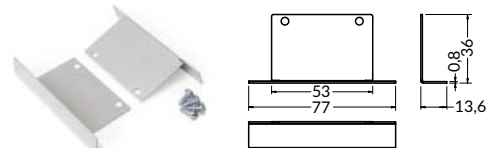

Halter für PHIL EINBAU / PHIL RECESSED holder
Material: rostfreier Stahl / material: stainless steel

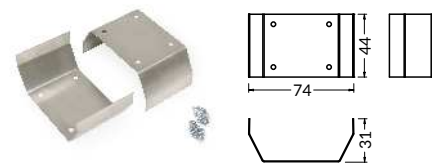

weiß lackiert	eloxiert	schwarz lackiert	Rohalu- minium
white painted	anodized	black painted	raw
9597100001	9597100020	9597100002	9597100000

Artikelnummer = 1 Stück, Länge 2.000 mm
INDEX = 1 pc, length 2000 mm

Die zugänglichen Längen: 1000 mm, 2000 mm, 3000 mm, 4000 mm.
Die standardmäßige Toleranz der Länge von Profilen beträgt: +20 mm.
Mehr Informationen >> 1.08.
Available lengths: 1000 mm, 2000 mm, 3000 mm, 4000 mm. The standard profile length tolerance is +20 mm. More details >> 1.08.

weiß	silbern	schwarz	grau
white	silver	black	grey
9597990001S	9597990040S	9597990002S	9597990022S

Artikelnummer = 1 Set = 2 Stück
INDEX = 1 set = 2 pcs,

weiß	silbern	schwarz
white	silver	black
9597120001	9597120022	9597120002

Artikelnummer = 1 Set = 2 Stück
INDEX = 1 set = 2 pcs,

inox
inox
9597510019

Artikelnummer = 1 Set = 2 Stück
INDEX = 1 set = 2 pcs,

LOWI

Profil LOWI / LOWI profile

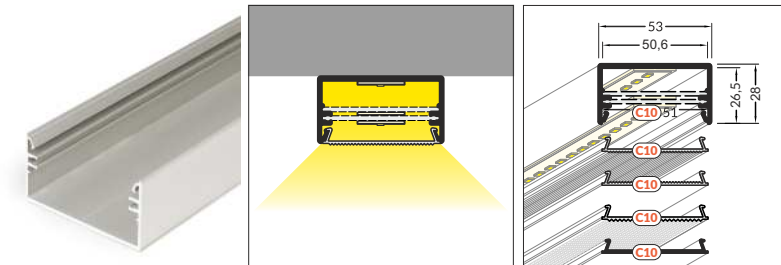

Endkappe für LOWI / LOWI ending
Material: ABS / material: ABS

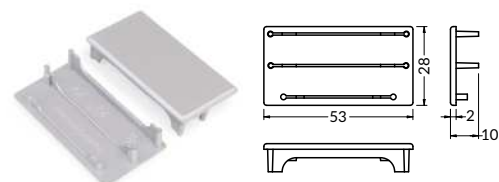

weiß lackiert	eloxiert	schwarz lackiert	Rohaluminium
white painted	anodized	black painted	raw
9593030001	9593030020	9593030002	9593030000

Artikelnummer = 1 Stück, Länge 2.000 mm
INDEX = 1 pc, length 2000 mm

Die zugänglichen Längen: 1000 mm, 2000 mm, 3000 mm, 4000 mm.
Die standardmäßige Toleranz der Länge von Profilen beträgt: +20 mm.
Mehr Informationen >> 1.08.
Available lengths: 1000 mm, 2000 mm, 3000 mm, 4000 mm. The standard profile length tolerance is +20 mm. More details >> 1.08.

weiß	silbern	schwarz	grau
white	silver	black	grey
9593066001	9593070040	9593070002	9593070022

Artikelnummer = 1 Set = 2 Stück
INDEX = 1 set = 2 pcs,



Abdeckung C10 / C10 cover

Abdeckung C10 NARROW
Material: Polycarbonat
C10 NARROW cover
material: polycarbonate

Abdeckung C10 WIDE
Material: Polycarbonat
C10 WIDE cover
material: polycarbonate

Abdeckung C10 OPAL
Material: PMMA
C10 OPAL cover
material: PMMA

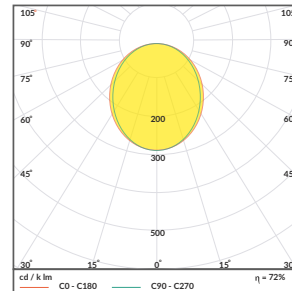
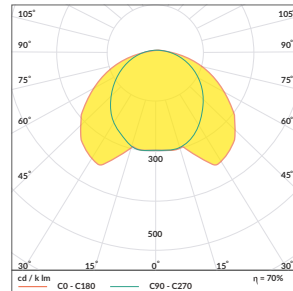
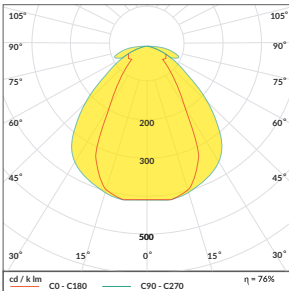
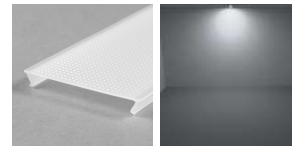
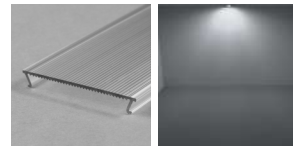
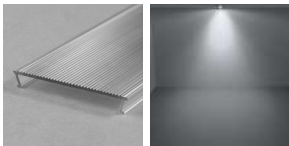
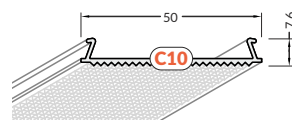
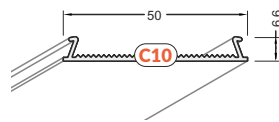
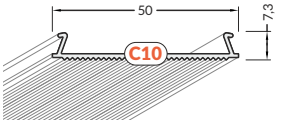

Der Vergleich von Lichtverteilungskurven bei der Anwendung von unterschiedlichen C10 Abdeckungen
Comparison of variations in the light curves measured on different C10 covers

NARROW	WIDE	OPAL
9563620000	9563590000	9563690038

Artikelnummer = 1 Stück, Länge 2.000 mm,
INDEX = 1 pc, length 2000 mm,

Die Toleranz der Länge von Abdeckungen beträgt: +20 mm.
Mehr Informationen >> 1.08.
The standard cover length tolerance is +20 mm.
More details >> 1.08.

Aluminiumabdeckplatte C10 / C10 aluminium cover

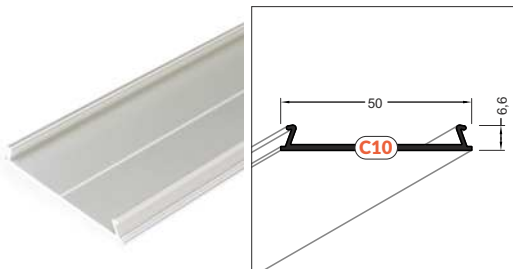

weiß lackiert	eloxiert	schwarz laktiert	Rohaluminium
white painted	anodized	black painted	raw
9563560001	9563560020	9563560002	9563560000

Artikelnummer = 1 Stück, Länge 2.000 mm
INDEX = 1 pc, length 2000 mm

Die zugänglichen Längen: 1000 mm, 2000 mm, 3000 mm, 4000 mm. Die standardmäßige
Toleranz der Länge von Profilen beträgt: +20 mm. Mehr Informationen >> 1.08.
Available lengths: 1000 mm, 2000 mm, 3000 mm, 4000 mm.
The standard profile length tolerance is +20 mm. More details >> 1.08.

Montageteil für LED / LED mounting

Montageteil für LED 50 / LED mounting 50
Material: Aluminium / material: aluminium

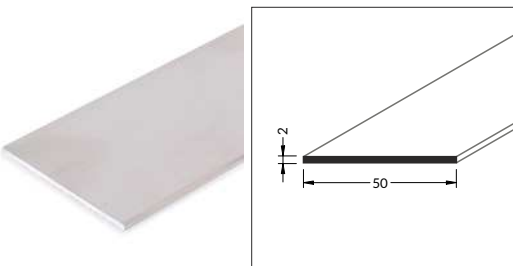

Rohaluminium

raw

9525090000

Artikelnummer = 1 Stück, Länge 2.000 mm
INDEX = 1 pc, length 2000 mm

Die zugänglichen Längen: 1000 mm, 2000 mm, 3000 mm, 4000 mm.
Die standardmäßige Toleranz der Länge von Profilen beträgt: +20 mm.
Mehr Informationen >> 1.08.
Available lengths: 1000 mm, 2000 mm, 3000 mm, 4000 mm.
The standard profile length tolerance is +20 mm. More details >> 1.08.

Die Abmessungen des Platzes für die Montage von LED Lichtquelle / Dimensions to install light source

PHIL53

Abdeckung C10 NARROW
C10 NARROW cover

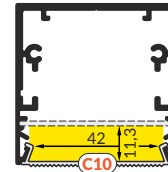
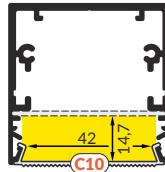
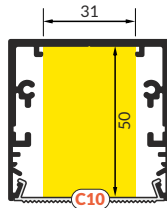

Abdeckung C10 OPAL
C10 OPAL cover



Aluminiumabdeckplatte C10
C10 aluminium cover



Abdeckung C10 WIDE
C10 WIDE cover

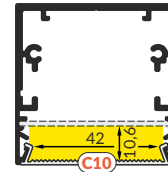
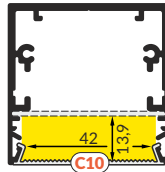
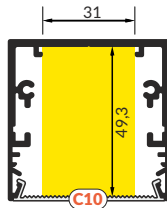

PHIL EINBAU / PHIL RECESSED

Abdeckung C10 NARROW
C10 NARROW cover

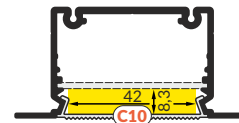
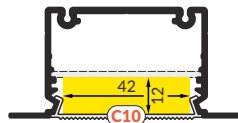
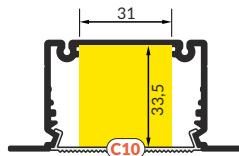

Abdeckung C10 OPAL
C10 OPAL cover



Aluminiumabdeckplatte C10
C10 aluminium cover



Abdeckung C10 WIDE
C10 WIDE cover

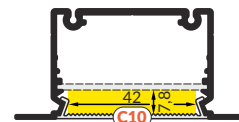
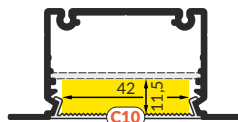
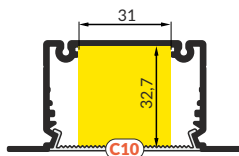

LOWI

Abdeckung C10 NARROW
C10 NARROW cover

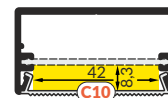
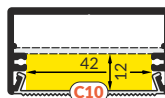
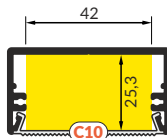

Abdeckung C10 OPAL
C10 OPAL cover



Aluminiumabdeckplatte C10
C10 aluminium cover



Abdeckung C10 WIDE
C10 WIDE cover

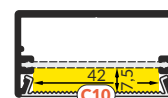
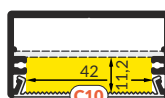
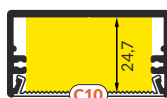

Abhängungen für die LED Profile / LED profile slings

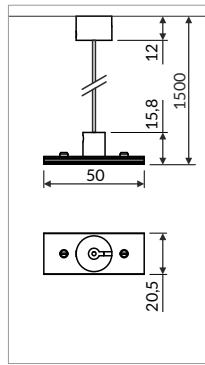

Abhängung SELV

SELV sling
50 V; 1500

weiß	silbern	schwarz
white	silver	black
9567120001	9567120022	9567120002

Artikelnummer = 1 Set = 2 Stück
INDEX = 1 set = 2 pcs.

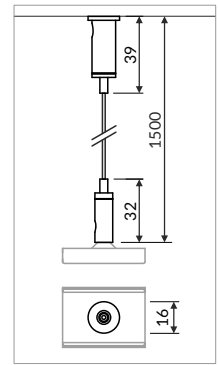

Abhängung für LED Profil-Halter

sling for LED mounting
1500

Chrom
chrome
9567140003

Artikelnummer = 1 Set = 2 Stück
INDEX = 1 set = 2 pcs.

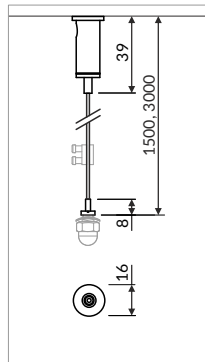

große Abhängung

large sling
Chrom 1500 mm
chrome 1500 mm

Chrom 1500 mm	Chrom 3000 mm
chrome 1500 mm	chrome 3000 mm
9543100003	9543110003

Artikelnummer = 1 Set = 2 Stück
INDEX = 1 set = 2 pcs.

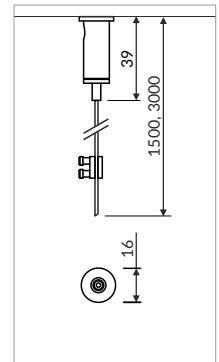

Abhängung SKB

SKB sling
Chrom 1500 mm
chrome 1500 mm

Chrom 1500 mm	Chrom 3000 mm
chrome 1500 mm	chrome 3000 mm
9567160003	9567170003

Artikelnummer = 1 Set = 1 Stück
INDEX = 1 set = 1 pcs.

Gelenkhalter für die LED Profile / tilted bracket for LED profiles

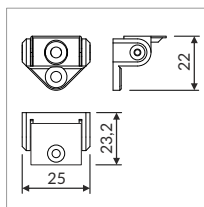

kompatibel mit den flexiblen Halter cone:
U4, U6, U, W, Y, Z
der Satz beinhaltet keine Halter
compatible with cone flexible mounting plates:
U4, U6, U, W, Y, Z
mounting plates not included

Gelenkhalter

weiß	silbern	schwarz	grau
white	silver	black	grey
9567230001	9567230040	9567230002	9567230022

Artikelnummer = 10 Sets = 20 Stück
INDEX = 10 sets = 20 pcs.

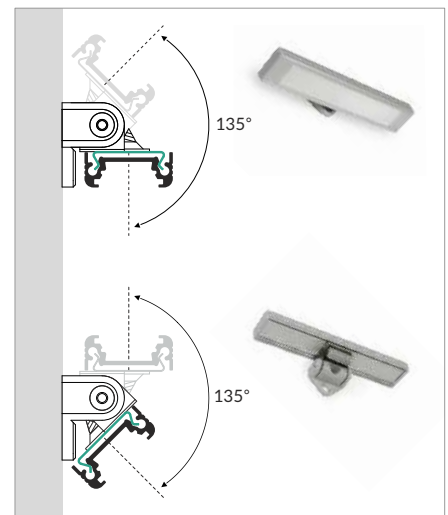

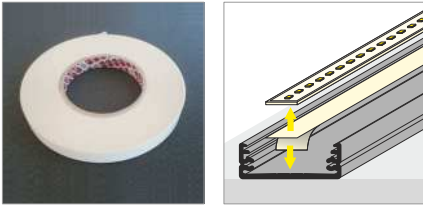

doppelseitiges leitendes Montageband
adhesive tape double-sided thermally conductive

15 mm x 50 m

9567990000

1 Rolle / 1 reel

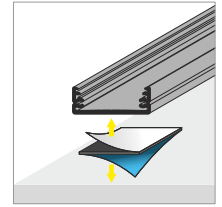
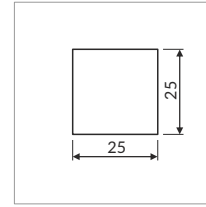
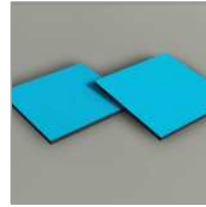

doppelseitiges, nicht leitendes Montageband
adhesive tape double-sided nonconductive

25 x 25 mm

9576340000

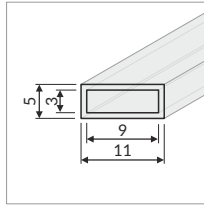

Silikonhülle für LED Streifen mit 8 mm
silicone housing for 8 mm LED strip

11 mm x 5 mm x 5 m

9567980000

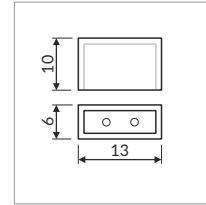

Endkappe für die Silikonhülle für LED Streifen mit 8 mm
ending for silicone housing for 8 mm LED strip

9567970000s

Artikelnummer = 1 Set
INDEX = 1 set,



der Gummi zur Reinigung der eloxierten Oberflächen
cleaning rubber for anodized surfaces

9525250000



ZUBEHÖR

Unsere Projektabteilung arbeitet ständig an der Erweiterung des Angebotes um weitere Komponenten, die die Montage vereinfachen und die Kombinations-, Verbindungs- und Montagemöglichkeiten vervielfachen.

Außer den Haltern, die mit mehreren Profilen kompatibel sind, haben viele Typen der Profile auch eigene Lösungen für mehr fortgeschrittene, spezielle Bedürfnisse. Unter den Zubehörteilen für LED Profile gibt es u.a. Endkappen, Abdeckungen, Halter, Ausleger, Verbinder, Klemmen, Abhängungen und viele andere.

ACCESSORIES

The design department is constantly working on expanding the offer with further components, which facilitate the assembly and multiply the possibilities of combinations, connections and assembly.

Apart from system mounting plates, which match different profiles, many collections also have dedicated solutions for more advanced, specialist needs. The accessories for LED profiles include, i.a.: endings, covers, mounting plates, holders, extension arms, connectors, clamps, slings and many more.



EU Industriedesign
EU-registered industrial design



PL
Hergestellt in Polen
Made in Poland

ENTWURF / FERTIGUNG

Alle Modelle sind registriert worden -
gesetzlich geschützt in ganz Europa.

DESING / PRODUCTION

All the designs are registered - legally
protected throughout the European
Union.



AUFBAUPROFİL / SURFACE

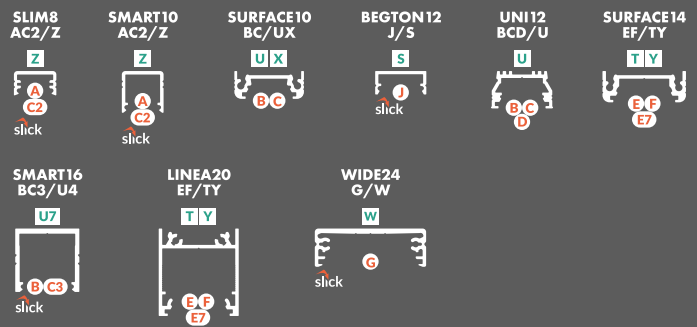

EINBAUPROFİL / RECESSED

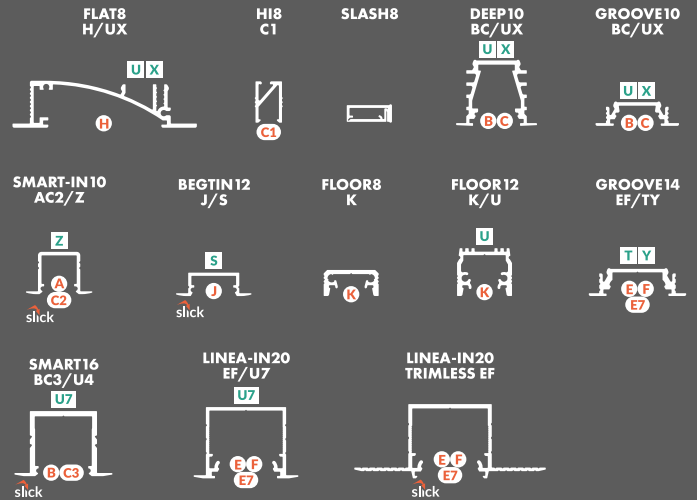

ECKPROFILE / CORNER

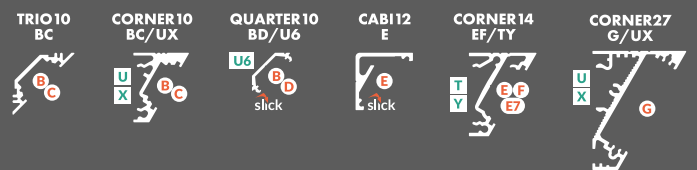

SPEZIELLE PROFILE / SPECIAL APPLICATION

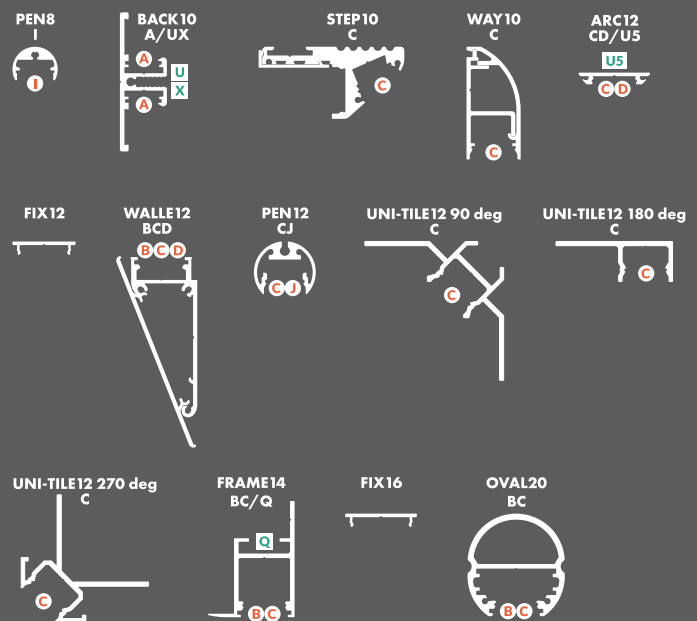

GLASKANTENPROFILE / GLASS APPLICATION

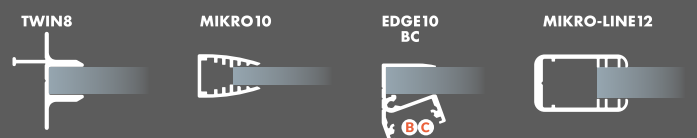



**Technische Leuchten
Rudolf von Prusky GmbH**

Heidfeld 2
D-33142 Büren

Telefon: +49 (0)2951 9900-0
Telefax: +49 (0)2951 9900-99
E-Mail: info@rvp.de
Internet: <https://www.rvp.de>

RvP Technische Leuchten ist ein Unternehmen von:
Rudolf von Prusky GmbH
Goethestraße 8
D-33330 Gütersloh